

## ***CONTINUED FROM PART 1***

### **INTRODUCTION**

In view of the recent amendment made in the Designs (Amendment) Rules, 2008 with effect from 17/06/2008, Publication of the matter relating to Designs is being published in the Official Journal of The Patent Office. This Journal is being published on weekly basis on every Friday covering the various proceedings on Designs as required according to the provisions of under Rule 22, 25, 27 and 39 of the Design (Amendment) Rules, 2008. All the enquiries on this Official Journal and other information as required by the public should be addressed to the Controller General of Patents, Designs & Trade Marks. Suggestions and comments are requested from all quarters so that the content can be enriched.

**CANCELLATION PROCEEDINGS**  
**under Section 19(1) of the Designs Act, 2000 &**  
**Designs (Amendment) Rules, 2008**

“Vishal Agricultural Works of Bhawanigarh Road, Near New Grain Market, Samana 147101, Punjab, India filed an application on 29/10/2009 for cancellation of registration of registered Design No. 212807 under class 15-03 titled as ‘Straw Walker for use in Track Harvester Combine’ in the name of Kartar Agro Industries (Pvt) Ltd..”

“Vishal Agricultural Works of Bhawanigarh Road, Near New Grain Market, Samana 147101, Punjab, India filed an application on 29/10/2009 for cancellation of registration of registered Design No. 212900 under class 15-03 titled as ‘Peg Tooth Threshing Cylinder for use in Track Harvester Combine’ in the name of Kartar Agro Industries (Pvt) Ltd..”



“Vishal Agricultural Works of Bhawanigarh Road, Near New Grain Market, Samana 147101, Punjab, India filed an application on 29/10/2009 for cancellation of registration of registered Design No. 216315 under class 15-99 titled as ‘Gear for use in Track Harvester Combine’ in the name of Kartar Agro Industries (Pvt) Ltd..”

“Vishal Agricultural Works of Bhawanigarh Road, Near New Grain Market, Samana 147101, Punjab, India filed an application on 29/10/2009 for cancellation of registration of registered Design No. 216316 under class 15-99 titled as ‘Gear Body for use in Track Harvester Combine’ in the name of Kartar Agro Industries (Pvt) Ltd..”

## REGISTRATION OF DESIGNS

The following designs have been registered. They are now open for public inspection. In the following each entry the Date of Registration is shown. The Priority Number, Priority Date and Priority Country are also shown.

<b>Design Number</b>	214677	
<b>Class</b>	12-16	
<b>1)Mahindra &amp; Mahindra Ltd.,</b> Mahindra Towers, 17-18, Patullous Road, Chennai-600 002, Tamil Nadu, India.		
<b>Date of Registration</b>	12/02/2008	
<b>Title</b>	Automotive	
<b>Priority NA</b>		
<b>Design Number</b>	215530	
<b>Class</b>	09-01	
<b>1)Wipro Limited.,</b> Doddakannahalli Village, Sarjapur Road, Bangalore-560 035, Karnataka, India.		
<b>Date of Registration</b>	27/03/2008	
<b>Title</b>	Bottle	
<b>Priority NA</b>		
<b>Design Number</b>	215721	
<b>Class</b>	23-01	
<b>1)Crompton Greaves Limited</b> 6th Floor, CG House, DR Annie Besant Road, Worli, Mumbai-400 030, Maharashtra, India.		
<b>Date of Registration</b>	31/03/2008	
<b>Title</b>	Air Circulating Drum	
<b>Priority NA</b>		

<b>Design Number</b>	215750	
<b>Class</b>	15-09	
<b>1)Crompton Greaves Limited</b> 6th Floor, CG House, DR Annie Besant Road, Worli, Mumbai-400 030, Maharashtra, India.		
<b>Date of Registration</b>	31/03/2008	
<b>Title</b>	Casting	
<b>Priority NA</b>		
<b>Design Number</b>	216353	
<b>Class</b>	07-08	
<b>1)S.S.VARSHNEY, MRS. RENU VARSHNEY AND MR. ATUL GUPTA.,</b> P.O.BOX NO. 146, I.T.I.ROAD, ALIGARH-202 001, UP, INDIA. 2)M/s Liberty Brass nternationale		
<b>Date of Registration</b>	16/05/2008	
<b>Title</b>	Fire Frets	
<b>Priority NA</b>		
<b>Design Number</b>	216354	
<b>Class</b>	07-08	
<b>1)S.S.VARSHNEY, MRS. RENU VARSHNEY AND MR. ATUL GUPTA.,</b> P.O.BOX NO. 146, I.T.I.ROAD, ALIGARH-202 001, UP, INDIA. 2)M/s Liberty Brass nternationale		
<b>Date of Registration</b>	16/05/2008	
<b>Title</b>	Fire Frets	
<b>Priority NA</b>		

<b>Design Number</b>	216456	
<b>Class</b>	14-99	
<b>1)Sony Computer Entertainment Inc.</b> 2-11-21, Azamino-Minami, Aoba-ku, Yokohama-shi, kanagawa-ken, Japan		
<b>Date of Registration</b>	28/05/2008	
<b>Title</b>	Supporting Base for Portbale Electronic Device	
<b>Priority</b>		
Priority Number	Date	Country
2007-035526	26/12/2007	Japan

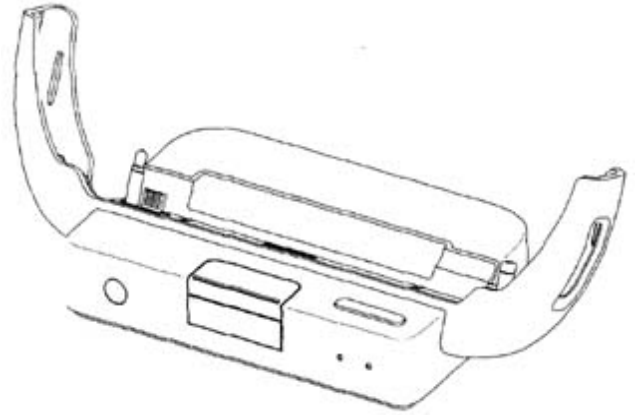



<b>Design Number</b>	216493	
<b>Class</b>	09-01	
<b>1)Mount Everest Mineral Water Limited</b> 5th Floor, ITTS House, 28, K. Dubash Marg, Mumbai-400 023, India.		
<b>Date of Registration</b>	30/05/2008	
<b>Title</b>	Bottle	
<b>Priority NA</b>		



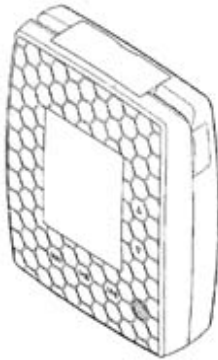
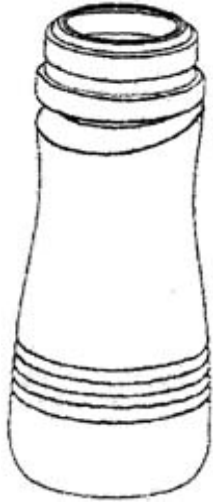

<b>Design Number</b>	216639	
<b>Class</b>	12-16	
<b>1)ASHOK LEYLAND LIMITED.,</b> 19, RAJAJI SALAI, CHENNAI 600 001, TAMILNADU, INDIA.		
<b>Date of Registration</b>	13/06/2008	
<b>Title</b>	Wind Deflector	
<b>Priority NA</b>		



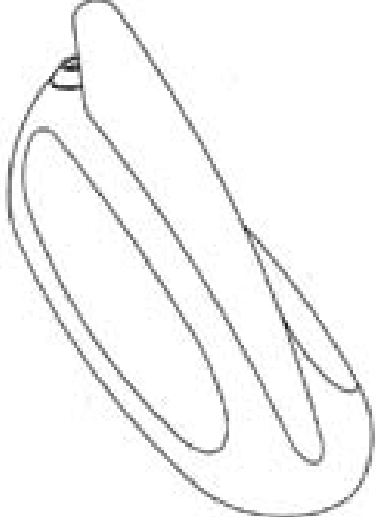

<b>Design Number</b>	216979		
<b>Class</b>	13-03		
<b>1)Chatsworth Products, Inc.,</b> 31425 Agoura Road Westlake Village CA 91361-4614, United States of America			
<b>Date of Registration</b>	02/07/2008		
<b>Title</b>	Cover for Cable Management Raceway		
<b>Priority</b>			
Priority Number	Date	Country	
29/302, 235	14/01/2008	U.S.A.	
<b>Design Number</b>	217062		
<b>Class</b>	14-03		
<b>1)Samsung Electronics Co., Ltd.</b> 416, Maetan-Dong, Yeongtong-Gu, Suwon-Si, Gyeonggi-Do, Korea.			
<b>Date of Registration</b>	09/07/2008		
<b>Title</b>	Portable Phone		
<b>Priority</b>			
Priority Number	Date	Country	
30-2008-0020410	15/05/2008	Korea(South)	
<b>Design Number</b>	217768		
<b>Class</b>	09-01		
<b>1)Wyeth</b> 5 Giralda Frms, Madison, New Jersey, 07940-0874, USA			
<b>Date of Registration</b>	13/08/2008		
<b>Title</b>	Bottle		
<b>Priority NA</b>			

<b>Design Number</b>	218023	
<b>Class</b>	12-11	
<b>1)Walkman World</b> Plot No. 3, Survey No. 329, Bhavnagar-Rajkot Highway, Navagam, (Kardej)Bhavnagar-364004, Gujarat, India		
<b>Date of Registration</b>	22/08/2008	
<b>Title</b>	Scooty	
<b>Priority NA</b>		

<b>Design Number</b>	218193		
<b>Class</b>	14-03		
<b>1)Robert Bosch GmbH</b> Postfach 30 02 02, 70442 Stuttgart, Germany			
<b>Date of Registration</b>	28/08/2008		
<b>Title</b>	Vehicle Mounted Antenna Housing		
<b>Priority</b>			
Priority Number	Date	Country	
000896667	29/02/2008	OHIM	

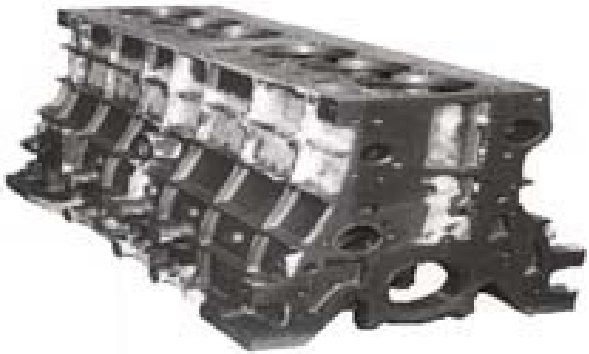

<b>Design Number</b>	218690		
<b>Class</b>	08-06		
<b>1)PMS Interprise</b> 15/16, Samrat Industrial Area, B/H S. T. Workshop, Gondal Road, Rajkot-360 004, Gujarat, India			
<b>Date of Registration</b>	23/09/2008		
<b>Title</b>	Handle		
<b>Priority NA</b>			

<b>Design Number</b>	218813	
<b>Class</b>	12-16	
<b>1)Mahindra &amp; Mahindra Ltd.</b> Gateway Building, Apollo Buner, Mumbai 400001, Maharashtra, India		
<b>Date of Registration</b>	29/09/2008	
<b>Title</b>	Engine Crankcase	
<b>Priority NA</b>		



<b>Design Number</b>	219118	
<b>Class</b>	06-03	
<b>1)Loom Crafts Furniture (India) Pvt. Ltd.,</b> A-7/98 & 99, South Side of G. T. Road, Industrial Area, Ghaziabad-201009, (U.P.), India		
<b>Date of Registration</b>	13/10/2008	
<b>Title</b>	Table	
<b>Priority NA</b>		

<b>Design Number</b>	219119	
<b>Class</b>	06-01	
<b>1)Loom Crafts Furniture (India) Pvt. Ltd.,</b> A-7/98 & 99, South Side of G. T. Road, Industrial Area, Ghaziabad- 201009, (U.P.), India		
<b>Date of Registration</b>	13/10/2008	
<b>Title</b>	Chair	
<b>Priority NA</b>		





<b>Design Number</b>	219120	
<b>Class</b>	06-03	
<b>1)Loom Crafts Furniture (India) Pvt. Ltd.,</b> A-7/98 & 99, South Side of G. T. Road, Industrial Area, Ghaziabad-201009, (U.P.), India		
<b>Date of Registration</b>	13/10/2008	
<b>Title</b>	Table	
<b>Priority NA</b>		
<b>Design Number</b>	219123	
<b>Class</b>	06-03	
<b>1)Loom Crafts Furniture (India) Pvt. Ltd.,</b> A-7/98 & 99, South Side of G. T. Road, Industrial Area, Ghaziabad-201009, (U.P.), India		
<b>Date of Registration</b>	13/10/2008	
<b>Title</b>	Table	
<b>Priority NA</b>		
<b>Design Number</b>	219299	
<b>Class</b>	28-03	
<b>1)Paris Luxurious Care Pvt. Ltd.</b> Baroda-Jambusar N. High way Road, At & Po. Dabhasa, Ta. Padra-391440, Dist. Baroda (Gujarat), India		
<b>Date of Registration</b>	17/10/2008	
<b>Title</b>	Comb	
<b>Priority NA</b>		

<b>Design Number</b>	219406	
<b>Class</b>	09-01	
<b>1)Chemco Plastic Industries pvt. Ltd.</b> 78, Virwani Indl. Estate, Off. W. E. Highway, Goregaon (E), Mumbai-400063, Maharashtra, India		
<b>Date of Registration</b>	23/10/2008	
<b>Title</b>	Bottle	
<b>Priority NA</b>		
<b>Design Number</b>	219448	
<b>Class</b>	11-01	
<b>1)M/s Sayani Metal Works</b> 13, Shripal Service Industrial Estate, Near Pawan Baug, Chincholi Phatak "x" Road, Malad (W), Mumbai-400064, India		
<b>Date of Registration</b>	27/10/2008	
<b>Title</b>	Ear Ring Set	
<b>Priority NA</b>		
<b>Design Number</b>	219449	
<b>Class</b>	11-01	
<b>1)M/s Sayani Metal Works</b> 13, Shripal Service Industrial Estate, Near Pawan Baug, Chincholi Phatak "x" Road, Malad (W), Mumbai-400064, India		
<b>Date of Registration</b>	27/10/2008	
<b>Title</b>	Ear Ring Set	
<b>Priority NA</b>		

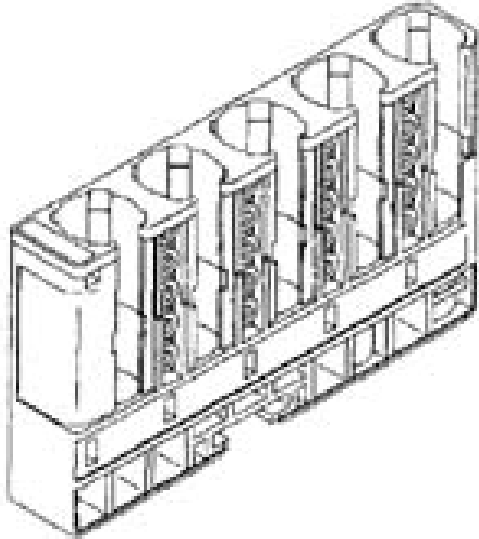
<b>Design Number</b>	219473	
<b>Class</b>	21-02	
<b>1)Sharma Exports</b> B-16, Sports & Surgical Complex, Kapurthala Road, Jalandhar-144 021 (Punjab) India		
<b>Date of Registration</b>	29/10/2008	
<b>Title</b>	Ball (Educational)	
<b>Priority NA</b>		
<b>Design Number</b>	219481	
<b>Class</b>	06-04	
<b>1)Axiom Consulting Private Limited</b> # 307, Shree Chambers, 1st Floor, 100ft Ring Road, Banashankari 3rd Stage, 4th Phase, 7th Block, Bangalore-560085, Karnataka, India		
<b>Date of Registration</b>	29/10/2008	
<b>Title</b>	Integrated Mobile Laundry System with Open Doors	
<b>Priority NA</b>		
<b>Design Number</b>	219482	
<b>Class</b>	06-04	
<b>1)Axiom Consulting Private Limited</b> # 307, Shree Chambers, 1st Floor, 100ft Ring Road, Banashankari 3rd Stage, 4th Phase, 7th Block, Bangalore-560085, Karnataka, India		
<b>Date of Registration</b>	29/10/2008	
<b>Title</b>	Integrated Mobile Laundry System with Close Doors	
<b>Priority NA</b>		



<b>Design Number</b>	219519	
<b>Class</b>	24-01	
<b>1)Hitachi High-Technologies Corporation</b> 1-24-14, Nishi Shinbashi, Minato-Ku, Tokyo, Japan		
<b>Date of Registration</b>	31/10/2008	
<b>Title</b>	Sample Rack	
<b>Priority NA</b>		



<b>Design Number</b>	219530	
<b>Class</b>	08-06	
<b>1)M/s Suyash Industries</b> 18, Atika Industrial Area, Dhebar Road South, Rajkot-360 002, Gujarat, India		
<b>Date of Registration</b>	04/11/2008	
<b>Title</b>	Handle	
<b>Priority NA</b>		

<b>Design Number</b>	219545	
<b>Class</b>	99-01	
<b>1)A. G. Biosystems Pvt. Ltd.</b> 6, Rajashree Apartments, Rukhmini Devi Colony, AOC Gate, Secunderabad-500026		
<b>Date of Registration</b>	04/11/2008	
<b>Title</b>	Moth Trap (Insect Monitoring Trap)	
<b>Priority NA</b>		

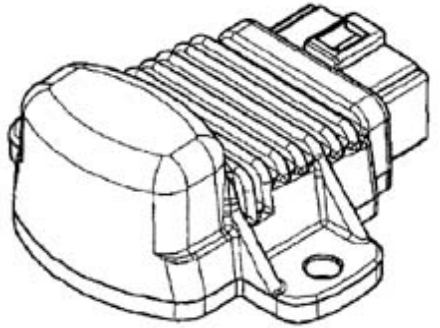

<b>Design Number</b>	219546	
<b>Class</b>	99-01	
<b>1)A. G. Biosystems Pvt. Ltd.</b> 6, Rajashree Apartments, Rukhmini Devi Colony, AOC Gate, Secunderabad-500026		
<b>Date of Registration</b>	04/11/2008	
<b>Title</b>	Funnel Trap (Insect Monitoring Trap)	
<b>Priority NA</b>		
<b>Design Number</b>	219621	
<b>Class</b>	08-06	
<b>1)PMS Interprise</b> 15/16, Samrat Industrial Area, B/H S. T. Workshop, Gondal Road, Rajkot-360 004, Gujarat, India		
<b>Date of Registration</b>	10/11/2008	
<b>Title</b>	Handle	
<b>Priority NA</b>		
<b>Design Number</b>	219680	
<b>Class</b>	06-03	
<b>1)Nilkamal Limited</b> Survey No.-354/2 & 354/3, Near Rakholi Bridge, Silvassa, Khanvel Road, Village Vasona, Silvassa (D & N. H.), U. T., India		
<b>Date of Registration</b>	14/11/2008	
<b>Title</b>	Table	
<b>Priority NA</b>		

<b>Design Number</b>	219681	
<b>Class</b>	06-03	
<b>1)Nilkamal Limited</b> Survey No.-354/2 & 354/3, Near Rakholi Bridge, Silvassa, Khanvel Road, Village Vasona, Silvassa (D & N. H.), U. T., India		
<b>Date of Registration</b>	14/11/2008	
<b>Title</b>	Table	
<b>Priority NA</b>		
<b>Design Number</b>		
<b>Design Number</b>	219683	
<b>Class</b>	06-03	
<b>1)Nilkamal Limited</b> Survey No.-354/2 & 354/3, Near Rakholi Bridge, Silvassa, Khanvel Road, Village Vasona, Silvassa (D & N. H.), U. T., India		
<b>Date of Registration</b>	14/11/2008	
<b>Title</b>	Table	
<b>Priority NA</b>		
<b>Design Number</b>		
<b>Design Number</b>	219684	
<b>Class</b>	06-03	
<b>1)Nilkamal Limited</b> Survey No.-354/2 & 354/3, Near Rakholi Bridge, Silvassa, Khanvel Road, Village Vasona, Silvassa (D & N. H.), U. T., India		
<b>Date of Registration</b>	14/11/2008	
<b>Title</b>	Table	
<b>Priority NA</b>		
<b>Design Number</b>		

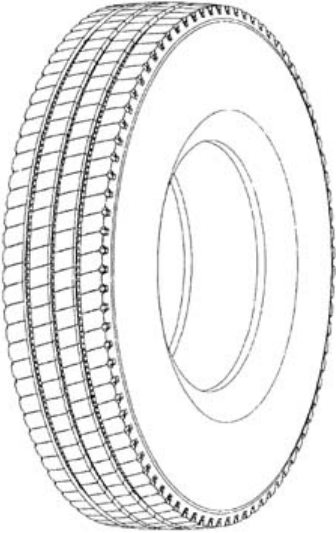

<b>Design Number</b>	219685	
<b>Class</b>	07-07	
<b>1)Nilkamal Limited</b> Survey No.-354/2 & 354/3, Near Rakholi Bridge, Silvassa, Khanvel Road, Village Vasona, Silvassa (D & N. H.), U. T., India		
<b>Date of Registration</b>	14/11/2008	
<b>Title</b>	Bucket	
<b>Priority NA</b>		
<b>Design Number</b>	219686	
<b>Class</b>	09-08	
<b>1)Nilkamal Limited</b> Survey No.-354/2 & 354/3, Near Rakholi Bridge, Silvassa, Khanvel Road, Village Vasona, Silvassa (D & N. H.), U. T., India		
<b>Date of Registration</b>	14/11/2008	
<b>Title</b>	Pallet	
<b>Priority NA</b>		
<b>Design Number</b>	219895	
<b>Class</b>	13-99	
<b>1)Shindengen Electric Manufacturing Co., Ltd.,</b> 2-1, Ohtemachi 2-chome, Chiyoda-Ku, Tokyo, Japan		
<b>Date of Registration</b>	28/11/2008	
<b>Title</b>	Case for Electric Circuit Equipment	
<b>Priority NA</b>		

<b>Design Number</b>	219932	
<b>Class</b>	05-05	
<b>1)Charming Apparatus (P) Ltd.,</b> 402-405, 1st Floor, Main Road, Chandni Chowk, Delhi-110006, India		
<b>Date of Registration</b>	01/12/2008	
<b>Title</b>	Textile Fabric	
<b>Priority NA</b>		
<b>Design Number</b>	219985	
<b>Class</b>	13-03	
<b>1)Larsen &amp; Toubro Limited</b> L & T House, Ballard Estate, Mumbai 400 001, Maharashtra, India		
<b>Date of Registration</b>	03/12/2008	
<b>Title</b>	Moulded Case Circuit Breaker	
<b>Priority NA</b>		
<b>Design Number</b>	219999	
<b>Class</b>	06-06	
<b>1)Hardware Concepts India Private Limited</b> 101 Laxmi Narayan Chs., Plot No.-353, S. K. Bole Road, Dadar (W), Mumbai-400028, Maharashtra, India		
<b>Date of Registration</b>	04/12/2008	
<b>Title</b>	Aluminium Profile	
<b>Priority NA</b>		



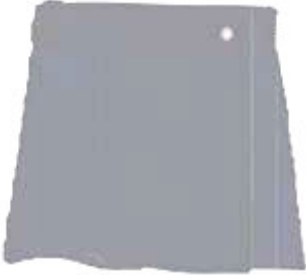
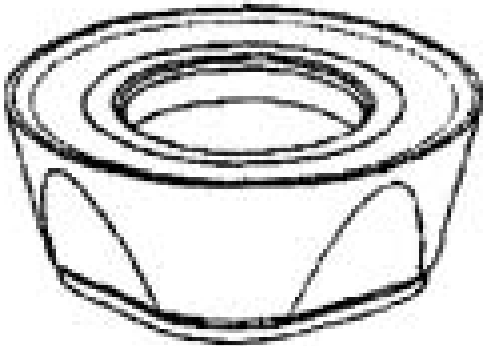

<b>Design Number</b>	220049		
<b>Class</b>	12-15		
<b>1)Societe DE Technologie Michelin</b> 23, rue Breschet-63000 clermont, ferrand, France			
<b>Date of Registration</b>	08/12/2008		
<b>Title</b>	Tyre		
<b>Priority</b>			
Priority Number	Date	Country	
08/2854	19/06/2008	France	
<b>Design Number</b>	220067		
<b>Class</b>	07-01		
<b>1)M/s Abhinav Electricals Industries</b> 3-B, Sherbanoo (Pil Court), 111 M. K. Road, Churchgate, Mumbai-400067, Maharashtra, India			
<b>Date of Registration</b>	08/12/2008		
<b>Title</b>	Glass		
<b>Priority NA</b>			
<b>Design Number</b>	220098		
<b>Class</b>	09-03		
<b>1)Raj Oil Mills Limited</b> 224, Bellasis Road, Mumbai-400008, Maharashtra, India			
<b>Date of Registration</b>	11/12/2008		
<b>Title</b>	Can		
<b>Priority NA</b>			



<b>Design Number</b>	220198		
<b>Class</b>	02-02		
<b>1)RBK International Academy</b> Opp. Indian Oil Nagar, Ghatkopar-Mankhurd Link Road, Chembur, Mumbai-400 088, Maharashtra, India			
<b>Date of Registration</b>	15/12/2008		
<b>Title</b>	Shirt		
<b>Priority NA</b>			
<b>Design Number</b>	220200		
<b>Class</b>	02-02		
<b>1)RBK International Academy</b> Opp. Indian Oil Nagar, Ghatkopar-Mankhurd Link Road, Chembur, Mumbai-400 088, Maharashtra, India			
<b>Date of Registration</b>	15/12/2008		
<b>Title</b>	Skirt		
<b>Priority NA</b>			
<b>Design Number</b>	220212		
<b>Class</b>	08-03		
<b>1)Seco Tools AB</b> S-737 82 Fagersta, Sweden			
<b>Date of Registration</b>	15/12/2008		
<b>Title</b>	Cutting Inserts		
<b>Priority</b>			
Priority Number	Date	Country	
000958558	26/06/2008	OHIM	

<b>Design Number</b>	220215		
<b>Class</b>	08-03		
<b>1)Seco Tools AB</b> S-737 82 Fagersta, Sweden			
<b>Date of Registration</b>	15/12/2008		
<b>Title</b>	Cutting Inserts		
<b>Priority</b>			
Priority Number	Date	Country	
000958558	26/06/2008	OHIM	
<b>Design Number</b>	220237		
<b>Class</b>	09-02		
<b>1)Cipet</b> TVK Industrial Area, Guindy, Chennai 600 032, TN, India			
<b>Date of Registration</b>	16/12/2008		
<b>Title</b>	Container		
<b>Priority NA</b>			
<b>Design Number</b>	220408		
<b>Class</b>	23-02		
<b>1)Tulshibhai Kanjibhai Patel</b> A-104, Sagun Castle, Behind Star Bazar, Satellite, Ahmedabad-380015, Gujarat, India			
<b>Date of Registration</b>	23/12/2008		
<b>Title</b>	Liquid Soap Dispenser		
<b>Priority NA</b>			

<b>Design Number</b>	220450	
<b>Class</b>	08-09	
<b>1)M/s Prince Enterprise</b> 80 Feet Road, 5/8 Ramnagar, Behind K. Rasiklal, Rajkot-360003, Gujarat, India		
<b>Date of Registration</b>	24/12/2008	
<b>Title</b>	Sofa Leg	
<b>Priority NA</b>		

<b>Design Number</b>	220460	
<b>Class</b>	08-06	
<b>1)Die-Cast Industries</b> Plot No. 209/210, N, Road, Aji G. I. D. C. Phase-II, Rajkot-360003, Gujarat State, India		
<b>Date of Registration</b>	24/12/2008	
<b>Title</b>	Handle	
<b>Priority NA</b>		

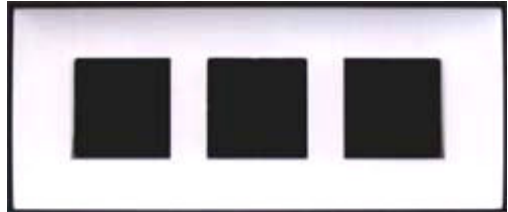
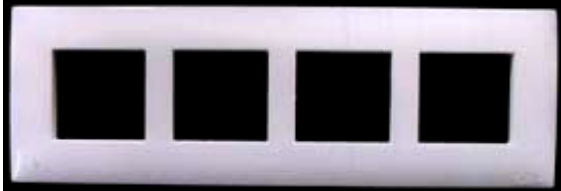
<b>Design Number</b>	220469	
<b>Class</b>	08-06	
<b>1)Die-Cast Industries</b> Plot No. 209/210, N, Road, Aji G. I. D. C. Phase-II, Rajkot-360003, Gujarat State, India		
<b>Date of Registration</b>	24/12/2008	
<b>Title</b>	Handle	
<b>Priority NA</b>		

<b>Design Number</b>	220515	
<b>Class</b>	13-03	
<b>1)Cosmo Electro Industries Pvt. Ltd.</b> 522, Laxmi Plaza, Laxmi Industrial Estate, New Link Road, Andheri (West), Mumbai-400053, Maharashtra, India		
<b>Date of Registration</b>	29/12/2008	
<b>Title</b>	Switch Plate	
<b>Priority NA</b>		
<b>Design Number</b>	220516	
<b>Class</b>	13-03	
<b>1)Cosmo Electro Industries Pvt. Ltd.</b> 522, Laxmi Plaza, Laxmi Industrial Estate, New Link Road, Andheri (West), Mumbai-400053, Maharashtra, India		
<b>Date of Registration</b>	29/12/2008	
<b>Title</b>	Switch Plate	
<b>Priority NA</b>		
<b>Design Number</b>	220595	
<b>Class</b>	06-07	
<b>1)MA Design India Private Limited</b> C-26. Sector, 63, Noida-201301, U.P. India		
<b>Date of Registration</b>	31/12/2008	
<b>Title</b>	Photo Frame	
<b>Priority NA</b>		

<b>Design Number</b>	221134							
<b>Class</b>	26-05							
<b>1)Wipro Limited.,</b> Doddakannahalli Village, Sarjapur Road, Bangalore-560 035, Karnataka, India.								
<b>Date of Registration</b>	10/02/2009							
<b>Title</b>	Wall Mounted Luminaire							
<b>Priority NA</b>								
<b>Design Number</b>	221143							
<b>Class</b>	14-03							
<b>1)Sony Ericsson Mobile Communications AB</b> Se-221 88, Lund, Sweden.								
<b>Date of Registration</b>	11/02/2009							
<b>Title</b>	Mobile Phone							
<b>Priority</b>								
<table border="1"> <thead> <tr> <th>Priority Number</th> <th>Date</th> <th>Country</th> </tr> </thead> <tbody> <tr> <td>000986724-0001</td> <td>14/08/2008</td> <td>OHIM</td> </tr> </tbody> </table>			Priority Number	Date	Country	000986724-0001	14/08/2008	OHIM
Priority Number	Date	Country						
000986724-0001	14/08/2008	OHIM						
<b>Design Number</b>	221144							
<b>Class</b>	14-03							
<b>1)Sony Ericsson Mobile Communications AB.,</b> SE-221 88, Lund, Sweden.								
<b>Date of Registration</b>	11/02/2009							
<b>Title</b>	Mobile Phone-Closed							
<b>Priority</b>								
<table border="1"> <thead> <tr> <th>Priority Number</th> <th>Date</th> <th>Country</th> </tr> </thead> <tbody> <tr> <td>000986724-0002</td> <td>14/08/2008</td> <td>OHIM</td> </tr> </tbody> </table>			Priority Number	Date	Country	000986724-0002	14/08/2008	OHIM
Priority Number	Date	Country						
000986724-0002	14/08/2008	OHIM						

<b>Design Number</b>	221349		
<b>Class</b>	26-06		
<b>1)GM Global Technology Operations, Inc.</b> 300 Renaissance Center, Detroit, Michigan 48265-3000, USA.			
<b>Date of Registration</b>	23/02/2009		
<b>Title</b>	Head Lamp of Car		
<b>Priority</b>			
Priority Number	Date	Country	
30-2008-0050581	25/11/2008	Korea(South)	