

CONTINUED FROM PART 1

INTRODUCTION

In view of the recent amendment made in the Designs (Amendment) Rules, 2008 with effect from 17/06/2008, Publication of the matter relating to Designs is being published in the Official Journal of The Patent Office. This Journal is being published on weekly basis on every Friday covering the various proceedings on Designs as required according to the provisions of under Rule 22, 25, 27 and 39 of the Design (Amendment) Rules, 2008. All the enquiries on this Official Journal and other information as required by the public should be addressed to the Controller General of Patents, Designs & Trade Marks. Suggestions and comments are requested from all quarters so that the content can be enriched.

CANCELLATION PROCEEDINGS
under Section 19 of the Designs Act, 2000

“The Ld. Asstt. Controller of Patents & Designs passed an order on 19/5/2010 to dismiss the petition filed by **M/s. S.N. Kapoor Exports**, Khawasji Ka Bagh, Amer Road, Jaipur-302002 on 27/12/2006 for cancellation of registration of the registered Design No. **193813** dated 20/11/2003 under class 06-11 titled as ‘Carpet’ in the name of Mahesh Kumar Choudhary & Mrs. Basu Devi Choudhary, both Indian partners, trading as M/s. Saraswati Exports, an Indian partnership firm of 3 Ganesh Colony, behind Golimar Garden, Amer Road, Jaipur-302002, Rajasthan, India.”

CANCELLATION PROCEEDINGS
under Section 19(1) of the Designs Act, 2000 &
Designs Rules, 2008 as amended by (Amendment) Rules, 2008

“M/s. Escorts Construction Equipment Ltd. of Plot No.219, Sector 58, Ballabgarh, Dist. Faridabad, Haryana, India filed an application on 22/4/2010 for cancellation of registration of registered Design No. **200004** under class 12-16 titled as ‘Front Grill of a Backhoe Loader’ in the name of JCB India Limited.”

“M/s. Escorts Construction Equipment Ltd. of Plot No.219, Sector 58, Ballabgarh, Dist. Faridabad, Haryana, India filed an application on 22/4/2010 for cancellation of registration of registered Design No. **200005** under class 12-16 titled as ‘Bucket of a Backhoe Loader’ in the name of JCB India Limited.”

“M/s. Escorts Construction Equipment Ltd. of Plot No.219, Sector 58, Ballabgarh, Dist. Faridabad, Haryana, India filed an application on 22/4/2010 for cancellation of registration of registered Design No. **200006** under class 12-16 titled as ‘Bonnet of a Backhoe Loader’ in the name of JCB India Limited.”

“M/s. Escorts Construction Equipment Ltd. of Plot No.219, Sector 58, Ballabgarh, Dist. Faridabad, Haryana, India filed an application on 22/4/2010 for cancellation of registration of registered Design No. **200007** under class 12-16 titled as ‘Hydraulic Tank of a Backhoe Loader’ in the name of JCB India Limited.”

“M/s. Escorts Construction Equipment Ltd. of Plot No.219, Sector 58, Ballabgarh, Dist. Faridabad, Haryana, India filed an application on 22/4/2010 for cancellation of registration of registered Design No. **200008** under class 12-16 titled as ‘Fender of a Backhoe Loader’ in the name of JCB India Limited.”

“M/s. Escorts Construction Equipment Ltd. of Plot No.219, Sector 58, Ballabgarh, Dist. Faridabad, Haryana, India filed an application on 22/4/2010 for cancellation of registration of registered Design No. **200009** under class 12-16 titled as ‘Diesel Tank of a Backhoe Loader’ in the name of JCB India Limited.”

“M/s. Escorts Construction Equipment Ltd. of Plot No.219, Sector 58, Ballabgarh, Dist. Faridabad, Haryana, India filed an application on 22/4/2010 for cancellation of registration of registered Design No. **200010** under class 12-16 titled as ‘Cabin Exterior of a Backhoe Loader’ in the name of JCB India Limited.”

“M/s. Escorts Construction Equipment Ltd. of Plot No.219, Sector 58, Ballabgarh, Dist. Faridabad, Haryana, India filed an application on 22/4/2010 for cancellation of registration of registered Design No. **200011** under class 06-01 titled as ‘Seat of a Backhoe Loader’ in the name of JCB India Limited.”

“M/s. Escorts Construction Equipment Ltd. of Plot No.219, Sector 58, Ballabgarh, Dist. Faridabad, Haryana, India filed an application on 22/4/2010 for cancellation of registration of registered Design No. **200012** under class 12-16 titled as ‘Excavator Control Lever of a Backhoe Loader’ in the name of JCB India Limited.”

“M/s. Escorts Construction Equipment Ltd. of Plot No.219, Sector 58, Ballabgarh, Dist. Faridabad, Haryana, India filed an application on 22/4/2010 for cancellation of registration of registered Design No. **200013** under class 12-16 titled as ‘Side Console of a Backhoe Loader’ in the name of JCB India Limited.”

“M/s. Escorts Construction Equipment Ltd. of Plot No.219, Sector 58, Ballabhgarh, Dist. Faridabad, Haryana, India filed an application on 22/4/2010 for cancellation of registration of registered Design No. **200014** under class 12-16 titled as ‘Front Console of a Backhoe Loader’ in the name of JCB India Limited.”

“M/s. Escorts Construction Equipment Ltd. of Plot No.219, Sector 58, Ballabhgarh, Dist. Faridabad, Haryana, India filed an application on 22/4/2010 for cancellation of registration of registered Design No. **200016** under class 12-16 titled as ‘Stabilizer Leg of a Backhoe Loader’ in the name of JCB India Limited.”

“M/s. Escorts Construction Equipment Ltd. of Plot No.219, Sector 58, Ballabhgarh, Dist. Faridabad, Haryana, India filed an application on 22/4/2010 for cancellation of registration of registered Design No. **200017** under class 12-16 titled as ‘Dipper of a Backhoe Loader’ in the name of JCB India Limited.”

“M/s. Escorts Construction Equipment Ltd. of Plot No.219, Sector 58, Ballabhgarh, Dist. Faridabad, Haryana, India filed an application on 22/4/2010 for cancellation of registration of registered Design No. **200018** under class 12-16 titled as ‘Bucket of a Backhoe Loader’ in the name of JCB India Limited.”

“M/s. Escorts Construction Equipment Ltd. of Plot No.219, Sector 58, Ballabhgarh, Dist. Faridabad, Haryana, India filed an application on 22/4/2010 for cancellation of registration of registered Design No. **200019** under class 12-16 titled as ‘Boom of a Backhoe Loader’ in the name of JCB India Limited.”



“M/s. Escorts Construction Equipment Ltd. of Plot No.219, Sector 58, Ballabhgarh, Dist. Faridabad, Haryana, India filed an application on 22/4/2010 for cancellation of registration of registered Design No. **200020** under class 12-16 titled as ‘Loader Arm of a Backhoe Loader’ in the name of JCB India Limited.”



RESTORATION OF LAPSED DESIGN
UNDER SECTION 12 (2) OF THE DESIGNS ACT, 2000



The request for restoration of Design No. 178857 dated 22.10.2009 made under section 12(2) of the Designs Act, 2000 in the name of **FLORA BALL PENS PVT. LTD.**, an Indian Pvt. Ltd. company of 22, Bonfield Lane, Calcutta – 700 001, West Bengal, India has been allowed and restored vide Controller Order No. 178857/REST/1/05-D. dated 18th May, 2010.

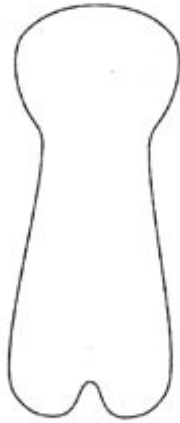

REGISTRATION OF DESIGNS

The following designs have been registered. They are now open for public inspection. In the following each entry the Date of Registration is shown. The Priority Number, Priority Date and Priority Country are also shown.

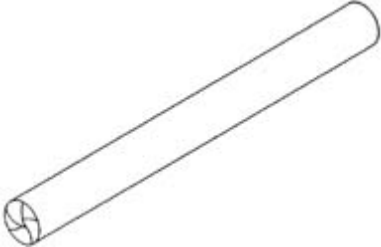

Design Number	208086		
Class	14-03		
1) Samsung Electronics Co., Ltd. 416, Maetan-Dong, Yeongtong-GU, Suwon-SI, Gyeonggi-DO, Republic of Korea			
Date of Registration	25/01/2007		
Title	Mobile Phone		
Priority			
Priority Number	Date	Country	
30-2006-0047763	01/12/2006	Republic of Korea	
Design Number	212025		
Class	07-01		
1) The Coca-Cola Company One Coca-Cola Plaza NW, Atlanta, Georgia 30313, USA			
Date of Registration	22/08/2007		
Title	Cooler		
Priority			
Priority Number	Date	Country	
29/278,701	06/04/2007	U.S.A.	
Design Number	213070		
Class	26-05		
1) Led Lighting Fixtures, Inc., 617 Davis Drive, Suite 200, Keystone Technology, Park VI, Morrisville, NC 27560, USA			
Date of Registration	26/10/2007		
Title	Accessory for a Lighting Device		
Priority			
Priority Number	Date	Country	
29/279,357	27/04/2007	U.S.A.	

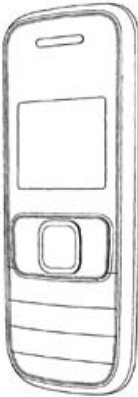
Design Number	214485		
Class	24-04		
1)SCA Hygiene Products AB., SE-405 03 Goteborg, Sweden.			
Date of Registration	30/01/2008		
Title	Panty Liner		
Priority			
Priority Number	Date	Country	
000790415-0001	04/09/2007	OHIM	
Design Number	214486		
Class	24-04		
1)SCA Hygiene Products Ab., SE-405 03 Goteborg, Sweden.			
Date of Registration	30/01/2008		
Title	Panty Liner		
Priority			
Priority Number	Date	Country	
000790415-0001	04/09/2007	OHIM	
Design Number	214547		
Class	12-08		
1)Volkswagen AG, Brieffach 1701/0, 38436 Wolfsburg, Germany.			
Date of Registration	05/02/2008		
Title	Motor Car		
Priority			
Priority Number	Date	Country	
000769948	06/08/2007	OHIM	

Design Number	214640		
Class	27-99		
1)British American Tobacco (Investments) Limited 1 Water Street, London, WC2R 3LA, UK			
Date of Registration	08/02/2008		
Title	Smoking Article		
Priority			
Priority Number	Date	Country	
000778220	10/08/2007	OHIM	
Design Number	215166		
Class	14-03		
1)Mitsubishi Heavy Industries, Ltd., 16-05, Konan 2-Chome, Minato-Ku, Tokyo, 108-8215, Japan.			
Date of Registration	07/03/2008		
Title	Card Holder for IC Cards Used for Electronic Toll Collection Machine		
Priority			
Priority Number	Date	Country	
2007-025011	14/09/2007	Japan	
Design Number	216278		
Class	14-03		
1)Nokia Corporation., Keilalahdentie 4, Fin-02150 Espoo, Finland.			
Date of Registration	12/05/2008		
Title	Handset		
Priority			
Priority Number	Date	Country	
29/297,553	13/11/2007	U.S.A.	

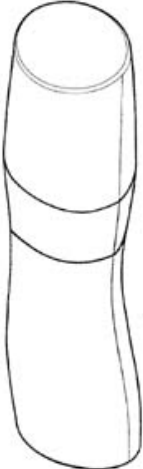
Design Number	216943		
Class	14-03		
1)Nokia Corporation Keilalahdentie 4 Fin-02150 Espoo Finland			
Date of Registration	30/06/2008		
Title	Front Cover of A Handset		
Priority			
Priority Number	Date	Country	
29/299,802	04/01/2008	U.S.A.	
Design Number	217592		
Class	14-03		
1)Nokia Corporation Keilalahdentie 4 Fin-02150 Espoo Finland			
Date of Registration	07/08/2008		
Title	Handset		
Priority			
Priority Number	Date	Country	
29/303, 456	08/02/2008	U.S.A.	
Design Number	219013		
Class	13-03		
1)Havells India Limited 1/7, Ram Kishore Road, Civil Line, Delhi-110054, India			
Date of Registration	07/10/2008		
Title	Miniature Circuit Breaker (MCB)		
Priority NA			

Design Number	219343		
Class	23-02		
1)Keramik Holding AG Laufen Wahlenstrasse 46, 4242 Laufen, Switzerland			
Date of Registration	20/10/2008		
Title	Wash Basin		
Priority			
Priority Number	Date	Country	
2008-00376	18/04/2008	Switzerland	
Design Number			
219388			
Class	07-05		
1)Kiwi European Holdings B.V. Vleutensevaart 100 3532 Ad Utrecht The Netherlands			
Date of Registration	21/10/2008		
Title	Device For Applying Shoe Polish		
Priority			
Priority Number	Date	Country	
000967468-0001	09/07/2008	OHIM	
Design Number			
219520			
Class	24-01		
1)Hitachi High-technologies Corporation 1-24-14, Nishi Shinbashi, Minato-Ku, Tokyo, Japan			
Date of Registration	31/10/2008		
Title	Adapter for a Sample Rack		
Priority			
Priority Number	Date	Country	
2008-018580	18/07/2008	Japan	

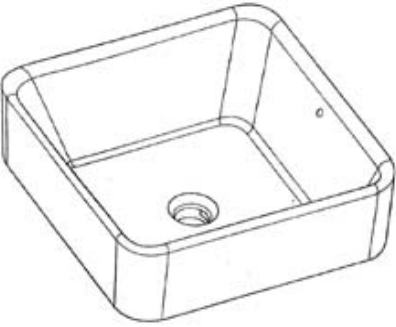
Design Number	219589			
Class	12-15			
1) Bridgestone Corporation 10-1, Kyobashi 1-chome, Chuo-ku, Tokyo, Japan				
Date of Registration	07/11/2008			
Title	Automobile Tire			
Priority				
Priority Number	Date	Country		
2008-011479	07/05/2008	Japan		
Design Number	219592			
Class	11-01			
1) De Beers Centenary AG Alpenstrasse 5, 6000 Luzern 6, Switzerland				
Date of Registration	07/11/2008			
Title	Ring			
Priority				
Priority Number	Date	Country		
000963673	02/07/2008	OHIM		
Design Number	219877			
Class	23-02			
1) Kohler (China) Investment Co., Ltd., 19/F, Shanghai Square, 138 Hua Hai Road, Shanghai, China				
Date of Registration	26/11/2008			
Title	Sink			
Priority				
Priority Number	Date	Country		
200830127669.2	30/05/2008	China		

Design Number	219959	
Class	14-03	
1)Nokia Corporation Keilalahdentie 4 Fin-02150 Espoo Finland		
Date of Registration	01/12/2008	
Title	Handset	
Priority		
Priority Number	Date	Country
29/324, 479	12/09/2008	U.S.A.





Design Number	219960	
Class	14-03	
1)Nokia Corporation Keilalahdentie 4 Fin-02150 Espoo Finland		
Date of Registration	01/12/2008	
Title	Handset	
Priority		
Priority Number	Date	Country
29/324, 477	12/09/2008	U.S.A.



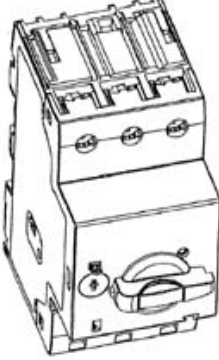

Design Number	219962	
Class	14-03	
1)Nokia Corporation Keilalahdentie 4 Fin-02150 Espoo Finland		
Date of Registration	01/12/2008	
Title	Handset	
Priority		
Priority Number	Date	Country
29/324, 224	09/09/2008	U.S.A.

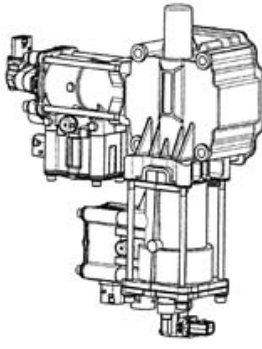
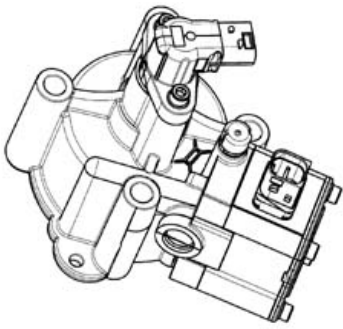
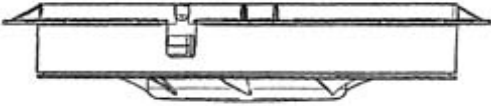

Design Number	220607		
Class	07-06		
1)MA Design India Private Limited C-26, Sector, 63, Noida-201301, U.P., India			
Date of Registration	31/12/2008		
Title	Glass Holder		
Priority NA			
Design Number	220636		
Class	13-03		
1)Moeller Gmbh., Hein-Moeller-Str. 7-11, 53115, Bonn, Germany.			
Date of Registration	01/01/2009		
Title	Motorstarter With Toggle		
Priority			
Priority Number	Date	Country	
001040414	17/11/2008	OHIM	
Design Number	220724		
Class	14-02		
1)Sony Computer Entertainment Inc., 2-6-21, Minami-Aoyama, Minato-Ku, Tokyo 107-0062, Japan.			
Date of Registration	09/01/2009		
Title	Keyboard		
Priority			
Priority Number	Date	Country	
2008-021209	19/08/2008	Japan	

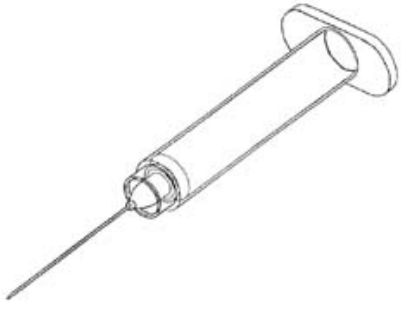
Design Number	220733		
Class	12-16		
1)Wabco Gmbh., Am Lindener Hafen 21, 30453, Hannover, Germany.			
Date of Registration	09/01/2009		
Title	Gearbox Actuator		
Priority			
Priority Number	Date	Country	
DE 40 2008 003 257.8	10/07/2008	Germany	
Design Number	220735		
Class	12-16		
1)Wabco Gmbh., Am Lindener Hafen 21, 30453, Hannover, Germany.			
Date of Registration	09/01/2009		
Title	Range Cylinder		
Priority			
Priority Number	Date	Country	
DE 40 2008 003 255.1	10/07/2008	Germany	
Design Number	220745		
Class	23-04		
1)Spal Automotive S.R.L., Via Per Carpi, 26/B, 42015 Correggio (Reggio Emilia), Italy.			
Date of Registration	12/01/2009		
Title	Electric Fans Unit		
Priority			
Priority Number	Date	Country	
000970389	15/07/2008	EUROPEAN UNION	

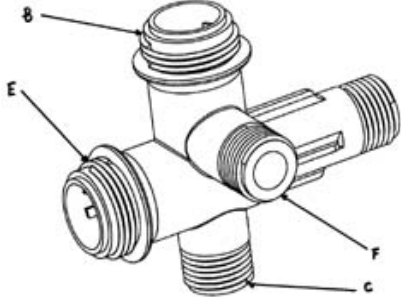
Design Number	220746	
Class	24-02	
1)MK Limited 439-8, Gagyo-Ri, Songak-Myeon, Dangjin-Gun, Chungcheongnam-Do, 348-821, Korea.		
Date of Registration	12/01/2009	
Title	Single Ject Auto Disable Syringe	
Priority NA		
Design Number	220757	
Class	26-03	
1)Crompton Greaves Limited, 6th Floor, CG House, Dr Annie Besant Road, Worli, Mumbai 400030, Maharashtra, India		
Date of Registration	13/01/2009	
Title	Lighting Fixture	
Priority NA		
Design Number	220769	
Class	23-01	
1)Watertec (Malaysia) Sdn Bhd., Lot 6 Jalan Halba 16/16, Section 16, 40200 Shah Alam, Selangor, Malaysia.		
Date of Registration	14/01/2009	
Title	Valve Body	
Priority NA		

Design Number	220776
Class	23-01
1)Watertec (Malaysia) Sdn Bhd., Lot 6 Jalan Halba 16/16, Section 16, 40200 Shah Alam, Selangor, Malaysia.	
Date of Registration	14/01/2009
Title	Valve
Priority NA	

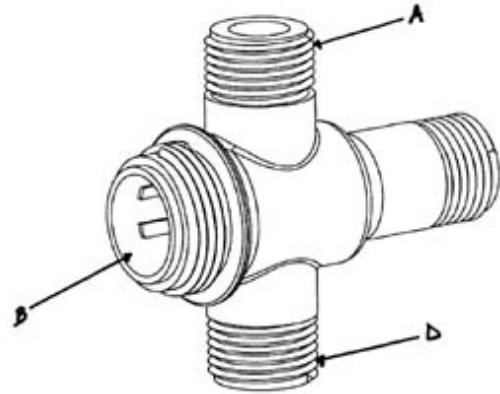

Design Number	220788
Class	09-03
1)PROF. (DR.) S.K.NAYAK & N. DURAI, CIPET, TVK INDUSTRIAL AREA, GUINDY, CHENNAI-600032, TN, INDIA. 2)Central Institute of Plastics Engineering & Technology,	
Date of Registration	15/01/2009
Title	Tablet Container
Priority NA	

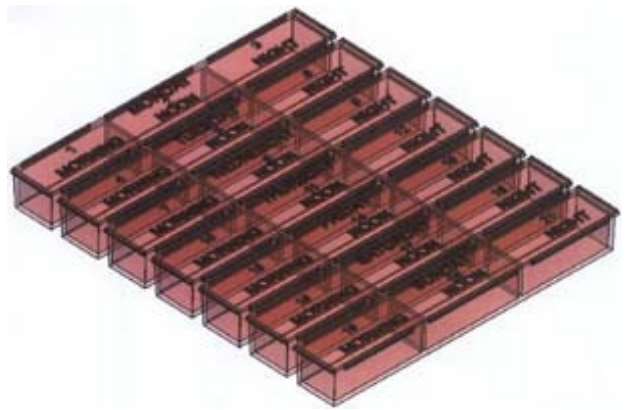

Design Number	220883	
Class	09-99	
1)LBP Manufacturing, Inc., 1325, South Cicero Avenue, Cicero, Illinois-60804, USA		
Date of Registration	21/01/2009	
Title	Protective Sleeve	
Priority		
Priority Number	Date	Country
29/321,925	25/07/2008	U.S.A.



Design Number	221003	
Class	12-08	
1)Toyota Jidosha Kabushiki Kaisha 1, Toyota-cho, Toyota-shi, Aichi-Ken, 471-8571, Japan		
Date of Registration	30/01/2009	
Title	Automobile	
Priority		
Priority Number	Date	Country
2008-024920	29/09/2008	Japan



Design Number	221085	
Class	19-99	
1)Kores Holding Zug AG Baarerstrasse 112, 6302 Zug, Switzerland.		
Date of Registration	06/02/2009	
Title	Bookmarker	
Priority		
Priority Number	Date	Country
MU 659/2008	07/08/2008	Austria

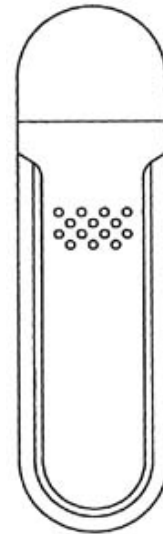



Design Number	221176	
Class	15-02	
1)Crompton Greaves Limited, 6th Floor, CG House, Dr Annie Besant Road, Worli, Mumbai 400030, Maharashtra, India		
Date of Registration	12/02/2009	
Title	Pump	
Priority NA		

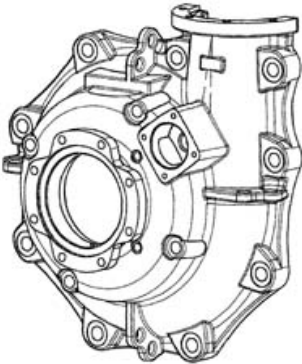
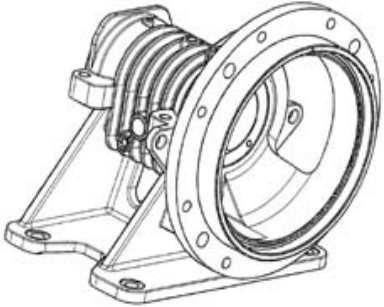



Design Number	221178		
Class	23-04		
1)Crompton Greaves Limited., 6th Floor, Cg House, Dr Annie Besant Road, Worli, Mumbai-400 030, Maharashtra, India.			
Date of Registration	12/02/2009		
Title	EXHAUST FAN		
Priority NA			
Design Number	221196		
Class	15-02		
1)Weir Minerals Australia Ltd., 1 Marden Street, Artarmon, New South Wales 2064, Australia.			
Date of Registration	13/02/2009		
Title	Pump Casing Component		
Priority			
Priority Number	Date	Country	
13898/2008	14/08/2008	Australia	
Design Number	221197		
Class	15-02		
1)Weir Minerals Australia Ltd., 1 Marden Street, Artarmon, New South Wales 2064, Australia.			
Date of Registration	13/02/2009		
Title	Frame For Pump		
Priority			
Priority Number	Date	Country	
13897/2008	14/08/2008	Australia	

Design Number	221244		
Class	23-02		
1)Hindustan Sanitaryware & Industries Limited., Bahadurgarh-124507, Dist. Jhajjar, Haryana, India.			
Date of Registration	16/02/2009		
Title	Pedestal		
Priority NA			
Design Number	221324		
Class	06-01		
1)Wipro Limited., Doddakannelli, Sarjapur Road, Bangalore-560 035, Karnataka, India.			
Date of Registration	19/02/2009		
Title	Chair		
Priority NA			
Design Number	221531		
Class	14-03		
1)Motorola, Inc. 1303 East Algonquin Road, Schaumburg, Illinois 60196, USA			
Date of Registration	05/03/2009		
Title	Audio Device		
Priority			
Priority Number	Date	Country	
29/324,602	16/09/2008	U.S.A.	

Design Number	221585	
Class	09-01	
1)Crystal Brook Neha Apartment, S.J.Road, Block-7A, Athgaon,Guwahati-1, Assam, India.		
Date of Registration	09/03/2009	
Title	Bottle	
Priority NA		

Design Number	221641	
Class	24-02	
1)Sanofi-Aventis Deutschland GmbH., Bruningstrasse 50, 65929 Frankfurt, Germany.		
Date of Registration	13/03/2009	
Title	Medical Injector	
Priority		
Priority Number	Date	Country
001002034-0004	15/09/2008	OHIM

Design Number	221695	
Class	09-01	
1)Nayasa Homeware Survey No. 367/16 & 378/2 Kachigam, Nani Daman, Daman-396 210, Daman Union Territories, India.		
Date of Registration	16/03/2009	
Title	Water Bottle	
Priority NA		

Design Number	221726	
Class	13-01	
1)Crompton Greaves Limited, 6th Floor, CG House, Dr Annie Besant Road, Worli, Mumbai 400030, Maharashtra, India		
Date of Registration	17/03/2009	
Title	Motor	
Priority NA		