

CONTINUED FROM PART- 2

INTRODUCTION



In view of the recent amendment made in the Designs (Amendment) Rules, 2008 with effect from 17/06/2008, Publication of the matter relating to Designs is being published in the Official Journal of The Patent Office. This Journal is being published on weekly basis on every Friday covering the various proceedings on Designs as required according to the provisions of under Rule 22, 25, 27 and 39 of the Design (Amendment) Rules, 2008. All the enquiries on this Official Journal and other information as required by the public should be addressed to the Controller General of Patents, Designs & Trade Marks. Suggestions and comments are requested from all quarters so that the content can be enriched.

CANCELLATION PROCEEDINGS
under Section 19(1) of the Designs Act, 2000 &
Designs Rules, 2001 as amended by (Amendment) Rules, 2008

“Shri Bharatbhai Vrajlal Bhanderi and Shri Hiteshbhai Vrajlal Bhanderi, both situated at Mavdi Main Road, Anand Bunglow Chowk, Surbhi Complex, 1st Floor, Shop No.2, Rajkot-360006, Gujarat, India filed an application on 24/3/2010 for cancellation of registration of registered Design No. **224326** under class 13-03 titled as ‘Modular Switch Plate’ in the name of Nestone Electronics Private Limited.”

REGISTRATION OF DESIGNS

The following designs have been registered. They are now open for public inspection. In the following each entry the Date of Registration is shown. The Priority Number, Priority Date and Priority Country are also shown.

Design Number	209352		
Class	13-03		
1)Ajanta Limited Orpat Industrial Estate, Rajkot Highway, P.B. No. 115, Morbi-363641, State of Gujarat, India.			
Date of Registration	03/04/2007		
Title	Socket And Switch		
Priority NA			
Design Number	215160		
Class	13-02		
1)MICROTEK INTERNATIONAL PVT. LTD., D-7, UDYOG NAGAR, MAIN ROHTAK ROAD, NEW DELHI-110 041, INDIA.			
Date of Registration	07/03/2008		
Title	Inverter		
Priority NA			
Design Number	217593		
Class	14-03		
1)Nokia Corporation Keilalahdentie 4 Fin-02150 Espoo Finland			
Date of Registration	07/08/2008		
Title	Handset		
Priority			
Priority Number	Date	Country	
29/303, 488	11/02/2008	U.S.A.	

Design Number	217595	
Class	14-03	
1)Nokia Corporation Keilalahdentie 4 Fin-02150 Espoo Finland		
Date of Registration	07/08/2008	
Title	Handset	
Priority		
Priority Number	Date	Country
29/303, 529	11/02/2008	U.S.A.





Design Number	219820	
Class	11-01	
1)Preciosa s.a. Opletalova 3197, 466 67 Jablonec nad Nisou, Czech Republic		
Date of Registration	21/11/2008	
Title	Gemstone	
Priority		
Priority Number	Date	Country
EM 000938642-0029	22/05/2008	OHIM



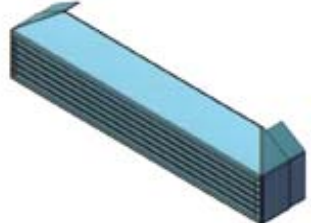

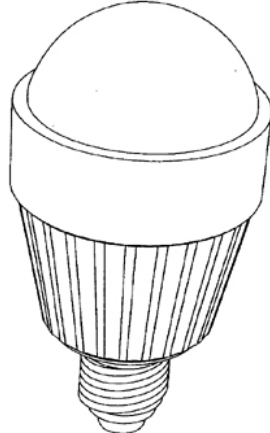
Design Number	219944	
Class	26-99	
1)Crompton Greaves Limited., 6th Floor, CG House, Dr Annie Besant Road, Worli, Mumbai-400 030, Maharashtra, India.		
Date of Registration	02/12/2008	
Title	AN END CAP OF A LUMINAIRE	
Priority NA		



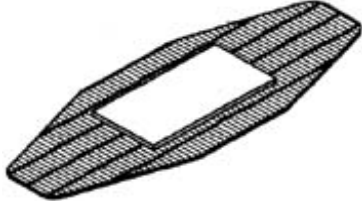

Design Number	220018	
Class	26-04	
1)Panasonic Corporation 1006, Oaza Kadoma, Kadoma-shi, Osaka 571-8501, Japan		
Date of Registration	05/12/2008	
Title	Diode Lamp	
Priority NA		
Design Number	220163	
Class	07-05	
1)Crompton Greaves Limited., 6th Floor, C.G. House, Dr Annie Besant Road, Worli, Mumbai-400 030, Maharashtra, India.		
Date of Registration	12/12/2008	
Title	"IRON"	
Priority NA		
Design Number	220168	
Class	13-03	
1)Larsen & Toubro Limited L & T House, Ballard Estate, Mumbai-400 001, Maharashtra, India.		
Date of Registration	12/12/2008	
Title	Split Meter Display Unit	
Priority NA		



Design Number	207389		
Class	24-04		
1)3M Innovative Properties Company 3M Center, Saint Paul, Minnesota 55133-3427, USA			
Date of Registration	12/12/2006		
Title	Bandage		
Priority			
Priority Number	Date	Country	
29/261,302	12/06/2006	U.S.A.	

Design Number	212820		
Class	14-99		
1)Innovative Office Products, Inc., 100 Keubler Road, Easton, Pennsylvania 18040, USA			
Date of Registration	08/10/2007		
Title	Stand		
Priority			
Priority Number	Date	Country	
29/286,166	25/04/2007	U.S.A.	

Design Number	212930		
Class	23-03		
1)Indian Oil Corporation Limited., Research & Development Centre, Sector-13, Faridabad-121 007, Haryana, India.			
Date of Registration	12/10/2007		
Title	"Room Heater based on Kerosene"		
Priority NA			

Design Number	220799		
Class	24-04		
1)Mcneil PPC, INC., 199 Grandview Road, Skillman, Nj 08558, Usa.			
Date of Registration	15/01/2009		
Title	Sanitary Napkin		
Priority			
Priority Number	Date	Country	
29/322157	30/07/2008	U.S.A.	
Design Number	220861		
Class	05-05		
1)Charming Apparels (P) Ltd., 402-405, 1st Floor, Main Road, Chandni Chowk, Delhi-110 006, India.			
Date of Registration	20/01/2009		
Title	Textile Fabric		
Priority NA			
Design Number	220973		
Class	07-04		
1)PYRAMID PLASTICS., B-30, ROYAL INDUSTRIAL ESTATE, 3RD FLOOR, NAIGAUM "X" ROAD, WADALA, MUMBAI-400 031, MAHARASHTRA, INDIA.			
Date of Registration	29/01/2009		
Title	Strainer		
Priority NA			

Design Number	221002		
Class	12-08		
1)Toyota Jidosha Kabushiki Kaisha 1, Toyota-Cho, Toyota-shi, Aichi-ken 471-8571, Japan			
Date of Registration	30/01/2009		
Title	Automobile		
Priority			
Priority Number	Date	Country	
2008-024919	29/09/2008	Japan	
Design Number	216067		
Class	13-03		
1)Larsen And Toubro Limited., L & T House, Ballard Estate, Mumbai-400 001, Maharashtra, India.			
Date of Registration	28/04/2008		
Title	Changeover Switch-Disconnecter		
Priority NA			
Design Number	216068		
Class	13-03		
1)Larsen And Toubro Limited., L & T House, Ballard Estate, Mumbai-400 001, Maharashtra, India.			
Date of Registration	28/04/2008		
Title	Changeover Switch-Disconnecter		
Priority NA			

Design Number	218697		
Class	10-06		
1)Carl F India Private Limited Oberoi Garden Estate, "A" Wing, 3rd floor, Chandivali Farms Road, Andheri-East, Mumbai-400072, Maharashtra, India			
Date of Registration	23/09/2008		
Title	Signal (for indicating location)		
Priority NA			
Design Number	221073		
Class	12-16		
1)Doga S.A., Carretera N-II, Km. 583, Abrera-08630, Barcelona, Spain.			
Date of Registration	04/02/2009		
Title	Windscreen Wipers		
Priority			
Priority Number	Date	Country	
000982871-0001	05/08/2008	EUROPEAN UNION	
Design Number	221078		
Class	07-05		
1)Koninklijke Philips Electronics N.V. Groenewoudseweg 1, 5621 Ba Eindhoven, The Netherlands.			
Date of Registration	05/02/2009		
Title	Electric Steam Iron		
Priority			
Priority Number	Date	Country	
000983515	07/08/2008	OHIM	

Design Number	221079		
Class	26-03		
1)GE India Industrial Pvt. Ltd., Plot No. 42/1, & 45/14, Electronic City Phase II, Bangalore-560100, Karnataka, India.			
Date of Registration	05/02/2009		
Title	Integral Flood Light		
Priority NA			
Design Number	221312		
Class	26-06		
1)Honda Motor Co., Ltd., 1-1, Minami-Aoyama 2-Chome, Minato-Ku, Tokyo, Japan.			
Date of Registration	19/02/2009		
Title	Lamp Case For Motorcycle		
Priority			
Priority Number	Date	Country	
2008-021391	21/08/2008	Japan	
Design Number	221338		
Class	09-03		
1)Leister Process Technologies., Galileostrasse 10, Ch-6056 Kaegiswil, Switzerland.			
Date of Registration	20/02/2009		
Title	Tool Box		
Priority			
Priority Number	Date	Country	
001075113	26/01/2009	OHIM	

Design Number	221350	
Class	12-16	
1)Gm Global Technology Operations, Inc., 300 Renaissance Center, Detroit, Michigan 48265-3000, Usa.		
Date of Registration	23/02/2009	
Title	Front Bumper of Car	
Priority		
Priority Number	Date	Country
30-2008-0050586	25/11/2008	Korea(South)



Design Number	218402	
Class	06-13	
1)Rosebys Interiors India Limited A-17, Sector 58, Noida-201303, Uttar Pradesh		
Date of Registration	05/09/2008	
Title	Bedsheet	
Priority NA		



Design Number	218423	
Class	08-06	
1)Southco, Inc. 210N, Brinton Lake Road, P.O. Box 0116, Concordville, PA 19331-0116, US		
Date of Registration	05/09/2008	
Title	Paddle Actuator	
Priority		
Priority Number	Date	Country
29/304,924	10/03/2008	U.S.A.

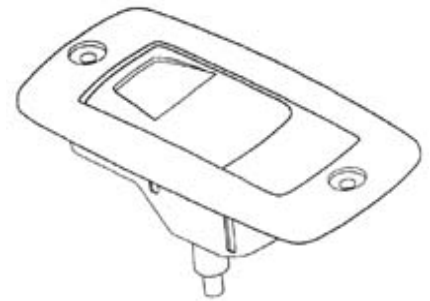

Design Number	218528	
Class	12-09	
1)Kubota Corporation 2-47, Shikitsuhashi, 1-Chome, Naniwa-Ku, Osaka-Shi Osaka 5568601, Japan		
Date of Registration	11/09/2008	
Title	Tractor	
Priority		
Priority Number	Date	Country
2008-018527	17/07/2008	Japan



Design Number	221479	
Class	23-02	
1)Hansgrohe Ag., Austr. 5-9, D-77761 Schiltach, Germany.		
Date of Registration	02/03/2009	
Title	Shower	
Priority		
Priority Number	Date	Country
001007330-0009	23/09/2008	OHIM







Design Number	221482	
Class	12-08	
1)Bayerische Motoren Werke Aktiengesellschaft. Petuelring 130, 80809, Munich, Germany.		
Date of Registration	02/03/2009	
Title	Motor Vehicle	
Priority		
Priority Number	Date	Country
DE 402008004270.0	04/09/2008	Germany

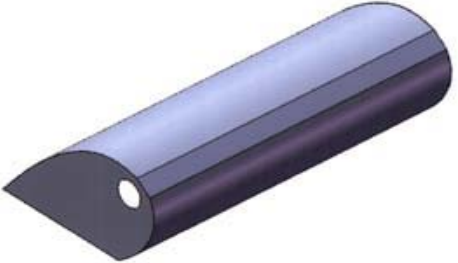

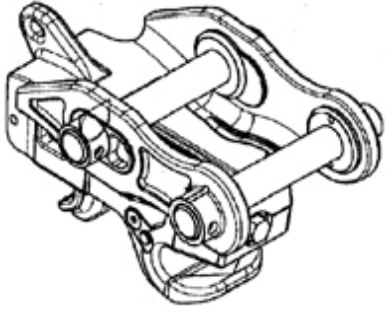

Design Number	221498		
Class	24-03		
1)Ulrich Gmbh & Co. Kg., Buchbrunnenweg 12 89081, Ulm, Germany.			
Date of Registration	03/03/2009		
Title	Medical Implant		
Priority			
Priority Number	Date	Country	
465 061 601	22/10/2008	EUROPEAN UNION	

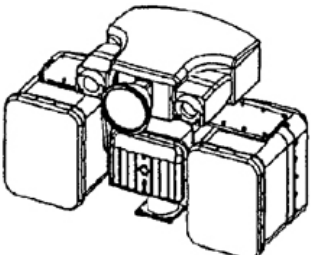
Design Number	216259		
Class	26-05		
1)Crompton Greaves Limited, 6th Floor, CG House, Dr Annie Besant Road, Worli, Mumbai 400030, Maharashtra, India			
Date of Registration	09/05/2008		
Title	Light Reflector		
Priority NA			

Design Number	216325		
Class	12-16		
1)Jb Attachments Limited., C/-Bdo Spicers, Level 2 Bdo House, 116 Harris Road, East Tamaki, Auckland, New Zealand.			
Date of Registration	15/05/2008		
Title	Coupler		
Priority			
Priority Number	Date	Country	
NZ410042	16/11/2007	New Zealand	

Design Number	216360		
Class	28-03		
1)Orchid Hardware (P) Ltd., 143/A Ii Aji, Gidc, Rajkot-360 003, Gujarat, India.			
Date of Registration	16/05/2008		
Title	Dish for Soap		
Priority NA			
Design Number	219250		
Class	10-05		
1)Moog Inc., Jamison Road, East Aurora, New York 14052, U.S.A.			
Date of Registration	16/10/2008		
Title	Two Speaker Remote Acoustic Hailing Device		
Priority			
Priority Number	Date	Country	
29/307, 441	21/04/2008	U.S.A.	
Design Number	219253		
Class	06-05		
1)Veneta Cucine S.P.A. Via Paris bordone, 84, 31056 Roncade, Frazione BIANCADE (Prov. Of Treviso), Italy			
Date of Registration	16/10/2008		
Title	Kitchen Furniture		
Priority			
Priority Number	Date	Country	
VE2008O000008	16/04/2008	Italy	

Design Number	219310		
Class	10-06		
1)Werma Signaltechnik GmbH + Co, Kg., 78604 Rietheim-Weiheim, Germany			
Date of Registration	17/10/2008		
Title	Signal Apparatus		
Priority			
Priority Number	Date	Country	
40 2008 001 918.0	17/04/2008	Germany	
Design Number			
219344			
Class	23-02		
1)Keramik Holding AG Laufen Wahlenstrasse 46, 4242 Laufen, Switzerland			
Date of Registration	20/10/2008		
Title	Toilet With Tank		
Priority			
Priority Number	Date	Country	
2008-00376	18/04/2008	Switzerland	
Design Number			
219345			
Class	23-02		
1)Keramik Holding AG Laufen Wahlenstrasse 46, 4242 Laufen, Switzerland			
Date of Registration	20/10/2008		
Title	Bath Tub		
Priority			
Priority Number	Date	Country	
2008-00376	18/04/2008	Switzerland	

Design Number	219346		
Class	23-02		
1)Keramik Holding AG Laufen Wahlenstrasse 46, 4242 Laufen, Switzerland			
Date of Registration	20/10/2008		
Title	Toilet		
Priority			
Priority Number	Date	Country	
2008-00376	18/04/2008	Switzerland	
Design Number	219401		
Class	23-04		
1)ebm-papst Mulfingen GmbH & Co. Kg, Bachmuhle 2, 74673 Mulfingen, Germany			
Date of Registration	22/10/2008		
Title	Fan		
Priority			
Priority Number	Date	Country	
000928247	02/05/2008	OHIM	
Design Number	221781		
Class	23-02		
1)Hansgrohe AG Austr. 5-9, D-77761 Schiltach, Germany			
Date of Registration	19/03/2009		
Title	Head Shower		
Priority			
Priority Number	Date	Country	
001011415-0014	26/09/2008	OHIM	

Design Number	221782	
Class	23-02	
1)Hansgrohe AG., Austr. 5-9, D-77761 Schiltach, Germany.		
Date of Registration	19/03/2009	
Title	Hand Shower	
Priority		
Priority Number	Date	Country
001011415-0020	26/09/2008	OHIM





Design Number	222000	
Class	12-15	
1)Continental Aktiengesellschaft., Vahrenwalder Strasse, D-30165 Hannover, Germany.		
Date of Registration	27/03/2009	
Title	Tyre	
Priority		
Priority Number	Date	Country
1049761-0001	03/12/2008	EUROPEAN UNION



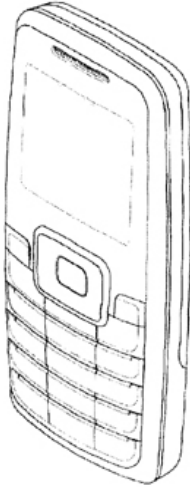
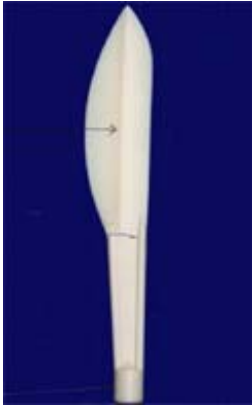

Design Number	222081	
Class	12-16	
1)Tata Motors Limited., Bombay House, 24 Homi Mody Street, Hutatma Chowk, Mumbai-400 001, Maharashtra, India.		
Date of Registration	30/03/2009	
Title	Twin Exhaust Pipe	
Priority NA		



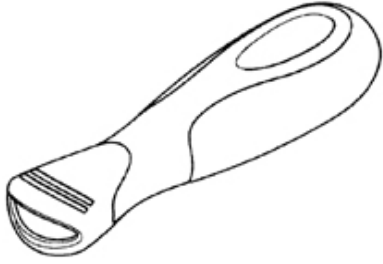



Design Number	214476	
Class	14-03	
1)Sumsung Electronics Co. Ltd., 416, Maetan-3dong, Yeongtong-Gu, Suwon-City, Gyeonggi-Do, Korea.		
Date of Registration	29/01/2008	
Title	Cellular Phone	
Priority NA		
Design Number	214653	
Class	07-03	
1)IDRIS ADAM BADHRA., 3, RAMJI PATEL COMPOUND, BEHIND BOMBAY HARDWARE, PATHANWADI ROAD, MALAD (E), MUMBAI-400 097, MAHARASHTRA, INDIA. 2)Idris Adam Badhra.,		
Date of Registration	12/02/2008	
Title	Spoon	
Priority NA		
Design Number	217260	
Class	11-02	
1)M/S. VIBGYOR OVERSEAS 2/60, MAKHAN LAL PLAZA, PUTURIA MAHAL, YAMUNA KINARA ROAD, AGRA, UP, INDIA. 2)Shri Atul Kant Gupta, Shri Ajay Agarwal, Smt. Rachna Agrawal And Smt. Madhulika Gupta.,		
Date of Registration	22/07/2008	
Title	"Decorative Article"	
Priority NA		

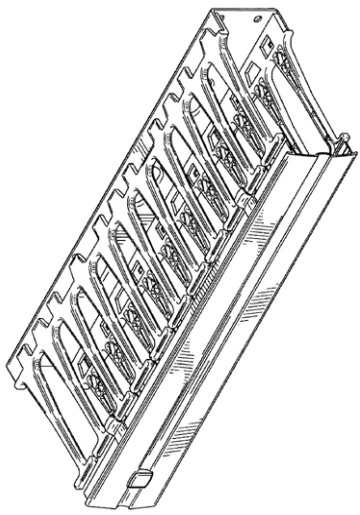

Design Number	219424		
Class	08-06		
1)Kapman Ab C/o SNA Europe (Industries) AB, 81181 Sandviken, Sweden			
Date of Registration	23/10/2008		
Title	File Handle		
Priority			
Priority Number	Date	Country	
1014112	03/10/2008	OHIM	

Design Number	219661		
Class	06-13		
1)Eicher Goodearth Private Limited 12 Commercial Complex, Greater Kailash, Part-II, (Masjid Moth), New Delhi-110048, India			
Date of Registration	12/11/2008		
Title	Cushion Cover		
Priority NA			

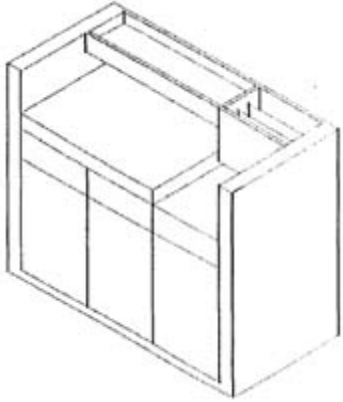
Design Number	219662		
Class	06-13		
1)Eicher Goodearth Private Limited 12 Commercial Complex, Greater Kailash, Part-II, (Masjid Moth), New Delhi-110048, India			
Date of Registration	12/11/2008		
Title	Cushion Cover		
Priority NA			

Design Number	222205		
Class	08-99		
1)CROMPTON GREAVES LIMITED., 6TH FLOOR, CG HOUSE, DR ANNIE BESANT ROAD, WORLI, MUMBAI-400 030, MAHARASHTRA, INDIA.			
Date of Registration	31/03/2009		
Title	CEILING FAN ASSEMBLY FIXTURE		
Priority NA			
Design Number	216920		
Class	05-05		
1)Biba Apparels Pvt. Ltd., 45-54, ;Whitehall, Kemp's Corner, 143, A.K.Marg, Mumbai-400 036. Maharashtra, India.			
Date of Registration	30/06/2008		
Title	Textile Fabric		
Priority NA			
Design Number	216982		
Class	13-03		
1)Chatsworth Products, Inc., 31425 Agoura Road Westlake Village, CA 91361-4614, United States of America			
Date of Registration	02/07/2008		
Title	Raceway For Cable Management		
Priority			
Priority Number	Date	Country	
29/302, 291	14/01/2008	U.S.A.	

Design Number	217041		
Class	20-02		
1)Swatch AG (Swatch SA) (Swatch Ltd), Jakob-Stampfli-Strasse 94, Beil/Bienne, Switzerland.			
Date of Registration	08/07/2008		
Title	Display		
Priority			
Priority Number	Date	Country	
DM/069 638	08/01/2008	WIPO	
Design Number	220378		
Class	17-99		
1)Rajanya 1698, Arya Samaj Road, Karol Bagh, New Delhi-110005			
Date of Registration	22/12/2008		
Title	Speaker Cabinet		
Priority NA			
Design Number	220382		
Class	09-03		
1)Manoj Kumar Goel Awass Vikas Kichha, Udham Singh Nagar, Uttarachal-263148			
Date of Registration	22/12/2008		
Title	Bottle		
Priority NA			

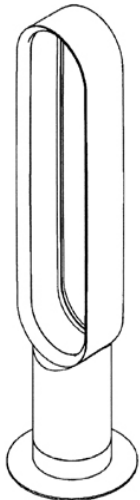
Design Number	220383		
Class	09-03		
1)Manoj Kumar Goel Awas Vikas Kichha, Udham Singh Nagar, Uttarachal-263148			
Date of Registration	22/12/2008		
Title	"CONTAINER"		
Priority NA			
Design Number	220446		
Class	12-08		
1)Toyota Jidosha Kabushiki Kaisha 1, Toyota-Cho, Toyota-shi, Aichi-ken 471-8571, Japan			
Date of Registration	24/12/2008		
Title	"MOTOR CAR"		
Priority NA			
Design Number	220505		
Class	23-04		
1)Dyson Limited Tetbury Hill, Malmesbury, Wiltshire SN 16 0RP, the United Kingdom			
Date of Registration	26/12/2008		
Title	Fan		
Priority			
Priority Number	Date	Country	
GB 4008392	19/07/2008	U.K.	