

CONTINUED FROM PART- 1

INTRODUCTION

In view of the recent amendment made in the Designs (Amendment) Rules, 2008 with effect from 17/06/2008, Publication of the matter relating to Designs is being published in the Official Journal of The Patent Office. This Journal is being published on weekly basis on every Friday covering the various proceedings on Designs as required according to the provisions of under Rule 22, 25, 27 and 39 of the Design (Amendment) Rules, 2008. All the enquiries on this Official Journal and other information as required by the public should be addressed to the Controller General of Patents, Designs & Trade Marks. Suggestions and comments are requested from all quarters so that the content can be enriched.



CANCELLATION PROCEEDINGS
under Section 19 of the Designs Act, 2000



“The Ld. Asstt. Controller of Patents & Designs passed an order on 25/8/2010 to dismiss the petition filed by M/s Lucky Exports, a partnership firm having its registered office at C-192, Phase VI, Focal Point, Ludhiana-141010, Punjab on 11.05.2007 for cancellation of registration of the registered Design No. 201728 dated 10/10/2005 under Class 12-11 for the article ‘Coaster Brake Hub’ in the name of Sh. Dalip Kumar and Sh. Bharat Bhusan both partners of International Cycle Gears, a partnership firm of B-50, Phase VII, Focal Point, Ludhiana, Punjab, Indian”

“The Ld. Asstt. Controller of Patents & Designs passed an order on 25/8/2010 to dismiss the petition filed by M/s Lucky Exports, a partnership firm having its registered office at C-192, Phase VI, Focal Point, Ludhiana-141010, Punjab on 27.9.2007 for cancellation of registration of the registered Design No. 202108 dated 11/11/2005 under Class 12-11 for the article ‘Coaster Brake Sub Assembly’ in the name of Sh. Dalip Kumar and Sh. Bharat Bhusan both partners of M/s. International Cycle Gears, a partnership firm of B-50, Phase VII, Focal Point, Ludhiana, State of Punjab, Indian”

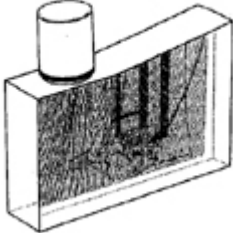

REGISTRATION OF DESIGNS



The following designs have been registered. They are now open for public inspection. In the following each entry the Date of Registration is shown. The Priority Number, Priority Date and Priority Country are also shown

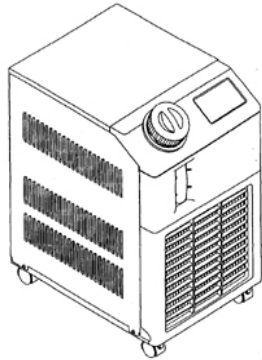
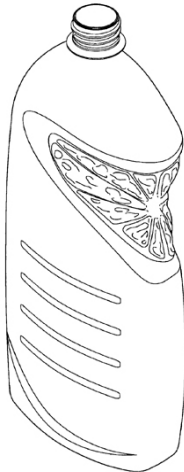

Design Number	211896		
Class	26-05		
1)Flos S.P.A. Via A. Faini 2, 25073 Bovezzo (Brescia), Italy			
Date of Registration	17/08/2007		
Title	Wall Lamp		
Priority			
Priority Number	Date	Country	
000698774-0003	30/03/2007	OHIM	
Design Number	211900		
Class	11-01		
1)Punita Trrikha S-69, Greater Kailash, Part-1, New Delhi-110048, India			
Date of Registration	17/08/2007		
Title	Anklet		
Priority NA			
Design Number	215100		
Class	09-01		
1)Kenzo 1 Rue Du Pont Neuf, 75001 Paris, France			
Date of Registration	04/03/2008		
Title	Flask For Perfumery Products		
Priority			
Priority Number	Date	Country	
07 3990	05/09/2007	France	



Design Number	215101		
Class	12-11		
1)Honda Motor Co. Ltd. 1-1, Minamiaoyama 2-Chome, Minato-Ku, Tokyo, Japan			
Date of Registration	04/03/2008		
Title	Motorcycle		
Priority			
Priority Number	Date	Country	
2007-024212	05/09/2007	Japan	
Design Number	215106		
Class	09-01		
1)Pearl Polymers Limited., B-59, Greater Kailash, Part-1, New Delhi-110 048, India.			
Date of Registration	04/03/2008		
Title	Bottle		
Priority NA			
Design Number	215145		
Class	09-01		
1)K.S.Oils Limited., Jivaji Ganj, Morena (M.P) - 476 001, India. Also At: 806, New Delhi House, 27, Barakhambha Road, New Delhi-110 001, India.			
Date of Registration	06/03/2008		
Title	Bottle		
Priority NA			

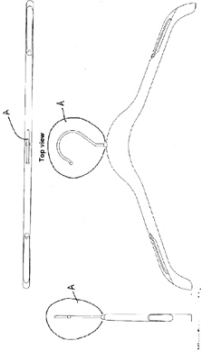

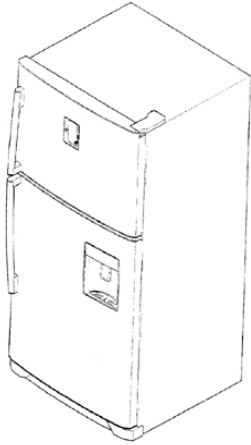
Design Number	215146				
Class	09-02				
1)K.S.Oils Limited., Jivaji Ganj, Morena (M.P) - 476 001, India. Also At 806, New Delhi House, 27, Barakhambha Road, New Delhi-110 001, India.					
Date of Registration	06/03/2008				
Title	Container				
Priority NA					
					
			Design Number	219716	
			Class	05-05	
			1)Charming Apparels (P) Ltd., 402-405, 1st Floor, Main Road, Chandni Chowk, Delhi-110 006, India		
			Date of Registration	17/11/2008	
			Title	Textile Fabric	
Priority NA					
					
			Design Number	219879	
			Class	12-16	
			1)Donaldson Company, Inc., 1400 West 94th Street, P.O. Box 1299, Minneapolis, Minnesota 55440-1299, United States of America		
			Date of Registration	26/11/2008	
			Title	Filter Cartridge	
Priority					
Priority Number	Date	Country			
29/308, 207	02/06/2008	U.S.A.			
					

Design Number	219902		
Class	23-03		
1)SMC Corporation 14-1, Sotokanda 4-chome, Chiyoda-ku, Tokyo, Japan			
Date of Registration	28/11/2008		
Title	Constant Temperature Liquid Circulating Instrument		
Priority			
Priority Number	Date	Country	
2008-027259	23/10/2008	Japan	
Design Number	220135		
Class	09-01		
1)Hindustan Unilever Limited., Hindustan Lever House 165-166 Backbay Reclamation, Mumbai 400020, State of Maharashtra, India			
Date of Registration	10/12/2008		
Title	Bottle		
Priority			
Priority Number	Date	Country	
4007896	11/06/2008	U.K.	
Design Number	206859		
Class	05-05		
1)Riba Textiles Limited DD-14, Nehru Enclave, New Delhi-110019 India			
Date of Registration	25/09/2006		
Title	Textile Fabrics(Towels)		
Priority NA			

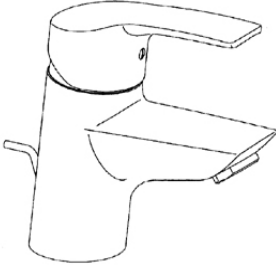

Design Number	213287		
Class	04-02		
1)JATIN VASANT THAKKAR., L-3/4, EDEN HALL, DR. ANNIE BESANT ROAD, WORLI, MUMBAI-400 018, MAHARASHTRA, INDIA.			
Date of Registration	05/11/2007		
Title	Tooth Brush		
Priority NA			
Design Number	216015		
Class	24-01		
1)International Patents Inc., La Rosiere (Registered Agents and Trustees) Limited, Maison La Rosiere, Victoria, Mahe, The Seychelles.			
Date of Registration	24/04/2008		
Title	Endotracheal Tube		
Priority			
Priority Number	Date	Country	
000818539	25/10/2007	OHIM	
Design Number	216021		
Class	06-08		
1)Mainetti (Uk) Limited., Annfield Estate, Oxnam Road, Jedburgh, Roxburghshire, Scotland, Td8 6nn, Uk.			
Date of Registration	25/04/2008		
Title	Garment Hanger		
Priority			
Priority Number	Date	Country	
4005072	26/10/2007	U.K.	

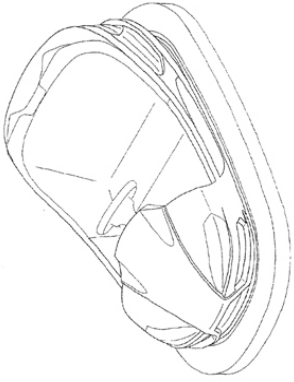
Design Number	216023	
Class	15-07	
1)Samsung Electronics Co. Ltd., 416, Maetan-Dong, Yeongtong-Gu, Suwon-Si, Gyeonggi-Do, Korea.		
Date of Registration	25/04/2008	
Title	Refrigerator	
Priority NA		
Design Number	216024	
Class	15-05	
1)Samsung Electronics Co., Ltd., 416, Maetan-dong, Yeongtong-Gu, Suwon-Si, Gyeonggi-Do, Republic of Korea.		
Date of Registration	25/04/2008	
Title	DRUM TYPE WASHING MACHINE	
Priority NA		
Design Number	216032	
Class	14-03	
1)Hutchison Harbour Ring Enterprises Limited., P.O.Box 71, Craigmuir Chambers, Road Town, Tortola, British Virgin Islands.		
Date of Registration	25/04/2008	
Title	I. Voicepro Bluetooth Headset	
Priority NA		

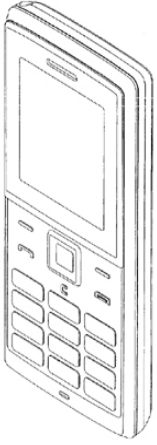
Design Number	216035		
Class	23-01		
1)Hansa Metallwerke Ag., Sigmaringer Str. 107, D-70567 Stuttgart, Germany.			
Date of Registration	25/04/2008		
Title	Sanitary Fitting		
Priority			
Priority Number	Date	Country	
000822119-0001	08/11/2007	EUROPEAN UNION	
Design Number	216036		
Class	23-01		
1)Hansa Metallwerke AG Sigmaringer STR. 107, D-70567, Stuttgart, Germany			
Date of Registration	25/04/2008		
Title	Sanitary Fitting		
Priority			
Priority Number	Date	Country	
000822119-0003	08/11/2007	EUROPEAN UNION	
Design Number	216128		
Class	07-03		
1)Vasant V. Oza., & Haresh V. Oza., Aji G.I.D.C., C-1. B-238/2 + A/2 Road-P Nr, Jaydeep Industries Rajkot 360003, Gujarat, India.			
Date of Registration	30/04/2008		
Title	Kniff		
Priority NA			

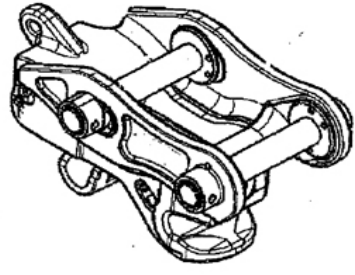
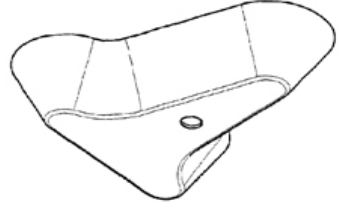
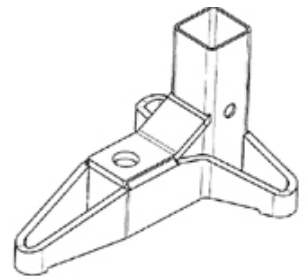

Design Number	216196		
Class	12-08		
1)Bertazzon 3b S.R.L., Via Trevigiana, 178-31020 Sernaglia (Tv), Italy.			
Date of Registration	05/05/2008		
Title	Bumper Car		
Priority			
Priority Number	Date	Country	
000821764	07/11/2007	OHIM	
Design Number	216216		
Class	15-03		
1)Dasmesh Mechanical Works., Nabha Malerkotla Road, Amargarh, Distt. Sangrur-148022, Punjab, India.			
Date of Registration	07/05/2008		
Title	Roto Seeder		
Priority NA			
Design Number	216267		
Class	14-03		
1)Samsung Electronics Co. Ltd., 416, Maetan 3-Dong, Paldal-Gu, Suwon-City, Kyunggi-Do, Korea.			
Date of Registration	09/05/2008		
Title	Portable telephone		
Priority NA			



Design Number	216327		
Class	12-16		
1)Jb Attachments Limited., C/-Bdo Spicers, Level 2 Bdo House, 116 Harris Road, East Tamaki, Auckland, New Zealand.			
Date of Registration	15/05/2008		
Title	Coupler		
Priority			
Priority Number	Date	Country	
Nz410043	16/11/2007	New Zealand	
Design Number	216376		
Class	25-01		
1)Combisafe International Ab., Storsjostraket 15, 831 34 Ostersund, Sweden.			
Date of Registration	19/05/2008		
Title	Protection Devices		
Priority			
Priority Number	Date	Country	
000834833	30/11/2007	OHIM	
Design Number	216377		
Class	25-01		
1)Combisafe International Ab., Storsjostraket 15, 831 34 Ostersund, Sweden.			
Date of Registration	19/05/2008		
Title	Post Supports		
Priority			
Priority Number	Date	Country	
000834825	30/11/2007	OHIM	

Design Number	220162		
Class	23-04		
1)Crompton Greaves Limited., 6th Floor, C.G. House, Dr. Annie Besant Road, Worli, Mumbai-400 030, Maharashtra, India.			
Date of Registration	12/12/2008		
Title	Table Fan		
Priority NA			
Design Number	211170		
Class	14-03		
1)NOKIA CORPORATION KEILALAHDENTIE 4, FIN-02150 ESPOO, FINLAND.			
Date of Registration	11/07/2007		
Title	Handset		
Priority			
Priority Number	Date	Country	
M20070014	19/01/2007	Finland	
Design Number	213842		
Class	15-09		
1)M/S. Hard Grip (India)., E-247, Phase-Iv A, Focal Point, Ludhiana-141010, Punjab, India.			
Date of Registration	20/12/2007		
Title	Cold Heading Machine		
Priority NA			

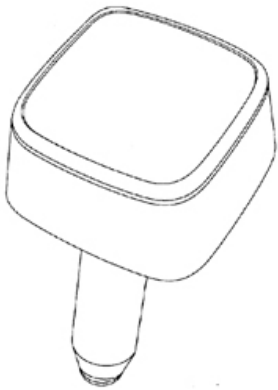
Design Number	218339		
Class	13-01		
1)Sew-Eurodrive GmbH & Co. KG Ernst-Blickle-Straße 42, 76646 Bruchsal, Germany			
Date of Registration	02/09/2008		
Title	Electric Motor		
Priority			
Priority Number	Date	Country	
40 2008 001 260.07	04/03/2008	Germany	
Design Number	220894		
Class	28-01		
1)Aurobindo Pharma Ltd., Plot No.2, Maitrivihar, Ameerpet, Hyderabad-500038, Andhra Pradesh, India			
Date of Registration	22/01/2009		
Title	Blister Pack		
Priority NA			
Design Number	221040		
Class	23-02		
1)HSIL Limited., Bahadurgarh-124507, Distt- Jhajjar, Haryana, India.			
Date of Registration	02/02/2009		
Title	WALL MOUNTED EUROPEAN WATER CLOSET		
Priority NA			

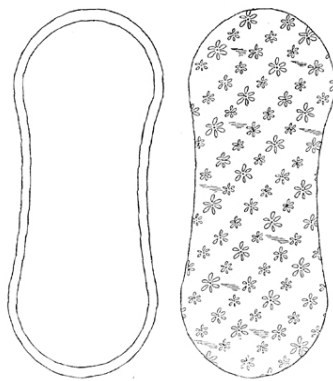
Design Number	216383		
Class	11-01		
1)Lili Diamonds., The Diamond Exchange-Maccabi Building, 1 Jabotinsky Street, Ramat Gan 52520, Israel.			
Date of Registration	21/05/2008		
Title	Gemstone		
Priority			
Priority Number	Date	Country	
IL 45121	02/12/2007	Ireland	
Design Number	216484		
Class	09-01		
1)Yugha Herbal Care Pvt. Ltd., 1112-A, Kirti Sikhar Building, 11th Floor, Distt. Centre, Janak Puri, New Delhi-110058, India.			
Date of Registration	29/05/2008		
Title	Bottle		
Priority NA			
Design Number	216554		
Class	24-02		
1)Leow Ngah Chai., No. 7, Jalan Kip 3, Taman Perindustrian Kip, 52200 Kuala Lumpur Malaysia.,			
Date of Registration	05/06/2008		
Title	Nasal Cannula		
Priority			
Priority Number	Date	Country	
07-01917-0101	31/12/2007	Malaysia	

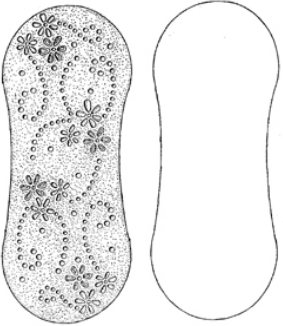

Design Number	216835		
Class	13-02		
1)Nokia Corporation, Keilalahdentie 4, Espoo, Fin-02150, Finland.			
Date of Registration	20/06/2008		
Title	Charger		
Priority NA			
Design Number	219404		
Class	23-04		
1)ebm-papst Mulfingen GmbH & Co. KG., Bachmuhle 2, 74673 Mulfingen, Germany			
Date of Registration	22/10/2008		
Title	Fan		
Priority			
Priority Number	Date	Country	
000928247	02/05/2008	OHIM	
Design Number	219558		
Class	05-06		
1)McNeil PPC, Inc., 199 Grandview Road, Skillman, Nj 08558, USA.			
Date of Registration	05/11/2008		
Title	Releasable Backsheet Material For Absorbent Article		
Priority			
Priority Number	Date	Country	
29/317, 679	05/05/2008	U.S.A.	

Design Number	219559		
Class	24-04		
1)McNeil PPC, Inc., 199 Grandview Road, Skillman, Nj 08558, USA.			
Date of Registration	05/11/2008		
Title	Embossed Absorbent Article		
Priority			
Priority Number	Date	Country	
29/317, 678	05/05/2008	U.S.A.	
Design Number	219666		
Class	06-13		
1)Eicher Goodearth Private Limited. 12 Commercial Complex, Greater Kailash, Part-II, (Masjid Moth), New Delhi-110048, India			
Date of Registration	12/11/2008		
Title	Cushion Cover		
Priority NA			
Design Number	221584		
Class	26-02		
1)Sree Lakshmi Enterprise., 1/1g, Radha Mohan Dey Lane, Kolkata-700 036, W.B., India.			
Date of Registration	09/03/2009		
Title	Led Table Torch		
Priority NA			

Design Number	221654		
Class	09-01		
1)Saverglass., 3, Rue De La Gare-60960, Feuquieres, France.			
Date of Registration	13/03/2009		
Title	Bottle		
Priority			
Priority Number	Date	Country	
001028625-0001	27/10/2008	OHIM	
Design Number	221659		
Class	09-01		
1)Saverglass., 3, Rue De La Gare-60960, Feuquieres, France.			
Date of Registration	13/03/2009		
Title	Bottle		
Priority			
Priority Number	Date	Country	
001028625-0009	27/10/2008	OHIM	
Design Number	221698		
Class	08-07		
1)Nic Products, Inc., 3100 Oak Road, Suite 210, Walnut Creek, Ca 94597, USA.			
Date of Registration	16/03/2009		
Title	Security Lock		
Priority			
Priority Number	Date	Country	
29/324,582	16/09/2008	U.S.A.	

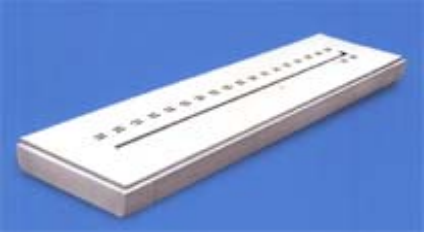
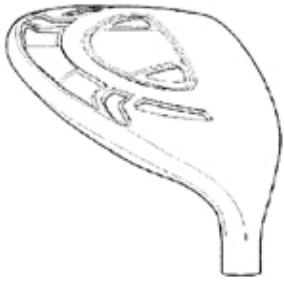
Design Number	221701		
Class	08-03		
1)Tata Motors Limited., Bombay House, 24 Homi Mody Street, Hutatma Chowk, Mumbai-400 001, Maharashtra, India.			
Date of Registration	16/03/2009		
Title	Polycrystalline Diamond (Pcd) Multi Edgemetal Cutting Insert		
Priority NA			
Design Number	221732		
Class	23-02		
1)Hansgrohe Ag., Auestr. 5-9, D-77761 Schiltach, Germany.			
Date of Registration	17/03/2009		
Title	Brush Holder		
Priority			
Priority Number	Date	Country	
001007314-0006	23/09/2008	OHIM	
Design Number	221767		
Class	06-11		
1)William Goodacre & Sons India Pvt. Ltd., XVIII/1146 Revi Karunakaran Road, Alleppey, Kerala-688012, India.			
Date of Registration	19/03/2009		
Title	"Mat"		
Priority NA			

Design Number	221863		
Class	23-04		
1)Crompton Greaves Limited., 6th Floor, C.G. House, Dr. Annie Besant Road, Worli, Mumbai-400 030, Maharashtra, India.			
Date of Registration	23/03/2009		
Title	Ceiling Fan		
Priority NA			
Design Number	210849		
Class	26-05		
1)PHILIPS ELECTRONICS INDIA LIMITED, TECHNOPOLIS KNOWLEDGE PARK, MAHAKALI CAVES ROAD, CHAKALA, ANDHERI (E), MUMBAI-400093.			
Date of Registration	15/06/2007		
Title	"Luminaire"		
Priority NA			
Design Number	213634		
Class	21-02		
1)KARSTEN MANUFACTURING CORPORATION, 2201 WEST DESERT COVE, PHOENIX, ARIZONA 85029, USA.			
Date of Registration	04/12/2007		
Title	GOLF CLUB HEAD		
Priority			
Priority Number	Date	Country	
29/280,985	12/06/2007	U.S.A.	

Design Number	220862	
Class	05-05	
1)Charming Apparels (P) Ltd., 402-405, 1st Floor, Main Road, Chandni Chowk, Delhi-110 006, India.		
Date of Registration	20/01/2009	
Title	Textile Fabric	
Priority NA		
Design Number	209355	
Class	13-03	
1)Ajanta Limited Orpat Industrial Estate, Rajkot Highway, P.B. No. 115, Morbi-363641, State of Gujarat, India.		
Date of Registration	03/04/2007	
Title	Socket	
Priority NA		
Design Number	218107	
Class	15-02	
1)Rakesh Bhogilal Engineer B 52, Neha Apartments Juhu Tara Road Santacruz(West) Mumbai-400049 Maharashtra India		
Date of Registration	25/08/2008	
Title	Pump	
Priority NA		

Design Number	221236	
Class	05-05	
1)Charming Apparels (P) Ltd., 402-405, 1st Floor, Main Road, Chandni Chowk, Delhi-110 006, India.		
Date of Registration	16/02/2009	
Title	Textile Fabric	
Priority NA		

Design Number	221306	
Class	28-03	
1)La Mod Electronica., Rz-171a, Ravi Nagar Extn., 2, Khyala, New Delhi-18, India.		
Date of Registration	18/02/2009	
Title	Foot Massager	
Priority NA		

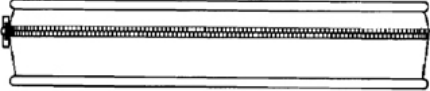
Design Number	221309	
Class	03-01	
1)Bayer Healthcare Llc., 555 White Plains Road, Tarrytown, Ny 10591, USA.		
Date of Registration	19/02/2009	
Title	Organizer Case	
Priority		
Priority Number	Date	
29/323,209	20/08/2008	U.S.A.

Design Number	221397	
Class	11-01	
1)Orogems., D-139, Defence Colony, New Delhi-110024, India.		
Date of Registration	25/02/2009	
Title	Bracelet	
Priority NA		
Design Number	221466	
Class	05-05	
1)Charming Apparels (P) Ltd., 402-405, 1st Floor, Main Road, Chandni Chowk, Delhi-110 006, India.		
Date of Registration	27/02/2009	
Title	Textile Fabric	
Priority NA		
Design Number	221467	
Class	05-05	
1)Charming Apparels (P) Ltd., 402-405, 1st Floor, Main Road, Chandni Chowk, Delhi-110 006, India.		
Date of Registration	27/02/2009	
Title	Textile Fabric	
Priority NA		