

INTRODUCTION

In view of the recent amendment made in the Designs (Amendment) Rules, 2008 with effect from 17/06/2008, Publication of the matter relating to Designs is being published in the Official Journal of The Patent Office. This Journal is being published on weekly basis on every Friday covering the various proceedings on Designs as required according to the provisions of under Rule 22, 25, 27 and 39 of the Design (Amendment) Rules, 2008. All the enquiries on this Official Journal and other information as required by the public should be addressed to the Controller General of Patents, Designs & Trade Marks. Suggestions and comments are requested from all quarters so that the content can be enriched.

COPYRIGHT PUBLICATION

SL NO	CASE NUMBERS	RENEWED ON
1.	229304	29.07.2011
2.	186232	02.08.2011
3.	186231	02.08.2011
4.	185970	11.08.2011
5.	185969	11.08.2011
6.	218409	29.07.2011
7.	229931	01.08.2011
8.	219601	01.08.2011
9.	219598	01.08.2011
10.	219596	01.08.2011
11.	219594	01.08.2011
12.	225663	18.08.2011

CANCELLATION PROCEEDINGS
under Section 19 of the Designs Act, 2000

(01)



“The Ld. Asstt. Controller of Patents & Designs passed an order on 10/8/2011 to cancel the registration of registered Design No.195622 dated 20/5/2004 under Class 06-11 titled as ‘Carpet’ in the name of S.N. Kapoor Exports, an Indian partnership firm of Khwasji ka bagh, Amer Road, Jaipur-302002, Rajasthan (India) whose partners are Surinder Nath Kapoor and Vikram Kapoor, both are Indian of above address.”

(02)



“The Ld. Asstt. Controller of Patents & Designs passed an order on 10/8/2011 to cancel the registration of registered Design No.195622 dated 19/7/2004 under Class 06-11 titled as ‘Carpet’ in the name of S.N. Kapoor Exports, an Indian partnership firm of Khwasji ka bagh, Amer Road, Jaipur-302002, Rajasthan (India) whose partners are Surinder Nath Kapoor and Vikram Kapoor, both are Indian of above address.”



REGISTRATION OF DESIGNS

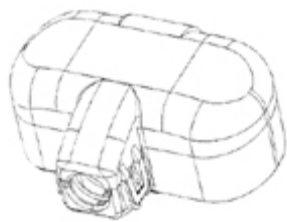

The following designs have been registered. They are now open for public inspection. In the following each entry the Date of Registration is shown. The Priority Number, Priority Date and Priority Country are also shown

Design Number	232424		
Class	02-02		
1)Thailiani Design Pvt.Ltd. 708, Pace City-2, Sector-37 Part-II, Gurgaon (Haryana),			
Date of Registration	01/11/2010		
Title	Garment		
Priority NA			
Design Number	232490		
Class	19-02		
1)Gayatri Graphics Inc., 33, Venkatramana Building, Temple Square, Car Street, Mangalore-575001, Karnataka, India			
Date of Registration	03/11/2010		
Title	Stamp Mount		
Priority NA			
Design Number	232604		
Class	26-06		
1)Honda Motor Co., Ltd., 1-1, Minami-Aoyama 2-Chome, Minato-ku, Tokyo, Japan			
Date of Registration	12/11/2010		
Title	Front Combination Lamp For Automobiles		
Priority			
Priority Number	Date	Country	
2010-011927	14/05/2010	Japan	

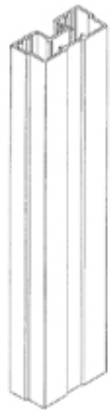
Design Number	234236	
Class	07-03	
1)Super Star Export Shiv Puri Road, Basti Danishmandan, Jhalandhar-144007, Punjab, India		
Date of Registration	03/02/2011	
Title	Spoon	
Priority NA		
Design Number	234258	
Class	09-03	
1)Hindustan Petroleum Corporation Limited Lubes Department, Hindustan Bhawan, 2nd Floor, 8 Soorji Vallabhdas Marg, Ballard Estate, Mumbai 400001, Maharashtra, India		
Date of Registration	04/02/2011	
Title	Container Lid	
Priority NA		
Design Number	234290	
Class	14-03	
1)MIC Electronics Limited A-4/II, Electronic Complex, Kushaiguda, Hyderabad-500062 Andhra Pradesh, INDIA		
Date of Registration	07/02/2011	
Title	Television	
Priority NA		

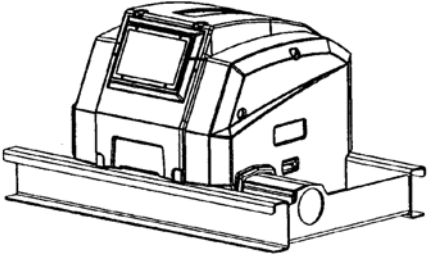
Design Number	234291		
Class	26-99		
1)MIC Electronics Limited A-4/II, Electronic Complex, Kushaiguda, HYDERABAD-500062, Andhra Pradesh, INDIA			
Date of Registration	07/02/2011		
Title	Led Lantern		
Priority NA			
Design Number	234306		
Class	09-01		
1)Bishal Distillers Limited 56, Central Road, Jadavpur, Kolkata-700032, West Bengal, India			
Date of Registration	07/02/2011		
Title	Bottle		
Priority NA			
Design Number	231615		
Class	13-03		
1)TEcumseh Europe S.A. 2 Avenue Blaise Pascal 38090 Vaulx Milieu (France)			
Date of Registration	24/09/2010		
Title	Protective casings for electrical devices.		
Priority			
Priority Number	Date	Country	
001688326	29/03/2010	OHIM	

Design Number	231628		
Class	08-09		
1)Raumplus GmbH & Co. KG, Dortmunder Strasse 35, 28199 Bremen, Germany			
Date of Registration	24/09/2010		
Title	Fittings For Doors, Windows And/Or Furniture		
Priority			
Priority Number	Date	Country	
DM/073678	26/03/2010	WIPO	
Design Number	231699		
Class	19-06		
1)Sanford, L.P., 2707 Butterfield Road, Oak Brook, Illinois 60523, U.S.A.,			
Date of Registration	30/09/2010		
Title	Writing Instrument		
Priority			
Priority Number	Date	Country	
29/359, 415	09/04/2010	U.S.A.	
Design Number	231761		
Class	15-06		
1)Staubli Lyon 31 Rue des Freres Lumiere 69680 Chassieu France			
Date of Registration	04/10/2010		
Title	Textile Jacquard Machine		
Priority			
Priority Number	Date	Country	
542490301	06/04/2010	OHIM	

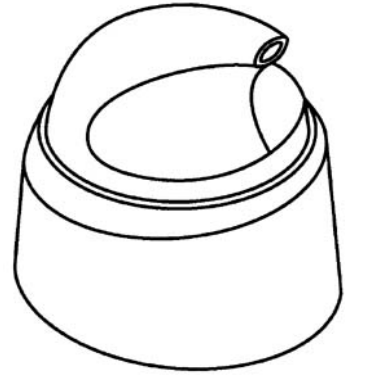

Design Number	231770		
Class	12-12		
1)Royalty Bugaboo GmbH Schmidgasse 3, 6300 Zug, Switzerland			
Date of Registration	05/10/2010		
Title	Stroller		
Priority			
Priority Number	Date	Country	
001229868	13/08/2010	OHIM	
Design Number	233519		
Class	12-16		
1)Honda Motor Co., Ltd., 1-1, Minamiaoyama 2-Chome, Minato-ku, Tokyo, Japan			
Date of Registration	24/12/2010		
Title	Front Top Cover For Motor Scooter		
Priority			
Priority Number	Date	Country	
201030225325.2	28/06/2010	China	
Design Number	233545		
Class	09-01		
1)The Procter & Gamble Company., One Procter & Gamble Plaza, Cincinnati, Ohio-45202, Usa.			
Date of Registration	24/12/2010		
Title	Dispenser		
Priority			
Priority Number	Date	Country	
29/364, 917	30/07/2010	U.S.A.	

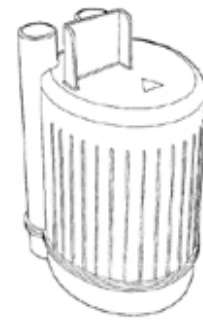

Design Number	235433	
Class	08-09	
1)Dorma India Private Limited 14, Pattulous Road, Chennai-600002, Tamil Nadu, India		
Date of Registration	22/03/2011	
Title	Metal Fitting - Wall Mounting Bracket	
Priority NA		
Design Number	235441	
Class	15-03	
1)Falcon Garden Tools Pvt. Limited., Malerkotla Road, Alamgir, Ludhuiana-141116 (Punjab) (India)		
Date of Registration	23/03/2011	
Title	Lawn Mover	
Priority NA		
Design Number	235497	
Class	12-16	
1)Tata Motors Limited Bombay House, 24 Homi Mody Street, Hutatma Chowk, Mumbai 400001, Maharashtra, India		
Date of Registration	24/03/2011	
Title	Front Bumper For Vehicle	
Priority NA		

Design Number	235536	
Class	07-06	
1)Walambia Industries, Gogate Wadi, Off: Aarey Road, Goregaon East, Mumbai-400063, Maharashtra, India		
Date of Registration	28/03/2011	
Title	Serving Tray	
Priority NA		
Design Number	235547	
Class	26-05	
1)Crompton Greaves Limited., Avantha House, 6th Floor, Dr. Annie Besant Road, Worli, Mumbai-400030, Maharashtra, India		
Date of Registration	28/03/2011	
Title	Task Light	
Priority NA		
Design Number	235556	
Class	23-04	
1)Crompton Greaves Limited., Avantha House, 6th Floor, Dr. Annie Besant Road, Worli, Mumbai-400030, Maharashtra, India		
Date of Registration	28/03/2011	
Title	Ceiling Fan	
Priority NA		

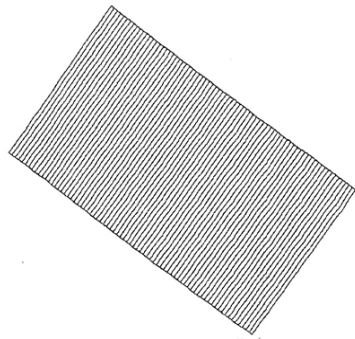

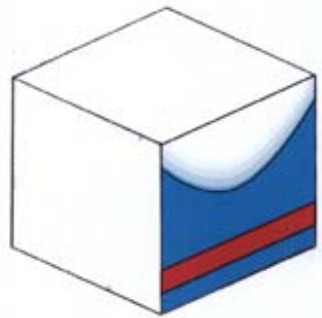
Design Number	235626	
Class	05-05	
1)Biba Apparels Pvt. Ltd., 45-54, "Whitehall", Kemps Corner, 143 A.K. Marg., Mumbai-400036, Maharashtra, India		
Date of Registration	28/03/2011	
Title	Textile Fabric	
Priority NA		
Design Number	235633	
Class	05-05	
1)Biba Apparels Pvt. Ltd., 45-54, "Whitehall", Kemps Corner, 143 A.K. Marg., Mumbai-400036, Maharashtra, India		
Date of Registration	28/03/2011	
Title	Textile Fabric	
Priority NA		
Design Number	216284	
Class	24-01	
1)Maquet Critical Care Ab., Rontgenvagen 2, Se-171 95 Solna, Sweden.		
Date of Registration	13/05/2008	
Title	Absorber Of An Anaesthetic Apparatus	
Priority		
Priority Number	Date	Country
000825658	13/11/2007	OHIM



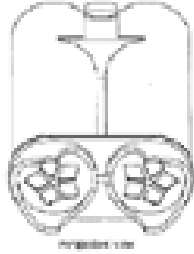
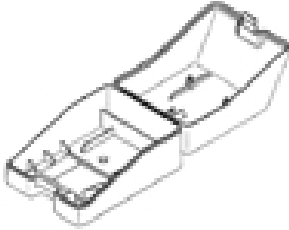

Design Number	228823		
Class	13-99		
1)Solaria Corporation 46430 Fremont Boulevard, Fremont, California 94538, United States of America			
Date of Registration	23/04/2010		
Title	Solar Panel		
Priority NA			
Design Number	228859		
Class	15-05		
1)Desiccant Rotors International Pvt. Ltd., 21C, Sector-18, Gurgaon 122015, Haryana, India			
Date of Registration	26/04/2010		
Title	Plastics Drying Cassette		
Priority NA			
Design Number	230411		
Class	09-03		
1)The Procter & Gamble Company One Procter & Gamble Plaza, Cincinnati, Ohio-45202, United States of America			
Date of Registration	23/07/2010		
Title	Packaging Box		
Priority			
Priority Number	Date	Country	
29/354, 434	25/01/2010	U.S.A.	

Design Number	230413		
Class	09-03		
1)The Procter & Gamble Company One Procter & Gamble Plaza, Cincinnati, Ohio-45202, United States of America			
Date of Registration	23/07/2010		
Title	Packaging Container		
Priority			
Priority Number	Date	Country	
29/354, 434	25/01/2010	U.S.A.	
Design Number	232086		
Class	09-03		
1)Director General Defence Research & Development Organisation Ministry of Defence Government of India, Room No. 348, B-Wing, DRDO Bhawan, Rajaji Marg, New Delhi-110105, India			
Date of Registration	19/10/2010		
Title	Leech Rearing Chamber		
Priority NA			
Design Number	233251		
Class	23-02		
1)Hindustan Unilever Ltd. Hindustan Lever House 165-166 Backbay Reclamation, Mumbai-400 020, Maharashtra, India.			
Date of Registration	14/12/2010		
Title	Block for Toilet Bowl		
Priority			
Priority Number	Date	Country	
001221477	23/06/2010	OHIM	

Design Number	233257		
Class	23-02		
1)Hindustan Unilever Ltd. Hindustan Lever House 165-166 Backbay Reclamation, Mumbai-400 020, Maharashtra, India.			
Date of Registration	14/12/2010		
Title	Block for Toilet Bowl		
Priority			
Priority Number	Date	Country	
001221477	23/06/2010	OHIM	
Design Number	233280		
Class	09-03		
1)M/s. Pashupati Dairies Private Limited NH-73, Village Kumharhera, Dehrdun Road, Saharanpur-247001, U.P.,			
Date of Registration	15/12/2010		
Title	Packaging Container		
Priority NA			
Design Number	233306		
Class	06-08		
1)Mainetti (Uk) Limited Annfield Estate, Oxnam Road, Jedburgh, Roxburghshire, Scotland, TD8 6NN, United Kingdom			
Date of Registration	16/12/2010		
Title	Garment Hanger		
Priority			
Priority Number	Date	Country	
4015941	18/06/2010	U.K.	

Design Number	233316		
Class	23-02		
1)Hindustan Unilever Ltd. Hindustan Lever House 165-166 Backbay Reclamation, Mumbai-400 020, Maharashtra, India.			
Date of Registration	16/12/2010		
Title	Toilet Block Applicator for Toilet Bowl		
Priority			
Priority Number	Date	Country	
001221469	23/06/2010	OHIM	
Design Number	233402		
Class	09-03		
1)Sumitomo Electric Industries Ltd 5-33,Kitahama 4-Chome, Chuo-ku Osaka -shi Osaka-5410041			
Date of Registration	20/12/2010		
Title	Carrying Case For An Optical Fiber Cutter		
Priority			
Priority Number	Date	Country	
2010-015752	28/06/2010	Japan	
Design Number	233431		
Class	10-03		
1)Sunny Scientific International 8/B/UA-3, Jawahar Nagar, Delhi-110007			
Date of Registration	21/12/2010		
Title	Time Measuring Instruments (Timer For Use In Sports)		
Priority NA			



Design Number	233466		
Class	07-02		
1)Access Business Group International LLC 7575 Fulton Street East Ada, Michigan 49355 U.S.A.,			
Date of Registration	22/12/2010		
Title	Handle For Cooking Vessel Ltd		
Priority			
Priority Number	Date	Country	
29/365, 255	07/07/2010	U.S.A.	
Design Number	235188		
Class	09-01		
1)Real Drinks Private Limited Mascarenhas Building 3rd Floor M.G Road Panjim Goa 403001 India			
Date of Registration	14/03/2011		
Title	Bottle		
Priority NA			
Design Number	235230		
Class	08-06		
1)Mr. Tuleshbhai Dayaljibhai Patel "Krishna", Nr. Arya Dairy Farm. Leuva Patel Boarding Main Road, Mavdi Plot, Rajkot. Gujarat-India			
Date of Registration	15/03/2011		
Title	Knob		
Priority NA			



Design Number	235231	
Class	08-06	
1)Mr. Tuleshbhai Dayaljibhai Patel "Krishna", Nr. Arya Dairy Farm. Leuva Patel Boarding Main Road, Mavdi Plot, Rajkot. Gujarat-India		
Date of Registration	15/03/2011	
Title	Knob	
Priority NA		
Design Number	235345	
Class	06-01	
1)Godrej & Boyce Mfg Co. Ltd., 1913, Division: Interio, of Pirojshanagar, Vikhroli, Mumbai-400079, Maharashtra, India		
Date of Registration	18/03/2011	
Title	CHAIR	
Priority NA		
Design Number	235361	
Class	23-04	
1)Crompton Greaves Limited., Avantha House, 6th Floor, Dr. Annie Besant Road, Worli, Mumbai-400030, Maharashtra, India		
Date of Registration	21/03/2011	
Title	Wall Fan	
Priority NA		

Design Number	235362	
Class	26-05	
1)Crompton Greaves Limited., Avantha House, 6th Floor, Dr. Annie Besant Road, Worli, Mumbai-400030, Maharashtra, India		
Date of Registration	21/03/2011	
Title	Task Light	
Priority NA		
Design Number	235364	
Class	26-05	
1)Crompton Greaves Limited., Avantha House, 6th Floor, Dr. Annie Besant Road, Worli, Mumbai-400030, Maharashtra, India		
Date of Registration	21/03/2011	
Title	Task Light	
Priority NA		
Design Number	235368	
Class	23-04	
1)Crompton Greaves Limited., Avantha House, 6th Floor, Dr. Annie Besant Road, Worli, Mumbai-400030, Maharashtra, India		
Date of Registration	21/03/2011	
Title	Ceiling Fan	
Priority NA		

Design Number	235370	
Class	23-04	
1)Crompton Greaves Limited., Avantha House, 6th Floor, Dr. Annie Besant Road, Worli, Mumbai-400030, Maharashtra, India		
Date of Registration	21/03/2011	
Title	Exhaust Fan	
Priority NA		
Design Number	235371	
Class	23-04	
1)Crompton Greaves Limited., Avantha House, 6th Floor, Dr. Annie Besant Road, Worli, Mumbai-400030, Maharashtra, India		
Date of Registration	21/03/2011	
Title	Table Fan	
Priority NA		
Design Number	235372	
Class	23-04	
1)Crompton Greaves Limited., Avantha House, 6th Floor, Dr. Annie Besant Road, Worli, Mumbai-400030, Maharashtra, India		
Date of Registration	21/03/2011	
Title	Table Fan	
Priority NA		

Design Number	235374	
Class	13-01	
1)Crompton Greaves Limited., Avantha House, 6th Floor, Dr. Annie Besant Road, Worli, Mumbai-400030, Maharashtra, India		
Date of Registration	21/03/2011	
Title	Pump	
Priority NA		
Design Number	235377	
Class	23-04	
1)Crompton Greaves Limited., Avantha House, 6th Floor, Dr. Annie Besant Road, Worli, Mumbai-400030, Maharashtra, India		
Date of Registration	21/03/2011	
Title	Ceiling Fan	
Priority NA		
Design Number	235380	
Class	23-04	
1)Khaitan (India) Limited 46 C, Jawahar Lal Nehru Road, Kolkata 700071, West Bengal, India		
Date of Registration	21/03/2011	
Title	Air Cooler	
Priority NA		

Design Number	235390	
Class	12-11	
1)Ulpa Products C-21, Sainath Niwas, Shivaji Road, Kurar, Malad (East), Mumbai-400097., Maharashtra, India		
Date of Registration	21/03/2011	
Title	Handle Grip Cover	
Priority NA		
Design Number	235395	
Class	09-01	
1)Shree Balaji Metal Industries., Plot No.22, Survey No.93/94, Golani Industrial Complex, Waliv, Vasai (E) - 401208., DIST:THANE, State of Maharashtra, (India)		
Date of Registration	22/03/2011	
Title	Bottle	
Priority NA		
Design Number	235401	
Class	12-16	
1)Tata Motors Limited Bombay House, 24 Homi Mody Street, Hutama Chowk, Mumbai 400001., Maharashtra, India		
Date of Registration	22/03/2011	
Title	Wheel Cover For Vehicle	
Priority NA		

Design Number	235408	
Class	07-05	
1) Bajaj Electricals Limited 45/47, Veer Nariman Road, Mumbai 400023, State of Maharashtra, India		
Date of Registration	22/03/2011	
Title	Iron	
Priority NA		
Design Number	235409	
Class	09-03	
1) Manika Moulds Pvt. Ltd. 601-605, 6th Floor Guffic Compound, Midc Andheri (E) Mumbai 400039 Maharashtra India		
Date of Registration	22/03/2011	
Title	Battery Container.	
Priority NA		
Design Number	235410	
Class	13-02	
1) Manika Moulds Pvt. Ltd. 601-605, 6th Floor Guffic Compound, Midc Andheri (E) Mumbai 400039 Maharashtra India		
Date of Registration	22/03/2011	
Title	Battery Container.	
Priority NA		

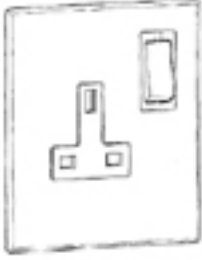
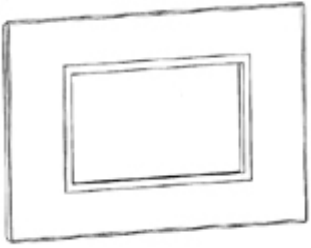
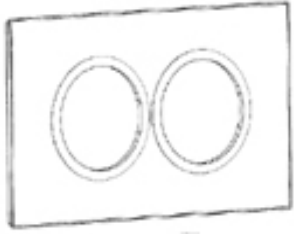
Design Number	210591		
Class	13-03		
1)Legrand France 128, Avenue Du Marechal De Lattre-De-Tassigny, Fr-87000 Limoges (France)			
Date of Registration	04/06/2007		
Title	Electrical Switch Board Containing Switch & Socket		
Priority			
Priority Number	Date	Country	
000646047	07/12/2006	EUROPEAN UNION	
Design Number	210595		
Class	13-03		
1)Legrand France 128, Avenue Du Marechal De Lattre-De-Tassigny, Fr-87000 Limoges (France)			
Date of Registration	04/06/2007		
Title	Plate For Electrical Switch Board		
Priority			
Priority Number	Date	Country	
000646047	07/12/2006	EUROPEAN UNION	
Design Number	210596		
Class	13-03		
1)Legrand France 128, Avenue Du Marechal De Lattre-De-Tassigny, Fr-87000 Limoges (France)			
Date of Registration	04/06/2007		
Title	Plate For Electrical Switch Board		
Priority			
Priority Number	Date	Country	
000646047	07/12/2006	EUROPEAN UNION	

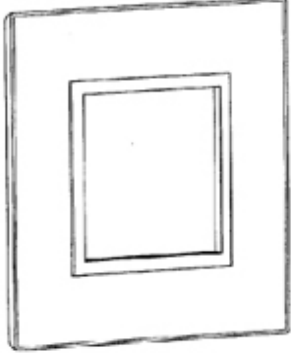
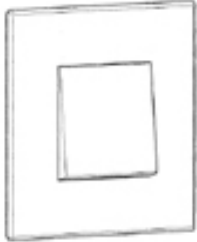
Design Number	210598		
Class	13-03		
1)Legrand France 128, Avenue Du Marechal De Lattre-De-Tassigny, Fr-87000 Limoges (France)			
Date of Registration	04/06/2007		
Title	Plate For Electrical Switch Board		
Priority			
Priority Number	Date	Country	
000646047	07/12/2006	EUROPEAN UNION	
Design Number			
210599			
Class	13-03		
1)Legrand France 128, Avenue Du Marechal De Lattre-De-Tassigny, Fr-87000 Limoges (France)			
Date of Registration	04/06/2007		
Title	Electrical Switch Board Containing Switch		
Priority			
Priority Number	Date	Country	
000646047	07/12/2006	EUROPEAN UNION	
Design Number			
228353			
Class	09-01		
1)Plastocraft India 38, New Unique Industrial Estate, Dr. R. P. Road, Mulund (West) Mumbai 400080			
Date of Registration	01/04/2010		
Title	Soap Dish		
Priority NA			

Design Number	230798	
Class	12-16	
1)Honda Motor Co., Ltd., 1-1, Minami-Aoyama 2-chome, Minato-ku, 107-8556, Tokyo, Japan		
Date of Registration	11/08/2010	
Title	Car Body	
Priority		
Priority Number	Date	Country
29/355, 682	11/02/2010	U.S.A.

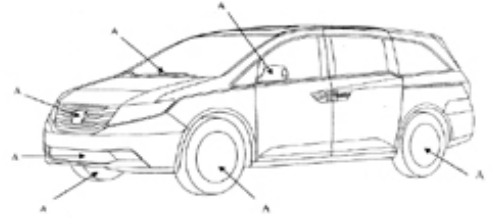



Design Number	230887	
Class	26-01	
1)Gemco A-71, Bhatti Street, Moradabad, Uttar Pradesh-244001, India		
Date of Registration	16/08/2010	
Title	Electrical Lamp	
Priority NA		





Design Number	230942	
Class	09-01	
1)Shaik Kareemullah Dairy Den, 33-S-D. Road, Secundrabad, Andhrapradesh, India		
Date of Registration	18/08/2010	
Title	Ice Cream Scoop Container	
Priority NA		

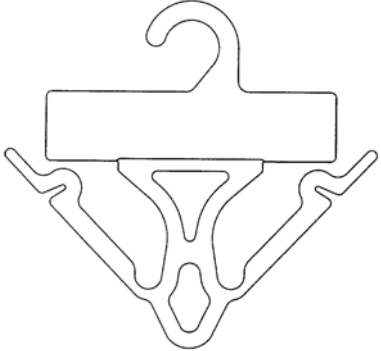

Design Number	230947	
Class	07-01	
1)Glister Sachet India Pvt. Ltd., Plot No. 60 & 61, Kinfra Industrial Park, Kakkanchery, Malappuram Dist., State Kerala		
Date of Registration	18/08/2010	
Title	Dish	
Priority NA		
Design Number	232634	
Class	22-06	
1)Louis Devadass Hou. No. 590, 6th "G" Cross, 6th Block Koramangala. Bangalore-95 Kar. 560095 India		
Date of Registration	15/11/2010	
Title	Mosquito Killing Device	
Priority NA		
Design Number	232638	
Class	22-06	
1)Louis Devadass Hou.No", 590, 6th "G" Cross, 6th Block Koramangala. Bangalore-95 Kar. 560095 India		
Date of Registration	15/11/2010	
Title	Mosquito Killing Device	
Priority NA		

Design Number	232664		
Class	02-02		
1)Mahotsav Creation Pvt. Ltd., "Mahotsav House" No.6, Rathi Palace, Ring Road, Surat-385002,			
Date of Registration	16/11/2010		
Title	Saree and Blouse Set		
Priority NA			
Design Number	232685		
Class	12-16		
1)JCB India Limited B-1/1-1, 2nd Floor, Mohan Co-operative Industrial Estate, Mathura Road, New Delhi, India			
Date of Registration	16/11/2010		
Title	Main Frame And Ram Guard Assembly For Pick And Carry Crane		
Priority NA			
Design Number	232736		
Class	06-08		
1)Mainetti (UK) Limited Annfield Estate, Oxnam Road, Jedburgh, Roxburghshire, Scotland, TD8 6NN, United Kingdom			
Date of Registration	19/11/2010		
Title	Hanger For Attaching To A Box		
Priority			
Priority Number	Date	Country	
4015658	20/05/2010	U.K.	

Design Number	232741	
Class	12-16	
1)Tata Motors Limited Bombay House, 24 Homi Mody Street, Hutatma Chowk, Mumbai 400001, Maharashtra, India		
Date of Registration	19/11/2010	
Title	Plenum Cover For Vehicle	
Priority NA		
Design Number	235048	
Class	26-05	
1)Minda Industries Limited Vill, Nawada Fatepur, P.O. Sikanderpur Badda, Manesar, Distt. Gurgaon, Haryana-122004, India		
Date of Registration	08/03/2011	
Title	Led-Front Fog Lamp for Vehicle	
Priority NA		
Design Number	232185	
Class	24-02	
1)G.V.G. Publishers 1-6-34, 4th Floor, Uma Millennium, Park Lane, Secunderabad-500003, A.P. India		
Date of Registration	21/10/2010	
Title	Electronic Medical Records Storage Device	
Priority NA		



Design Number	232190		
Class	24-02		
1)G.V.G. Publishers 1-6-34, 4th Floor, Uma Millennium, Park Lane, Secunderabad-500003, A.P. India			
Date of Registration	21/10/2010		
Title	Electronic Medical Records Storage Device		
Priority NA			
Design Number	232266		
Class	12-08		
1)Bajaj Auto Limited New No. 6, Old No. 157, II Floor, Habibullah Road, T. Nagar, Chennai-600017, State of Tamil Nadu, India			
Date of Registration	25/10/2010		
Title	Auto Rickshaw		
Priority NA			
Design Number	232330		
Class	09-03		
1)Hindustan Unilever Limited Hindustan Lever House 165-166 Backbay Reclamation, Mumbai 400020, State of Maharashtra, India			
Date of Registration	26/10/2010		
Title	Box		
Priority			
Priority Number	Date	Country	
001706011-0001	10/05/2010	OHIM	



Design Number	232333	 <p>PERSPECTIVE VIEW</p>
Class	13-03	
1)Siemens Ltd., 130, Pandurang Budhkar Marg Worli, 400018 Mumbai, India		
Date of Registration	26/10/2010	
Title	Horizontal Double Break Disconnecter	
Priority NA		
Design Number	232344	
Class	08-05	
1)Lube Corporation Horizon One, 30-16, Nishi-Waseda 3-chome, Shinjuku-ku, Tokyo 169-0051, Japan		
Date of Registration	27/10/2010	
Title	Cartridge Tank	
Priority NA		
Design Number	233975	
Class	02-02	
1)Kewal Kiran Clothing Ltd., B-101, Synthofine Estate, Opp. Virwani Industrial Estate, Goregaon (East), Mumbai-400063, Maharashtra, India		
Date of Registration	19/01/2011	
Title	Pant	
Priority NA		

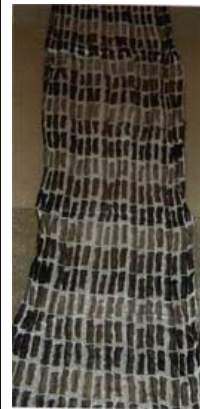
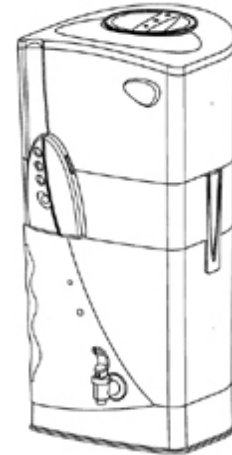

Design Number	234031	
Class	13-03	
1)Daksha Electronics Plot No. 235, G.I.D.C.-1, Nirma Road, Mehsana-384002, Gujarat-India		
Date of Registration	24/01/2011	
Title	Switch	
Priority NA		
Design Number	234098	
Class	08-09	
1)Shree Ji Udyog 423, Phase-VI, Focal Point, Ludhina-141010 (Punjab) India.,		
Date of Registration	28/01/2011	
Title	Door Closer	
Priority NA		
Design Number	234161	
Class	05-05	
1)Parry Murray & Co. Ltd., 3rd Floor, Simpson House, 6 Cherry Orchard Road, Croydon, CRO 6BA, United Kingdom		
Date of Registration	31/01/2011	
Title	Textile Fabric	
Priority NA		

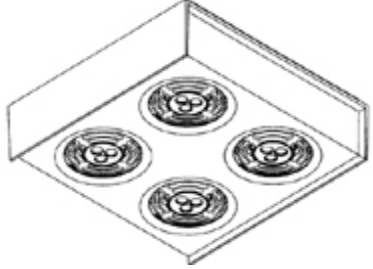

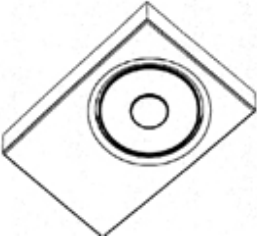
Design Number	234171	
Class	05-05	
1)Parry Murray & Co. Ltd., 3rd Floor, Simpson House, 6 Cherry Orchard Road, Croydon, CRO 6BA, United Kingdom		
Date of Registration	31/01/2011	
Title	Textile Fabric	
Priority NA		
Design Number	234182	
Class	23-01	
1)Hindustan Unilever Limited 165-166 Backabay Reclamation, Mumbai 400020, State of Maharashtra, India		
Date of Registration	31/01/2011	
Title	Water Purification Device	
Priority		
Priority Number	Date	Country
001744376-0001	17/08/2010	OHIM
Priority NA		
Design Number	223963	
Class	05-05	
1)Tal C-136, Sarvodaya Enclave, New Delhi -110017, India		
Date of Registration	23/07/2009	
Title	Textile Fabric	
Priority NA		



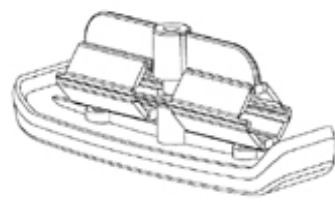

Design Number	230149		
Class	24-02		
1)Sanofi-Aventis Deutschland GmbH, Bruningstrasse 50, 65929 Frankfurt, Germany			
Date of Registration	12/07/2010		
Title	Medical Injector		
Priority			
Priority Number	Date	Country	
001188411	11/01/2010	OHIM	
Design Number	231814		
Class	31-00		
1)Hindustan Unilever Limited Hindustan Lever House 165-166 Backbay Reclamation, Mumbai 400020, State of Maharashtra, India			
Date of Registration	06/10/2010		
Title	Ice Cream Dispenser		
Priority			
Priority Number	Date	Country	
001211106-0001	27/04/2010	OHIM	
Design Number	231830		
Class	26-05		
1)Koninklijke Philips Electronics N.V., Groenewoudseweg 1, 5621 BA Eindhoven, The Netherlands			
Date of Registration	07/10/2010		
Title	Luminaire		
Priority			
Priority Number	Date	Country	
001692088-0006	08/04/2010	OHIM	

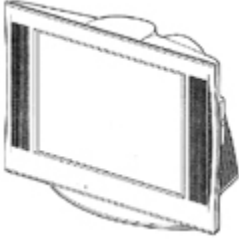

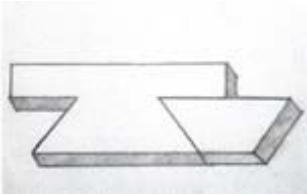
Design Number	231832		
Class	26-05		
1)Koninklijke Philips Electronics N.V., Groenewoudseweg 1, 5621 BA Eindhoven, The Netherlands			
Date of Registration	07/10/2010		
Title	Luminaire		
Priority			
Priority Number	Date	Country	
001692088-0009	08/04/2010	OHIM	
Design Number	231841		
Class	08-07		
1)Ravi Kaml Bali 506-508, Dimple Arcade, Asha Nagar, off. Western Express Highway, Kandivali (E), Mumbai-400101, Maharashtra, Mumbai			
Date of Registration	08/10/2010		
Title	Locking Device		
Priority NA			
Design Number	231940		
Class	08-08		
1)Jeon Byung Kyu 111-2305 Yongsan Lottecastle Grand, #230-10, Yongsan-dong, Dalseo-gu, Daegu, Republic of Korea			
Date of Registration	12/10/2010		
Title	Bolt For Rivet		
Priority			
Priority Number	Date	Country	
30-2010-41151	16/09/2010	Republic of Korea	

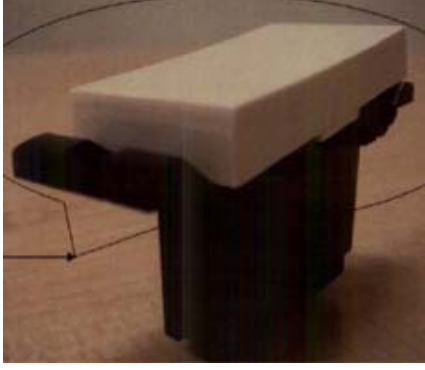
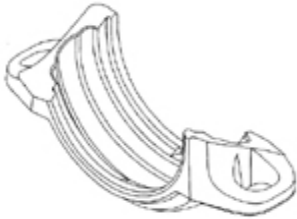

Design Number	232913		
Class	09-01		
1)M/s Gaurav Oil Mills House no. 748. Sector-7C, Faridabad (Haryana)			
Date of Registration	30/11/2010		
Title	Bottle		
Priority NA			
Design Number	232918		
Class	13-03		
1)Trelleborg Industrial Products Finland Oy Kikkerlantie 72, 38300 Sastamala Finland			
Date of Registration	30/11/2010		
Title	Cable Gland Module		
Priority			
Priority Number	Date	Country	
001218358	01/06/2010	OHIM	
Design Number	232922		
Class	09-99		
1)Chok-a-Blok Ltd., 11 Wood Lane Bournemouth, Dorset BH11 9NG, United Kingdom			
Date of Registration	30/11/2010		
Title	Corner Protectors For Packaging		
Priority			
Priority Number	Date	Country	
001714395-0003	01/06/2010	OHIM	

Design Number	234575		
Class	14-03		
1)Lg Electronics Inc., 20 Yeouido-Dong, Yeongdeungpo-Gu, Seoul 150-721 Republic of Korea			
Date of Registration	15/02/2011		
Title	Television Receiver		
Priority			
Priority Number	Date	Country	
30-2010-0038174	31/08/2010	Republic of Korea	
Design Number	217034		
Class	14-02		
1)Apple Inc., 1 Infinite Loop, Cupertino, California 95014, Usa.			
Date of Registration	07/07/2008		
Title	Electronic Device		
Priority			
Priority Number	Date	Country	
29/294,335	04/01/2008	U.S.A.	
Design Number	229541		
Class	25-01		
1)Abhishek Pandey 4B/6/1, Bhilai 490001, Chhatisgarh India			
Date of Registration	28/05/2010		
Title	Girder Block		
Priority NA			

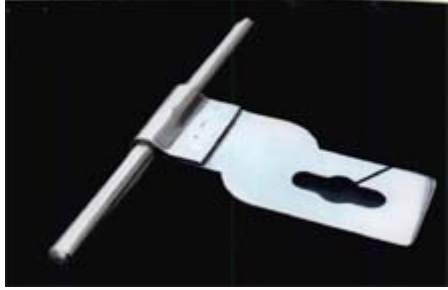
Design Number	229555	
Class	09-07	
1)V2 Corp., WZ-8/1, Industrial Area Kirti Nagar, New Delhi-110015, India		
Date of Registration	28/05/2010	
Title	Cap of Bottle	
Priority NA		
Design Number	231156	
Class	15-07	
1)Tank Mobile Kiosks Limited 23/F., Suite C, EGL Tower, 83 Hung To Road, Kwun Tong, Kowloom, Hong Kong, China		
Date of Registration	30/08/2010	
Title	Refrigerated Display	
Priority NA		
Design Number	231178	
Class	07-01	
1)Ravissant Pvt. Ltd., 50-51, Commercial Complex, New Friends Colony, New Delhi-110065		
Date of Registration	31/08/2010	
Title	Bowl	
Priority NA		

Design Number	231212	
Class	13-03	
1)Wipro Limited Doddakanneli, Sarjapur Road, Bangalore-560035, Karnataka, India.		
Date of Registration	01/09/2010	
Title	Switch	
Priority NA		
Design Number	231231	
Class	23-01	
1)Victaulic Company 4901 Kesslersville Road, Easton, Pennsylvania 18040, United States of America		
Date of Registration	02/09/2010	
Title	Pipe Coupling Unit	
Priority NA		
Design Number	233122	
Class	23-01	
1)Variant Polylink 4, Shree Narayan Estate, Plot No.26, IDC, Nr., A.E.C., S/s. Odhav, Ahmedabad-382415., (Gujarat), India		
Date of Registration	08/12/2010	
Title	Ball Valve	
Priority NA		

Design Number	233163		
Class	22-04		
1)Laporte Holding 357 Allee Du Val De Pome 06410 Biot, France			
Date of Registration	09/12/2010		
Title	Bow Target		
Priority			
Priority Number	Date	Country	
001724154	25/06/2010	OHIM	
Design Number	234682		
Class	08-09		
1)Shilpa Metal Industries B-5, Friends Industrial Estate, Sherpur, Focal Point, LUDHIANA-141010 (PUNJAB) INDIA			
Date of Registration	22/02/2011		
Title	Aldrop		
Priority NA			
Design Number	234751		
Class	06-11		
1)M/s. S.N. Kapoor Export Khawasji Ka Bagh, Amer Road, Jaipur-302002 (Raj.)			
Date of Registration	25/02/2011		
Title	Carpet		
Priority NA			

Design Number	234791		
Class	12-16		
1)M/s. Jay Ushin Ltd., GP-14, HSIDC Industrial Estate, Sector-18, Gurgaon-122001, (Haryana), India			
Date of Registration	28/02/2011		
Title	Contact Neutral Switch For Vehicles		
Priority NA			
Design Number	231256		
Class	15-04		
1)Vectra Advanced Engineering Pvt. Ltd., Plot No. 22, Udyog Vihar, Greater Noida, P.O. Surajpur, Uttar Pradesh-201306, India.			
Date of Registration	06/09/2010		
Title	Skid Steer Loader.		
Priority NA			
Design Number	231306		
Class	03-01		
1)Panasonic Corporation 1006, Oaza Kadoma, Kadoma-shi, Osaka 571-8501, Japan			
Date of Registration	07/09/2010		
Title	Case for Radio Telephone.		
Priority			
Priority Number	Date	Country	
2010-005519	08/03/2010	Japan	

Design Number	231350	
Class	14-03	
1)Modern Communication & Broadcast Systems Private Limited M-25/223, Vidyanagar Society, Nr. Himatlal Park, Panjara Pole, Ahmedabad-380015., Gujarat, India		
Date of Registration	10/09/2010	
Title	Dish Antenna	
Priority NA		
Design Number	231386	
Class	08-09	
1)Kamal Bhagwandas Lalwani A-77, Radhe Bungalows, Opp.Khokhra Circle, Ahmedabad-380008. (Gujarat), India		
Date of Registration	13/09/2010	
Title	Telescopic Drawer Channel	
Priority NA		
Design Number	231395	
Class	11-02	
1)B & V Design Pvt. Ltd., F-1102, Chittranjan Park, New Delhi-110019, India		
Date of Registration	14/09/2010	
Title	Flower Vase	
Priority NA		

Design Number	231471	
Class	14-01	
1)Phl Audio 461 rue des Chenes, 77590 Chartrettes, France		
Date of Registration	16/09/2010	
Title	Casing For Loudspeakers	
Priority		
Priority Number	Date	Country
001682204-0001	16/03/2010	OHIM





Design Number	233784	
Class	14-03	
1)Shenzhen Newplan Design Co., Ltd., 2F Building A, M-space, Nanhai Avenue South, Shekou, Nanshan District, Shenzhen City, Guangdong Province, China		
Date of Registration	07/01/2011	
Title	Mobile Phone	
Priority NA		



Design Number	233803	
Class	15-07	
1)BEHR A/s Magevej 14 A, 8370 Hadsten, Denmark		
Date of Registration	10/01/2011	
Title	Doors For Refrigerated Sales Counters	
Priority		
Priority Number	Date	Country
1729823	09/07/2010	OHIM



Design Number	233818		
Class	15-05		
1)Panasonic Corporation 1006, Oaza Kadoma, Kandoma-shi, Osaka 571-8501, Japan			
Date of Registration	11/01/2011		
Title	Vacuum Cleaner		
Priority			
Priority Number	Date	Country	
2010-017418	16/07/2010	Japan	
Design Number	233894		
Class	09-07		
1)Omega Fine Chemicals 803/B, Omkar "A", 88, Bal Govindas Road, Mahim, Mumbai 400016, Maharashtra, India			
Date of Registration	14/01/2011		
Title	Can Adapter		
Priority NA			
Design Number	235752		
Class	12-16		
1)Jcb India Limited B-1/1-1, 2nd Floor, Mohan co-operative Industrial Estate, Mathura Road, New Delhi, India and works at 23/7, Mathura Road, Ballabgarh, Haryana, India			
Date of Registration	28/03/2011		
Title	Front Grill For Backhoe Loader		
Priority NA			