

INTRODUCTION

In view of the recent amendment made in the Designs (Amendment) Rules, 2008 with effect from 17/06/2008, Publication of the matter relating to Designs is being published in the Official Journal of The Patent Office. This Journal is being published on weekly basis on every Friday covering the various proceedings on Designs as required according to the provisions of under Rule 22, 25, 27 and 39 of the Design (Amendment) Rules, 2008. All the enquiries on this Official Journal and other information as required by the public should be addressed to the Controller General of Patents, Designs & Trade Marks. Suggestions and comments are requested from all quarters so that the content can be enriched.



COPYRIGHT PUBLICATION



SL NO	CASE NUMBERS	RENEWED ON
1.	176280	30.08.2011
2.	186235	26.08.2011
3.	186285	26.08.2011
4.	186236	26.08.2011
5.	225901	22.08.2011
6.	187873	22.08.2011
7.	186237	29.08.2011
8.	187728	29.08.2011
9.	184175	25.08.2011
10.	184715	29.08.2011
11.	186470	29.08.2011
12.	186471	30.08.2011
13.	218550	29.08.2011
14.	225647	29.08.2011
15.	216202	29.08.2011
16.	209798	29.08.2011
17.	224544	22.08.2011
18.	186335	26.08.2011
19.	186314	29.08.2011
20.	186840	29.08.2011



REGISTRATION OF DESIGNS

The following designs have been registered. They are now open for public inspection. In the following each entry the Date of Registration is shown. The Priority Number, Priority Date and Priority Country are also shown

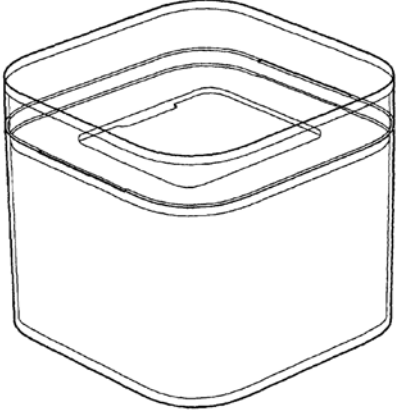
Design Number	232702	
Class	09-03	
1)Ite Limited Virginia House, 37, J.L. Nehru Road, Kolkata 700071, West Bengal, India		
Date of Registration	16/11/2010	
Title	Cigarette Pack	
Priority NA		
Design Number	234214	
Class	09-05	
1)Emami Limited "Emami Tower", 687 Anandapur, EM Bypass, Kolkata 700107, West Bengal, India		
Date of Registration	01/02/2011	
Title	Tube	
Priority NA		
Design Number	234215	
Class	09-05	
1)Emami Limited "Emami Tower", 687 Anandapur, EM Bypass, Kolkata 700107, West Bengal, India		
Date of Registration	01/02/2011	
Title	Tube	
Priority NA		

Design Number	231180		
Class	11-02		
1)Ravissant Pvt. Ltd., 50-51, Commercial Complex, New Friends Colony, New Delhi-110065			
Date of Registration	31/08/2010		
Title	Decorative Article		
Priority NA			
Design Number	233192		
Class	09-05		
1)The Gillette Company IP/Legal Patent Department-3E, One Gillette Park, Boston, 02127, United States of America			
Date of Registration	10/12/2010		
Title	Packaging		
Priority			
Priority Number	Date	Country	
29/364, 146	18/06/2010	U.S.A.	
Design Number	234758		
Class	06-11		
1)M/s. S.N. Kapoor Export Khawasji Ka Bagh, Amer Road, Jaipur-302002 (Raj.)			
Date of Registration	25/02/2011		
Title	Carpet		
Priority NA			



Design Number	234781		
Class	09-03		
1)Apple Inc. 1 Infinite Loop, Cupertino, California 95014 United States of America			
Date of Registration	25/02/2011		
Title	Packaging		
Priority			
Priority Number	Date	Country	
29/368, 992	31/08/2010	U.S.A.	
Design Number	234790		
Class	09-01		
1)Rustagi Plastic Industries Private Ltd., Plot No. 812/E-8-9, Samtel Zone, Bhiwadi Indl. Area, Distt. Alwar (Raj) 301019, India			
Date of Registration	28/02/2011		
Title	Bottle		
Priority NA			
Design Number	234803		
Class	29-02		
1)Mallcom (India) Limited Mallcom Tower, EN 12, Sector -V, Salt Lake City, Kolkata-700091, West Bengal			
Date of Registration	28/02/2011		
Title	Protective Helmet		
Priority NA			



Design Number	234804	
Class	29-02	
1)Mallcom (India) Limited Mallcom Tower, EN 12, Sector -V, Salt Lake City, Kolkata-700091, West Bengal		
Date of Registration	28/02/2011	
Title	Protective Helmet	
Priority NA		
Design Number	234831	
Class	19-06	
1)Cello Plastic Products Private Limited 5, Vakil Industrial Estate, Walbhat Road, Goregaon (East), Mumbai-400063, Maharashtra, Mumbai		
Date of Registration	28/02/2011	
Title	Pen	
Priority NA		
Design Number	234835	
Class	19-06	
1)Cello Plastic Products Private Limited 5, Vakil Industrial Estate, Walbhat Road, Goregaon (East), Mumbai-400063, Maharashtra, Mumbai		
Date of Registration	28/02/2011	
Title	Pen	
Priority NA		

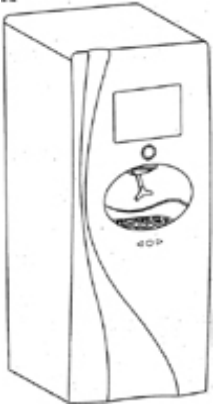

Design Number	234843	
Class	09-01	
1) Lotus Beverages Private Limited S-2 & 3, Second Floor, Malik Buildcon Plaza-1, Plot No.- 2, Pocket-6, Sector-12, Dwarka, New Delhi-110075, India		
Date of Registration	01/03/2011	
Title	Bottle	
Priority NA		

Design Number	234885	
Class	11-01	
1) Yash Agarwal 9, Laxmi Complex, M.I. Road, Jaipur (Raj)., India		
Date of Registration	03/03/2011	
Title	Bracelet	
Priority NA		



Design Number	234887	
Class	11-01	
1) Yash Agarwal 9, Laxmi Complex, M.I. Road, Jaipur (Raj)., India		
Date of Registration	03/03/2011	
Title	Bracelet	
Priority NA		



Design Number	234899		
Class	11-01		
1)Yash Agarwal 9, Laxmi Complex, M.I. Road, Jaipur (Raj)., India			
Date of Registration	03/03/2011		
Title	Earring		
Priority NA			
Design Number	232241		
Class	31-00		
1)The Coca-Cola Company One Coca-Cola Plaza NW, Atlanta, Georgia 30313, USA			
Date of Registration	22/10/2010		
Title	Beverage Dispenser		
Priority			
Priority Number	Date	Country	
29/360484	27/04/2010	U.S.A.	
Design Number	232242		
Class	31-00		
1)The Coca-Cola Company One Coca-Cola Plaza NW, Atlanta, Georgia 30313, USA			
Date of Registration	22/10/2010		
Title	Beverage Dispenser		
Priority			
Priority Number	Date	Country	
29/360484	27/04/2010	U.S.A.	

Design Number	233918	
Class	08-06	
1)Oswal Hardware 107, Keshavji Nayak Road, Hingwala Bldg. Room No 43/44 4th Floor Masjid Bunder Mumbai - 400009 India		
Date of Registration	14/01/2011	
Title	Handle	
Priority NA		
Design Number	235429	
Class	08-09	
1)Dorma India Private Limited 14, Pattulous Road, Chennai-600002, Tamil Nadu, India		
Date of Registration	22/03/2011	
Title	Metal Fitting - Rod Holder	
Priority NA		
Design Number	235542	
Class	26-03	
1)Crompton Greaves Limited., Avantha House, 6th Floor, Dr. Annie Besant Road, Worli, Mumbai-400030, Maharashtra, India		
Date of Registration	28/03/2011	
Title	Lighting Fixture	
Priority NA		



Design Number	235543	
Class	26-03	
1)Crompton Greaves Limited., Avantha House, 6th Floor, Dr. Annie Besant Road, Worli, Mumbai-400030, Maharashtra, India		
Date of Registration	28/03/2011	
Title	Lighting Fixture (Led Round Pendant)	
Priority NA		
Design Number	235545	
Class	26-03	
1)Crompton Greaves Limited., Avantha House, 6th Floor, Dr. Annie Besant Road, Worli, Mumbai-400030, Maharashtra, India		
Date of Registration	28/03/2011	
Title	Lighting Fixture	
Priority NA		
Design Number	235546	
Class	26-03	
1)Crompton Greaves Limited., Avantha House, 6th Floor, Dr. Annie Besant Road, Worli, Mumbai-400030, Maharashtra, India		
Date of Registration	28/03/2011	
Title	Lighting Fixture	
Priority NA		

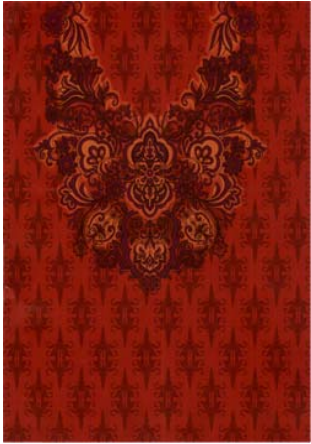

Design Number	235562	
Class	13-03	
1)Crompton Greaves Limited., Avantha House, 6th Floor, Dr. Annie Besant Road, Worli, Mumbai-400030, Maharashtra, India		
Date of Registration	28/03/2011	
Title	Vacuum Contactor	
Priority NA		
Design Number	235565	
Class	26-03	
1)Crompton Greaves Limited., Avantha House, 6th Floor, Dr. Annie Besant Road, Worli, Mumbai-400030, Maharashtra, India		
Date of Registration	28/03/2011	
Title	Lighting Fixture (Led Down Lighter)	
Priority NA		
Design Number	235575	
Class	13-03	
1)Crompton Greaves Limited., Avantha House, 6th Floor, Dr. Annie Besant Road, Worli, Mumbai-400030, Maharashtra, India		
Date of Registration	28/03/2011	
Title	Transformer Tank	
Priority NA		

Design Number	235579	
Class	23-04	
1)Crompton Greaves Limited., Avantha House, 6th Floor, Dr. Annie Besant Road, Worli, Mumbai-400030, Maharashtra, India		
Date of Registration	28/03/2011	
Title	Ceiling Fan (Olga 600)	
Priority NA		
Design Number	235586	
Class	26-03	
1)Crompton Greaves Limited., Avantha House, 6th Floor, Dr. Annie Besant Road, Worli, Mumbai-400030, Maharashtra, India		
Date of Registration	28/03/2011	
Title	Lighting Fixture.	
Priority NA		
Design Number	235588	
Class	13-03	
1)Crompton Greaves Limited., Avantha House, 6th Floor, Dr. Annie Besant Road, Worli, Mumbai-400030, Maharashtra, India		
Date of Registration	28/03/2011	
Title	Transformer Tank	
Priority NA		

Design Number	235603	
Class	05-05	
1)BIBA APPARELS PVT. LTD., 45-54, "Whitehall", Kemps Corner, 143 A.K. Marg., Mumbai-400036, Maharashtra, India		
Date of Registration	28/03/2011	
Title	Textile Fabric	
Priority NA		
Design Number	235609	
Class	05-05	
1)Biba Apparels Pvt. Ltd., 45-54, "Whitehall", Kemps Corner, 143 A.K. Marg., Mumbai-400036, Maharashtra, India		
Date of Registration	28/03/2011	
Title	Textile Fabric	
Priority NA		
Design Number	235611	
Class	05-05	
1)Biba Apparels Pvt. Ltd., 45-54, "Whitehall", Kemps Corner, 143 A.K. Marg., Mumbai-400036, Maharashtra, India		
Date of Registration	28/03/2011	
Title	Textile Fabric	
Priority NA		

Design Number	235615	
Class	05-05	
1)Biba Apparels Pvt. Ltd., 45-54, "Whitehall", Kemps Corner, 143 A.K. Marg., Mumbai-400036, Maharashtra, India		
Date of Registration	28/03/2011	
Title	Textile Fabric	
Priority NA		
Design Number	235616	
Class	05-05	
1)Biba Apparels Pvt. Ltd., 45-54, "Whitehall", Kemps Corner, 143 A.K. Marg., Mumbai-400036, Maharashtra, India		
Date of Registration	28/03/2011	
Title	Textile Fabric	
Priority NA		
Design Number	235617	
Class	05-05	
1)Biba Apparels Pvt. Ltd., 45-54, "Whitehall", Kemps Corner, 143 A.K. Marg., Mumbai-400036, Maharashtra, India		
Date of Registration	28/03/2011	
Title	Textile Fabric	
Priority NA		



Design Number	235619	
Class	05-05	
1)Biba Apparels Pvt. Ltd., 45-54, "Whitehall", Kemps Corner, 143 A.K. Marg., Mumbai-400036, Maharashtra, India		
Date of Registration	28/03/2011	
Title	Textile Fabric	
Priority NA		
Design Number	235622	
Class	05-05	
1)Biba Apparels Pvt. Ltd., 45-54, "Whitehall", Kemps Corner, 143 A.K. Marg., Mumbai-400036, Maharashtra, India		
Date of Registration	28/03/2011	
Title	Textile Fabric	
Priority NA		
Design Number	235623	
Class	05-05	
1)Biba Apparels Pvt. Ltd., 45-54, "Whitehall", Kemps Corner, 143 A.K. Marg., Mumbai-400036, Maharashtra, India		
Date of Registration	28/03/2011	
Title	Textile Fabric	
Priority NA		

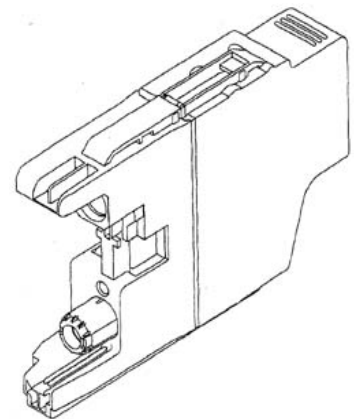
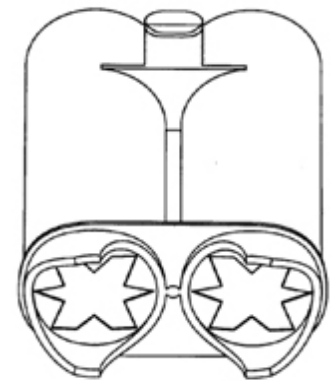

Design Number	235624	
Class	05-05	
1)Biba Apparels Pvt. Ltd., 45-54, "Whitehall", Kemps Corner, 143 A.K. Marg., Mumbai-400036, Maharashtra, India		
Date of Registration	28/03/2011	
Title	Textile Fabric	
Priority NA		
Design Number	235625	
Class	05-05	
1)Biba Apparels Pvt. Ltd., 45-54, "Whitehall", Kemps Corner, 143 A.K. Marg., Mumbai-400036, Maharashtra, India		
Date of Registration	28/03/2011	
Title	Textile Fabric	
Priority NA		
Design Number	235628	
Class	05-05	
1)Biba Apparels Pvt. Ltd., 45-54, "Whitehall", Kemps Corner, 143 A.K. Marg., Mumbai-400036, Maharashtra, India		
Date of Registration	28/03/2011	
Title	Textile Fabric	
Priority NA		

Design Number	235629	
Class	05-05	
1)Biba Apparels Pvt. Ltd., 45-54, "Whitehall", Kemps Corner, 143 A.K. Marg., Mumbai-400036, Maharashtra, India		
Date of Registration	28/03/2011	
Title	Textile Fabric	
Priority NA		
Design Number	235632	
Class	05-05	
1)Biba Apparels Pvt. Ltd., 45-54, "Whitehall", Kemps Corner, 143 A.K. Marg., Mumbai-400036, Maharashtra, India		
Date of Registration	28/03/2011	
Title	Textile Fabric	
Priority NA		
Design Number	227964	
Class	12-16	
1)Vishnu Lal 605, Asiad Village, Khel Gaon Marg, New Delhi 110049, India		
Date of Registration	22/03/2010	
Title	Driver Seat Adjusting Assembly	
Priority NA		



Design Number	231623	
Class	09-01	
1)Hi-Tec Natural Products (India) Limited 205, Jawahar Gali, Farsh Bazar, Shahdara, New Delhi-110032, India		
Date of Registration	24/09/2010	
Title	Bottle	
Priority NA		
Design Number	233319	
Class	23-02	
1)Hindustan Unilever Ltd. Hindustan Lever House 165-166 Backbay Reclamation, Mumbai-400 020, Maharashtra, India.		
Date of Registration	16/12/2010	
Title	Toilet Block Applicator for Toilet Bowl	
Priority		
Priority Number	Date	Country
001221469	23/06/2010	OHIM
Design Number	233369	
Class	14-02	
1)Brother Industries, Ltd. 15-1 Naeshiro-Cho, Mizuho-Ku, Nagoya-Shi, Aichi-Ken, Japan		
Date of Registration	20/12/2010	
Title	Ink Cartridge	
Priority		
Priority Number	Date	Country
2010-014837	17/06/2010	Japan



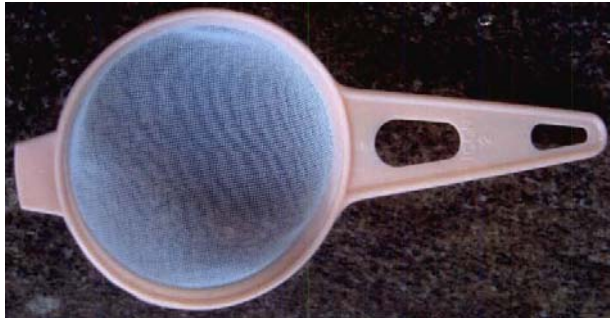

Design Number	235039	
Class	12-16	
1)Mahindra & Mahindra Ltd., Gateway Building, Apollo Bunder, Mumbai 400001., Maharashtra, India		
Date of Registration	08/03/2011	
Title	Read Bumper Of A Vehicle	
Priority NA		
Design Number	235044	
Class	12-16	
1)Minda Industries Limited Vill, Nawada Fatepur, P.O. Sikanderpur Badda, Manesar, Distt. Gurgaon, Haryana-122004, India		
Date of Registration	08/03/2011	
Title	Rear View Mirror for Vehicle	
Priority NA		
Design Number	235047	
Class	26-05	
1)Minda Industries Limited Vill, Nawada Fatepur, P.O. Sikanderpur Badda, Manesar, Distt. Gurgaon, Haryana-122004, India		
Date of Registration	08/03/2011	
Title	Led-Rear Combination Lamp for Vehicle	
Priority NA		

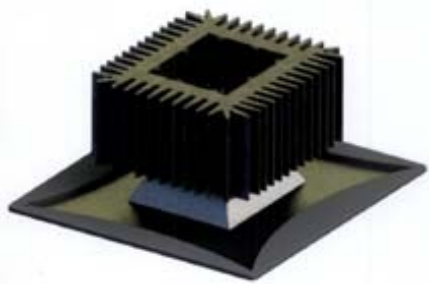

Design Number	231397	
Class	11-02	
1)B & V Design Pvt. Ltd., F-1102, Chittranjan Park, New Delhi-110019, India		
Date of Registration	14/09/2010	
Title	Flower Vase	
Priority NA		
Design Number	231398	
Class	11-02	
1)B & V Design Pvt. Ltd., F-1102, Chittranjan Park, New Delhi-110019, India		
Date of Registration	14/09/2010	
Title	Candle Holder	
Priority NA		
Design Number	233679	
Class	07-04	
1)M/s. Muskaan Industries Plot No. 108, Unit No. 3 & 4, Shakti Ind. Estate, Navghar, Vasai (East), Dist.: Thane (Maharashtra) India		
Date of Registration	03/01/2011	
Title	Tea Strainer	
Priority NA		

Design Number	235189	
Class	23-04	
1)Achal Anil Bakeri 415 Bodakdev Ahmedabad 380054 (Gujrat)		
Date of Registration	14/03/2011	
Title	Air Cooler	
Priority NA		
Design Number	235190	
Class	23-04	
1)Achal Anil Bakeri 415 Bodakdev Ahmedabad 380054 (Gujrat)		
Date of Registration	14/03/2011	
Title	Air Cooler	
Priority NA		
Design Number	235288	
Class	02-04	
1)V. N. Sales Corporation WP-82, Manjit Nagar, Basti Sheikh, Jalandhar, Punjab, (India)		
Date of Registration	17/03/2011	
Title	Sole For Footwear	
Priority NA		

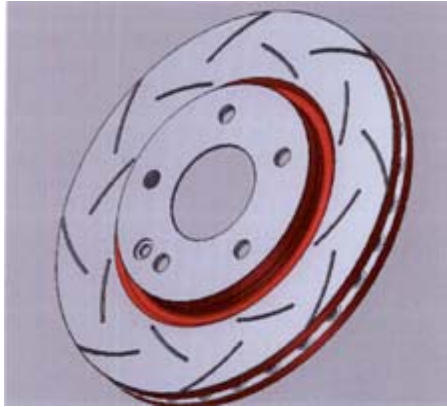
Design Number	235320	
Class	06-11	
1) Kapoor Rug Gallery AA-13, Jaiambey Nagar, Tonk Road, Jaipur-302015 (Raj), India.		
Date of Registration	18/03/2011	
Title	Carpet	
Priority NA		
Design Number	235332	
Class	08-03	
1) Falcon Industries 2524, Lane 5, Janta Nagar, Gill Road, Ludhiana-141003 (Punjab) India.,		
Date of Registration	18/03/2011	
Title	Pruning secateur	
Priority NA		
Design Number	235346	
Class	06-01	
1) Godrej & Boyce Mfg Co. Ltd., 1913, Division: Interio, of Pirojshanagar, Vikhroli, Mumbai-400079, Maharashtra, India		
Date of Registration	18/03/2011	
Title	Chair	
Priority NA		

Design Number	235373		
Class	26-03		
1)Crompton Greaves Limited., Avantha House, 6th Floor, Dr. Annie Besant Road, Worli, Mumbai-400030, Maharashtra, India			
Date of Registration	21/03/2011		
Title	Lighting Fixture		
Priority NA			
Design Number	235393		
Class	12-11		
1)Ulpa Products C-21, Sainath Niwas, Shivaji Road, Kurar, Malad (East), Mumbai-400097., Maharashtra, India			
Date of Registration	21/03/2011		
Title	Mudguards For Cycles Or Motorcycles		
Priority NA			
Design Number	233003		
Class	12-16		
1)Trw Asia Pacific Co., Ltd., 4F, 9 Building, 456 Hongcao Road, Shanghai 200233, China;			
Date of Registration	03/12/2010		
Title	Brake Rotor		
Priority			
Priority Number	Date	Country	
201030200132.1	03/06/2010	China	

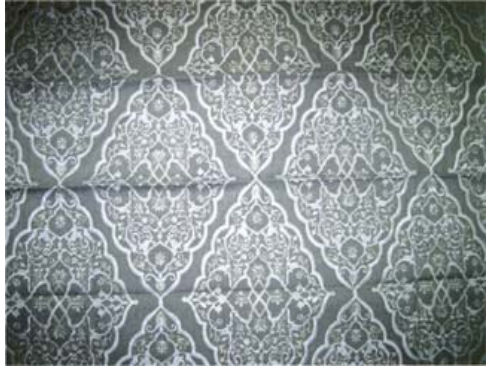

Design Number	234157	
Class	05-05	
1)Parry Murray & Co. Ltd., 3rd Floor, Simpson House, 6 Cherry Orchard Road, Croydon, CRo 6BA, United Kingdom		
Date of Registration	31/01/2011	
Title	Textile Fabric	
Priority NA		
Design Number	234159	
Class	05-05	
1)Parry Murray & Co. Ltd., 3rd Floor, Simpson House, 6 Cherry Orchard Road, Croydon, CRo 6BA, United Kingdom		
Date of Registration	31/01/2011	
Title	Textile Fabric	
Priority NA		
Design Number	234165	
Class	05-05	
1)Parry Murray & Co. Ltd., 3rd Floor, Simpson House, 6 Cherry Orchard Road, Croydon, CRo 6BA, United Kingdom		
Date of Registration	31/01/2011	
Title	Textile Fabric	
Priority NA		



Design Number	234168	
Class	05-05	
1)Parry Murray & Co. Ltd., 3rd Floor, Simpson House, 6 Cherry Orchard Road, Croydon, CR0 6BA, United Kingdom		
Date of Registration	31/01/2011	
Title	Textile Fabric	
Priority NA		
Design Number	234169	
Class	05-05	
1)Parry Murray & Co. Ltd., 3rd Floor, Simpson House, 6 Cherry Orchard Road, Croydon, CR0 6BA, United Kingdom		
Date of Registration	31/01/2011	
Title	Textile Fabric	
Priority NA		
Design Number	234175	
Class	05-05	
1)Parry Murray & Co. Ltd., 3rd Floor, Simpson House, 6 Cherry Orchard Road, Croydon, CR0 6BA, United Kingdom		
Date of Registration	31/01/2011	
Title	Textile Fabric	
Priority NA		

Design Number	235643	
Class	05-05	
1)Biba Apparels Pvt. Ltd., 45-54, "Whitehall", Kemps Corner, 143 A.K. Marg., Mumbai-400036, Maharashtra, India		
Date of Registration	28/03/2011	
Title	Textile Fabric	
Priority NA		
Design Number	235644	
Class	05-05	
1)Biba Apparels Pvt. Ltd., 45-54, "Whitehall", Kemps Corner, 143 A.K. Marg., Mumbai-400036, Maharashtra, India		
Date of Registration	28/03/2011	
Title	Textile Fabric	
Priority NA		
Design Number	235645	
Class	05-05	
1)Biba Apparels Pvt. Ltd., 45-54, "Whitehall", Kemps Corner, 143 A.K. Marg., Mumbai-400036, Maharashtra, India		
Date of Registration	28/03/2011	
Title	Textile Fabric	
Priority NA		



Design Number	235646	
Class	05-05	
1)Biba Apparels Pvt. Ltd., 45-54, "Whitehall", Kemps Corner, 143 A.K. Marg., Mumbai-400036, Maharashtra, India		
Date of Registration	28/03/2011	
Title	Textile Fabric	
Priority NA		
Design Number	235647	
Class	05-05	
1)Biba Apparels Pvt. Ltd., 45-54, "Whitehall", Kemps Corner, 143 A.K. Marg., Mumbai-400036, Maharashtra, India		
Date of Registration	28/03/2011	
Title	Textile Fabric	
Priority NA		
Design Number	235648	
Class	05-05	
1)Biba Apparels Pvt. Ltd., 45-54, "Whitehall", Kemps Corner, 143 A.K. Marg., Mumbai-400036, Maharashtra, India		
Date of Registration	28/03/2011	
Title	Textile Fabric	
Priority NA		



Design Number	235665	
Class	05-05	
1)Biba Apparels Pvt. Ltd., 45-54, "Whitehall", Kemps Corner, 143 A.K. Marg., Mumbai-400036, Maharashtra, India		
Date of Registration	28/03/2011	
Title	Textile Fabric	
Priority NA		
Design Number	235666	
Class	05-05	
1)Biba Apparels Pvt. Ltd., 45-54, "Whitehall", Kemps Corner, 143 A.K. Marg., Mumbai-400036, Maharashtra, India		
Date of Registration	28/03/2011	
Title	Textile Fabric	
Priority NA		
Design Number	235669	
Class	05-05	
1)Biba Apparels Pvt. Ltd., 45-54, "Whitehall", Kemps Corner, 143 A.K. Marg., Mumbai-400036, Maharashtra, India		
Date of Registration	28/03/2011	
Title	Textile Fabric	
Priority NA		



Design Number	235670	
Class	05-05	
1)Biba Apparels Pvt. Ltd., 45-54, "Whitehall", Kemps Corner, 143 A.K. Marg., Mumbai-400036, Maharashtra, India		
Date of Registration	28/03/2011	
Title	Textile Fabric	
Priority NA		
Design Number	235684	
Class	05-05	
1)Biba Apparels Pvt. Ltd., 45-54, "Whitehall", Kemps Corner, 143 A.K. Marg., Mumbai-400036, Maharashtra, India		
Date of Registration	28/03/2011	
Title	Textile Fabric	
Priority NA		
Design Number	235686	
Class	05-05	
1)Biba Apparels Pvt. Ltd., 45-54, "Whitehall", Kemps Corner, 143 A.K. Marg., Mumbai-400036, Maharashtra, India		
Date of Registration	28/03/2011	
Title	Textile Fabric	
Priority NA		

Design Number	235687	
Class	05-05	
1)Biba Apparels Pvt. Ltd., 45-54, "Whitehall", Kemps Corner, 143 A.K. Marg., Mumbai-400036, Maharashtra, India		
Date of Registration	28/03/2011	
Title	Textile Fabric	
Priority NA		
Design Number	235696	
Class	05-05	
1)Biba Apparels Pvt. Ltd., 45-54, "Whitehall", Kemps Corner, 143 A.K. Marg., Mumbai-400036, Maharashtra, India		
Date of Registration	28/03/2011	
Title	Textile Fabric	
Priority NA		
Design Number	235700	
Class	05-05	
1)Biba Apparels Pvt. Ltd., 45-54, "Whitehall", Kemps Corner, 143 A.K. Marg., Mumbai-400036, Maharashtra, India		
Date of Registration	28/03/2011	
Title	Textile Fabric	
Priority NA		

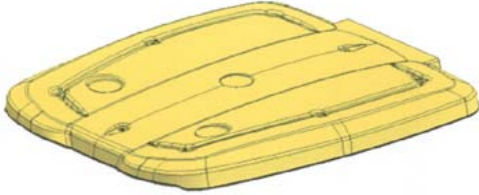
Design Number	235702	
Class	05-05	
1)Biba Apparels Pvt. Ltd., 45-54, "Whitehall", Kemps Corner, 143 A.K. Marg., Mumbai-400036, Maharashtra, India		
Date of Registration	28/03/2011	
Title	Textile Fabric	
Priority NA		
Design Number	235704	
Class	05-05	
1)Biba Apparels Pvt. Ltd., 45-54, "Whitehall", Kemps Corner, 143 A.K. Marg., Mumbai-400036, Maharashtra, India		
Date of Registration	28/03/2011	
Title	Textile Fabric	
Priority NA		
Design Number	235706	
Class	05-05	
1)Biba Apparels Pvt. Ltd., 45-54, "Whitehall", Kemps Corner, 143 A.K. Marg., Mumbai-400036, Maharashtra, India		
Date of Registration	28/03/2011	
Title	Textile Fabric	
Priority NA		

Design Number	235710	
Class	05-05	
1)Biba Apparels Pvt. Ltd., 45-54, "Whitehall", Kemps Corner, 143 A.K. Marg., Mumbai-400036, Maharashtra, India		
Date of Registration	28/03/2011	
Title	Textile Fabric	
Priority NA		
Design Number	235711	
Class	05-05	
1)Biba Apparels Pvt. Ltd., 45-54, "Whitehall", Kemps Corner, 143 A.K. Marg., Mumbai-400036, Maharashtra, India		
Date of Registration	28/03/2011	
Title	Textile Fabric	
Priority NA		
Design Number	235715	
Class	05-05	
1)Biba Apparels Pvt. Ltd., 45-54, "Whitehall", Kemps Corner, 143 A.K. Marg., Mumbai-400036, Maharashtra, India		
Date of Registration	28/03/2011	
Title	Textile Fabric	
Priority NA		

Design Number	235739	
Class	12-16	
1)Jcb India Limited B-1/1-1, 2nd Floor, Mohan co-operative Industrial Estate, Mathura Road, New Delhi, India and works at 23/7, Mathura Road, Ballabgarh, Haryana, India		
Date of Registration	28/03/2011	
Title	Roof Moulding For Backhoe Loader	
Priority NA		
Design Number	235744	
Class	12-16	
1)Jcb India Limited B-1/1-1, 2nd Floor, Mohan co-operative Industrial Estate, Mathura Road, New Delhi, India and works at 23/7, Mathura Road, Ballabgarh, Haryana, India		
Date of Registration	28/03/2011	
Title	Steering Cover (Rear) For Backhoe Loader	
Priority NA		
Design Number	235748	
Class	12-16	
1)Jcb India Limited B-1/1-1, 2nd Floor, Mohan co-operative Industrial Estate, Mathura Road, New Delhi, India and works at 23/7, Mathura Road, Ballabgarh, Haryana, India		
Date of Registration	28/03/2011	
Title	Fuse Box Cover For Backhoe Loader	
Priority NA		

Design Number	235751	
Class	12-16	
1)Jcb India Limited B-1/1-1, 2nd Floor, Mohan co-operative Industrial Estate, Mathura Road, New Delhi, India and works at 23/7, Mathura Road, Ballabgarh, Haryana, India		
Date of Registration	28/03/2011	
Title	Bumper Assembly For Backhoe Loader	
Priority NA		
Design Number	235753	
Class	12-16	
1)Jcb India Limited B-1/1-1, 2nd Floor, Mohan co-operative Industrial Estate, Mathura Road, New Delhi, India and works at 23/7, Mathura Road, Ballabgarh, Haryana, India		
Date of Registration	28/03/2011	
Title	Grill Housing For Backhoe Loader	
Priority NA		
Design Number	235773	
Class	09-01	
1)Vrajesh Corporation GF-11, Saivilla Complex, Near Sterling Mall, Old Padra Road, Vadodara, Gujarat-India		
Date of Registration	29/03/2011	
Title	Jug	
Priority NA		

Design Number	235797	
Class	02-04	
1)Alpine Polyrub Pvt. Ltd., B-23, Mangol Puri Industrial Area Phase-2, New Delhi-110034, (India)		
Date of Registration	30/03/2011	
Title	Footwear	
Priority NA		

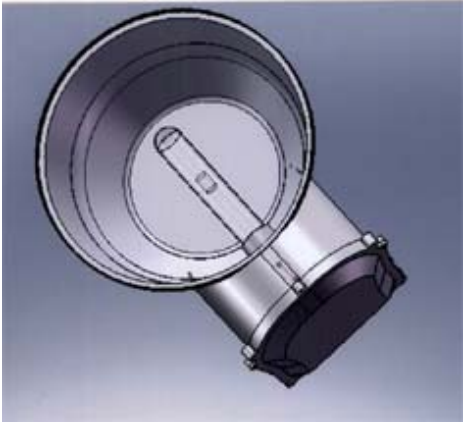
Design Number	235822	
Class	26-03	
1)Crompton Greaves Limited., Avantha House, 6th Floor, Dr. Annie Besant Road, Worli, Mumbai-400030, Maharashtra, India		
Date of Registration	31/03/2011	
Title	Lighting Fixture	
Priority NA		

Design Number	235854	
Class	26-05	
1)Crompton Greaves Limited., Avantha House, 6th Floor, Dr. Annie Besant Road, Worli, Mumbai-400030, Maharashtra, India		
Date of Registration	31/03/2011	
Title	Task Light	
Priority NA		

Design Number	226515	
Class	09-03	
1)Archimedes Development Limited Albert Einstein Centre, Nottingham Science & Technology Park, University Boulevard, Nottingham, NG7 2TN, United Kingdom		
Date of Registration	29/12/2009	
Title	Child Resistant Container	
Priority		
Priority Number	Date	Country
1156954-0001	03/07/2009	OHIM

