

CONTINUED FROM PART- 1

INTRODUCTION

In view of the recent amendment made in the Designs (Amendment) Rules, 2008 with effect from 17/06/2008, Publication of the matter relating to Designs is being published in the Official Journal of The Patent Office. This Journal is being published on weekly basis on every Friday covering the various proceedings on Designs as required according to the provisions of under Rule 22, 25, 27 and 39 of the Design (Amendment) Rules, 2008. All the enquiries on this Official Journal and other information as required by the public should be addressed to the Controller General of Patents, Designs & Trade Marks. Suggestions and comments are requested from all quarters so that the content can be enriched.

COPYRIGHT PUBLICATION

SL NO	CASE NUMBERS	RENEWED ON
1.	186653	06.09.2011
2.	186654	06.09.2011
3.	188143	08.09.2011
4.	227291	09.09.2011
5.	227292	09.09.2011
6.	223923	09.09.2011
7.	186760	09.09.2011

CANCELLATION PROCEEDINGS
under Section 19 of the Designs Act, 2000

“The Ld. Asstt. Controller of Patents & Designs passed an order on 27/9/2011 to dismiss the petition filed by Shri Bharatbhai Vrajlal Bhanderi and Shri Hiteshbhai Vrajlal Bhanderi on 24/3/2010 for cancellation of the registration of registered Design No.224326 dated 18/8/2009 under Class 13-03 titled as ‘Modular Switch Plate’ in the name of Nestone Electronics Private Limited, an Indian company having its principle place of business at 302, Ajanta Commercial Complex, Gondal Road, Rajkot-360002, Gujarat, India..”

REGISTRATION OF DESIGNS

The following designs have been registered. They are now open for public inspection. In the following each entry the Date of Registration is shown. The Priority Number, Priority Date and Priority Country are also shown

Design Number	225689	
Class	14-02	
1)Mimos Berhad Mimos Berhad, Technology Park Malaysia, 57000 Kuala Lumpur, Malaysia		
Date of Registration	09/11/2009	
Title	Sensor Data Collector Mote	
Priority		
Priority Number	Date	Country
09-00439-0101	07/05/2009	Malaysia



Design Number	225695	
Class	10-06	
1)M/s Prtro Industries 3564/55, Ravi Raj Market, Chawri Bazer, Delhi-110006, India		
Date of Registration	09/11/2009	
Title	Door Handle	
Priority NA		



Design Number	225704	
Class	08-06	
1)M/s. Shreeji Times 218, Gokulnagar 50Feet Road, Nr. Patel Nagar Rajkot-360002, Gujarat-India		
Date of Registration	09/11/2009	
Title	Handle	
Priority NA		



Design Number	225763	
Class	28-03	
1)The Gillette Company Prudential Tower Building, Boston, State of Massachusetts, United State of America		
Date of Registration	13/11/2009	
Title	Shaving razor handle	
Priority		
Priority Number	Date	Country
29/337, 058	14/05/2009	U.S.A.





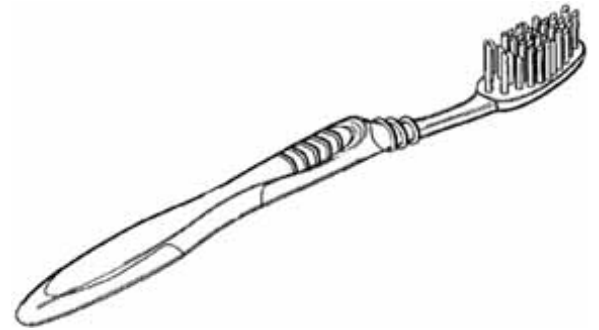



Design Number	225766	
Class	04-02	
1)Colgate-Palmolive Company Delaware Corporation, 300 Park Avenue, New York, NY 10022, USA		
Date of Registration	13/11/2009	
Title	Toothbrush.	
Priority		
Priority Number	Date	Country
29/337, 076	14/05/2009	U.S.A.







Design Number	234759	
Class	06-11	
1)M/s. S.N. Kapoor Export Khawasji Ka Bagh, Amer Road, Jaipur-302002 (Raj.)		
Date of Registration	25/02/2011	
Title	Carpet	
Priority NA		





Design Number	234760	
Class	06-11	
1)M/s. S.N. Kapoor Export Khawasji Ka Bagh, Amer Road, Jaipur-302002 (Raj.)		
Date of Registration	25/02/2011	
Title	Carpet	
Priority NA		
Design Number	234769	
Class	14-03	
1)Panasonic Corporation 1006, Oaza Kadoma-shi, Osaka 571-8501, Japan		
Date of Registration	25/02/2011	
Title	Television Receiver	
Priority NA		
Design Number	234770	
Class	11-01	
1)Hiral 320, IIIrd Floor, Ganpati Plaza, Jaipur (Rajasthan), India		
Date of Registration	25/02/2011	
Title	Bangle	
Priority NA		

Design Number	234844	
Class	09-01	
1) Lotus Beverages Private Limited S-2 & 3, Second Floor, Malik Buildcon Plaza-1, Plot No.- 2, Pocket-6, Sector-12, Dwarka, New Delhi-110075, India		
Date of Registration	01/03/2011	
Title	Bottle	
Priority NA		
Design Number	234895	
Class	11-01	
1) Yash Agarwal S/o. Dr. Nawal Kishore Agarwal 9, Laxmi Complex, M.I. Road, Jaipur (Raj.), India		
Date of Registration	03/03/2011	
Title	Earring	
Priority NA		
Design Number	220822	
Class	02-04	
1) Kanishk Gupta., Liberty House, Liberty Road, Vikaram Marg, Railway Road, Karnal (Haryana), India.		
Date of Registration	19/01/2009	
Title	Sole For Footwear	
Priority NA		



Design Number	220823	
Class	02-04	
1)Kanishk Gupta., Liberty House, Liberty Road, Vikaram Marg, Railway Road, Karnal (Haryana), India.		
Date of Registration	19/01/2009	
Title	Sole For Footwear	
Priority NA		
Design Number	220824	
Class	02-04	
1)Kanishk Gupta., Liberty House, Liberty Road, Vikaram Marg, Railway Road, Karnal (Haryana), India.		
Date of Registration	19/01/2009	
Title	Footwear	
Priority NA		
Design Number	220825	
Class	02-04	
1)Kanishk Gupta., Liberty House, Liberty Road, Vikaram Marg, Railway Road, Karnal (Haryana), India.		
Date of Registration	19/01/2009	
Title	Sole For Footwear	
Priority NA		



Design Number	220826	
Class	02-04	
1)Kanishk Gupta., Liberty House, Liberty Road, Vikaram Marg, Railway Road, Karnal (Haryana), India.		
Date of Registration	19/01/2009	
Title	Sole For Footwear	
Priority NA		

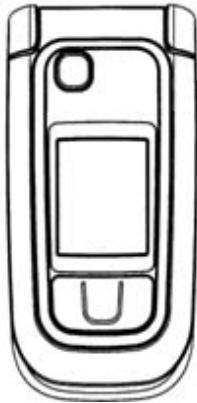

Design Number	220827	
Class	09-01	
1)Shoban Lal Jain (Huf), Shoban Lal Jain (Karta), Ashok Jain, Vikas Jain & Gaurav Jain., 17, Veer Nagar, Jain Colony, Delhi-110007, India.		
Date of Registration	19/01/2009	
Title	Bottle	
Priority NA		

Design Number	224950	
Class	08-06	
1)Italik Metalware Pvt. Ltd., G:212-215, lodhika, G.I.D.C., Kalawad Road, Metoda, Rajkot-360003 State of Gujrat India		
Date of Registration	30/09/2009	
Title	Handle	
Priority NA		

Design Number	225094	
Class	02-04	
1)Condor Footwear (India) Ltd., A- 35304, Main Road-3, Sub Road 35, Behind Dev Rekha, Sachin, Surat-394-520 the State of Gujarat		
Date of Registration	06/10/2009	
Title	Footwear	
Priority NA		
Design Number	227151	
Class	08-06	
1)Ritu Manrao V2Lights, A-44, Mangolpuri Industrial Area, Phase-II, Delhi 110034, Delhi State, India		
Date of Registration	09/02/2010	
Title	Hinge	
Priority NA		
Design Number	233642	
Class	11-02	
1)Rural Craft and Creation Pvt. Ltd., C-62, Dharam Narayan Ji Ka Hattha, Paota, Jodhpur, Rajasthan (India)		
Date of Registration	31/12/2010	
Title	Decorative Article	
Priority NA		

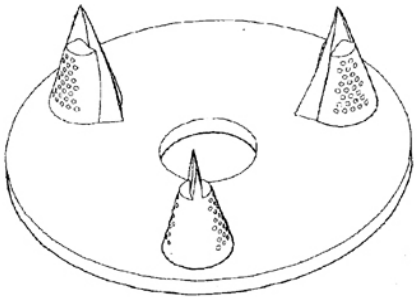
Design Number	233678		
Class	09-01		
1)Jimit Plastic 9/25, Agarwal Udyog Nagar, Sativali, Vasai (E), Thane-401208. Maharashtra, India			
Date of Registration	03/01/2011		
Title	Jar		
Priority NA			
Design Number	212508		
Class	14-03		
1)Nokia Corporation., Keilalahdentie 4, Fin-02150 Espoo, Finland.			
Date of Registration	17/09/2007		
Title	Handset		
Priority			
Priority Number	Date	Country	
29/278,284	23/03/2007	U.S.A.	
Design Number	223874		
Class	20-02		
1)Glue Design Private Limited C-51, Sector VI, Noida, Uttar Pradesh, India			
Date of Registration	17/07/2009		
Title	Product Display Unit		
Priority NA			

Design Number	225244		
Class	07-02		
1)Saeco Strategic Service Ltd. Irish Company of Unit 1E, Block 71-Park West Business Park, Nangor Road, Dublin 12, Ireland			
Date of Registration	09/10/2009		
Title	Coffee Machine		
Priority			
Priority Number	Date	Country	
001120752-0001	10/04/2009	OHIM	
Design Number	225301		
Class	08-05		
1)Robert Bosch GmbH Postfach 30 02 20, 70442 Stuttgart, Germany			
Date of Registration	13/10/2009		
Title	Impact Wrench		
Priority			
Priority Number	Date	Country	
001159792	17/08/2009	OHIM	
Design Number	226520		
Class	07-02		
1)Swiss Caffe Asia Ltd., Flat G, 10/F., Valiant Industrial center, 2-12 Au Pui Wan Street, Fo Tan, Shatin, N.T., Hong Kong			
Date of Registration	29/12/2009		
Title	Piercing Disc For Capsules Or Pods For Coffee Machines		
Priority			
Priority Number	Date	Country	
001150999	07/07/2009	OHIM	

Design Number	235566		
Class	23-04		
1)Crompton Greaves Limited., Avantha House, 6th Floor, Dr. Annie Besant Road, Worli, Mumbai-400030, Maharashtra, India			
Date of Registration	28/03/2011		
Title	Wall Fan		
Priority NA			
Design Number	221516		
Class	24-01		
1)Relaxbirth Oy., Kytösuntie 6, 00300 Hilsinki, Finland.			
Date of Registration	04/03/2009		
Title	Birthing Frame		
Priority			
Priority Number	Date	Country	
001001176	11/09/2008	OHIM	
Design Number	223571		
Class	15-99		
1)Spray Engineering Devices Limited Plot No. 25, Industrial Area, Phase-II, Chandigarh - 160 002 (U.T.), India			
Date of Registration	29/06/2009		
Title	Gasifier		
Priority NA			

Design Number	223592		
Class	29-02		
1)Johann Berger Obere Schlossstr. 114, 73553 Alfdorf, Germany			
Date of Registration	30/06/2009		
Title	Seat Belt		
Priority			
Priority Number	Date	Country	
40 2008 006 255.8	31/12/2008	Germany	

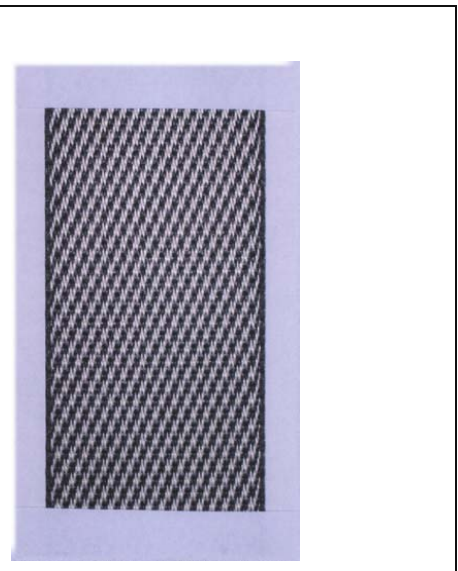



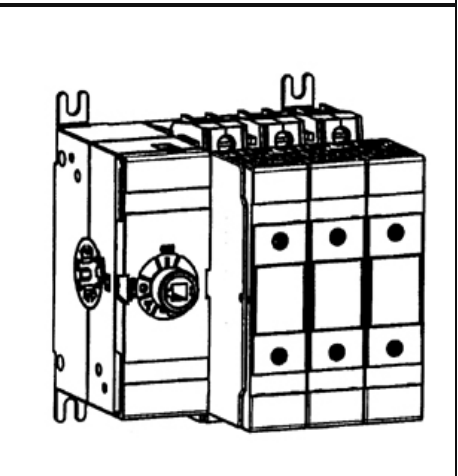

Design Number	226756		
Class	13-03		
1)Abb Oy Strombergintie 1, FI-00380 Helsinki, Finland			
Date of Registration	12/01/2010		
Title	Switch		
Priority			
Priority Number	Date	Country	
001169825	08/10/2009	OHIM	

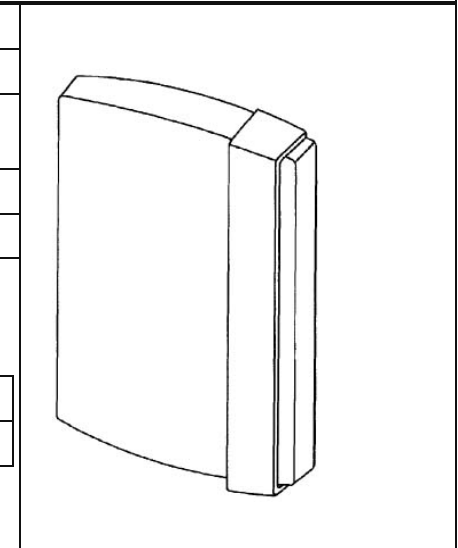

Design Number	226817		
Class	10-05		
1)Assa Abloy Hospitality, Inc. 631 International Parkway, Suite 100, Richardson, Texas 75081, U.S.A.			
Date of Registration	19/01/2010		
Title	Thermostat		
Priority			
Priority Number	Date	Country	
29/340, 788	24/07/2009	U.S.A.	

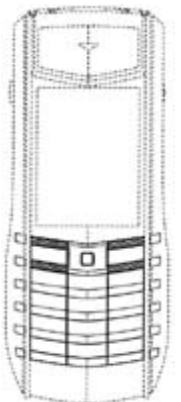
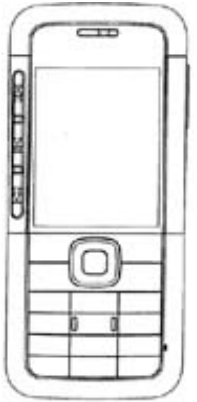

Design Number	226821	
Class	12-11	
1)Vivek Gupta 19/277, Sarai Basti, Old Rohtak Road, Delhi-110035		
Date of Registration	19/01/2010	
Title	Decorative Fittings for Spokes of Bicycles and Tricycles	
Priority NA		
Design Number	234538	
Class	09-07	
1) DD Polyplast Pvt. Ltd., "3, Pride Industrial Estate, Sativali Road, Near Waliv phata, Vasai (E) Dist. Thane-401208" Maharashtra, India		
Date of Registration	14/02/2011	
Title	Tamper Evident Screw Spout	
Priority NA		
Design Number	234540	
Class	09-07	
1)DD Polyplast Pvt Ltd., "3, Pride Industrial Estate, Sativali Road, Near Waliv phata, Vasai (E) Dist. Thane-401208" Maharashtra, India		
Date of Registration	14/02/2011	
Title	Spout Over Cap	
Priority NA		

Design Number	213868		
Class	14-03		
1)Nokia Corporation., Keilalahdentie 4, Fin-02150 Espoo, Finland.			
Date of Registration	20/12/2007		
Title	front cover for a handset		
Priority			
Priority Number	Date	Country	
29/281,278	20/06/2007	U.S.A.	
Design Number	213875		
Class	14-03		
1)Nokia Corporation., Keilalahdentie 4, Fin-02150 Espoo, Finland.			
Date of Registration	20/12/2007		
Title	key buttons for a handset		
Priority			
Priority Number	Date	Country	
29/281,278	20/06/2007	U.S.A.	
Design Number	213879		
Class	14-03		
1)Nokia Corporation., Keilalahdentie 4, Fin-02150 Espoo, Finland.			
Date of Registration	20/12/2007		
Title	Handset		
Priority			
Priority Number	Date	Country	
M20070120	20/06/2007	Finland	

Design Number	225436	
Class	08-01	
1)Robert Bosch GmbH Postfach 30 02 20, 70442 Stuttgart, Germany.		
Date of Registration	22/10/2009	
Title	Marble Saw	
Priority		
Priority Number	Date	Country
001140818	26/05/2009	OHIM

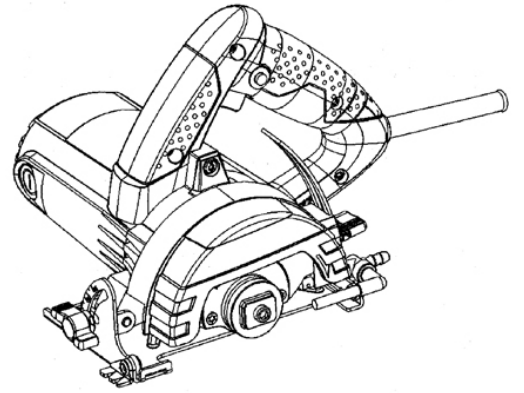

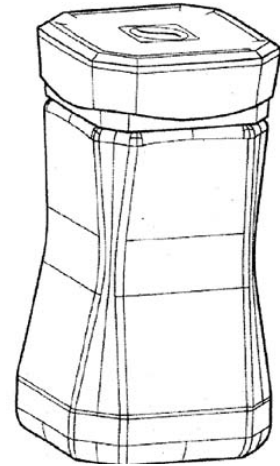

Design Number	225555	
Class	09-01	
1)Societe des Produits Nestle S.A., 1800 Vevey, Canton of Vaud, Switzerland		
Date of Registration	29/10/2009	
Title	Jar	
Priority NA		







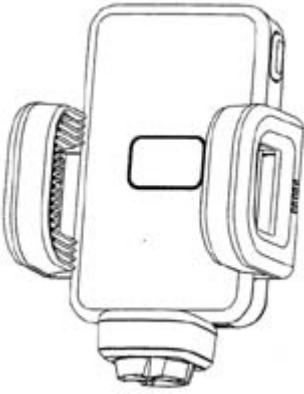

Design Number	225563	
Class	12-15	
1)Sumitomo Rubber Industries, Ltd 6-9, Wakinohama-Cho 3-Chome, Chuo-Ku, Kobe-Shi, Hyogo 651-0072, Japan		
Date of Registration	29/10/2009	
Title	Tire For Automobile	
Priority		
Priority Number	Date	Country
2009-017153	28/07/2009	Japan



Design Number	225564		
Class	12-15		
1)Sumitomo Rubber Industries, Ltd 6-9, Wakinohama-Cho 3-Chome, Chuo-Ku, Kobe-Shi, Hyogo 651-0072, Japan			
Date of Registration	29/10/2009		
Title	Tire For Automobile		
Priority			
Priority Number	Date	Country	
2009-014751	29/06/2009	Japan	
Design Number	234209		
Class	23-01		
1)Mukul Shyamsunder Taori H.I.G A/1, Housing Board Colony Raipur Naka, Durg, Chattisgarh-492013 India			
Date of Registration	01/02/2011		
Title	Rain Water Filter		
Priority NA			
Design Number	234223		
Class	02-04		
1)Alka Co., Ltd., 2-15-5, Higashi-Ikebukuro, Toshima-ku, Tokyo, 170-0013, Japan			
Date of Registration	02/02/2011		
Title	Shoe		
Priority			
Priority Number	Date	Country	
2010-018899	03/08/2010	Japan	



Design Number	234336			
Class	23-01			
1)Topland Engines Pvt. Ltd., 2, Umakant Pandit, Udyognagar, Mavdi Plot, Rajkot-360004 (Gujarat), India				
Date of Registration	09/02/2011			
Title	Hose-Pump To Engine			
Priority NA				
Design Number	236382			
Class	11-01			
1)Agni Jewels Pvt. Ltd., A-10, Nandbuvan Industrial Estate, Mahakali Caves Road, Andheri (East), Mumbai 400093, Maharashtra INDIA				
Date of Registration	28/04/2011			
Title	Pendant			
Priority NA				
Design Number	214119			
Class	14-99			
1)Nokia Corporation., Keilalahdentie 4, Fin-02150 Espoo, Finland.				
Date of Registration	04/01/2008			
Title	Holder for a Handset			
Priority				
Priority Number	Date	Country		
M20070132	04/07/2007	Finland		

Design Number	224387		
Class	26-04		
1)Wang Peicheng Room 302, No. 104, Xincum Building No. 40, Daxue Road, Shangcheng District, Hangzhou City, Zhenjiang Province, 311100, P.R. China (CN)			
Date of Registration	21/08/2009		
Title	Energy-Saving Lamp Tube		
Priority			
Priority Number	Date	Country	
200930139319.2	14/05/2009	China	
Design Number	226281		
Class	14-03		
1)Glue Design Pvt. Ltd., C-51, Sector VI, Noida-201301, Uttar Pradesh, India			
Date of Registration	16/12/2009		
Title	Mobile phone		
Priority NA			
Design Number	226362		
Class	06-01		
1)Itoki Corporation 4-12, Imafukuhigashi 1-Chome, Joto-ku, Osaka-shi, Osaka 536002, Japan			
Date of Registration	21/12/2009		
Title	Chair		
Priority NA			
			

Design Number	235060		
Class	23-01		
1)Klaus Waren Fixtures Pvt. Ltd., 285, "Park Wiew" 1st Floor, Flat No. 9, B.A.K. Anjan Marg, Opp. Napoo Garden, Matunga (Central Railway) (E), Mumbai-400019, Maharashtra, India			
Date of Registration	08/03/2011		
Title	Two Way Toilet Tap		
Priority NA			
Design Number	235140		
Class	26-01		
1)International Trade Linkers 5 B-C-D. Government Indl Estate, Hindustan Naka, Charkop, Kandivali (W), Mumbai- 400067, State of Maharashtra (India)			
Date of Registration	11/03/2011		
Title	Candle Holder		
Priority NA			
Design Number	212172		
Class	24-02		
1)Societe Pour La Conception Des Applications Des Techniques Electroniques-Satelec Avenue Gustave Eiffel-Zi Du Phare, 33700 Merignac, France.			
Date of Registration	03/09/2007		
Title	Dental Lamp		
Priority			
Priority Number	Date	Country	
000691506-0001	19/03/2007	OHIM	

Design Number	226135		
Class	15-09		
1)Mircona Ab Box 955, 801 33 Galve, Sweden			
Date of Registration	08/12/2009		
Title	Machine Tool		
Priority			
Priority Number	Date	Country	
1540584	08/06/2009	OHIM	
Design Number	230618		
Class	16-06		
1)X6D Ltd., 199 Arch Makarios III Ave 3030 Limassol Cyprus			
Date of Registration	02/08/2010		
Title	3d Glasses		
Priority			
Priority Number	Date	Country	
29/348, 752	04/02/2010	U.S.A.	
Design Number	234107		
Class	10-02		
1)Christian Dior Couture 30 AVENUE MONTAIGNE, 75008 PARIS, FRANCE			
Date of Registration	28/01/2011		
Title	Watch		
Priority			
Priority Number	Date	Country	
DM/074395	28/07/2010	WIPO	

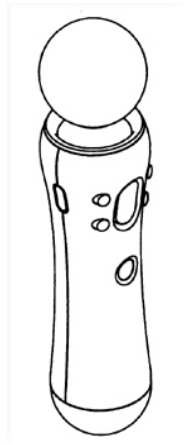
Design Number	236137		
Class	26-05		
1)Lemnis Lighting Patent Holding B.v Flevolaan 41 1411 KC Naarden			
Date of Registration	15/04/2011		
Title	Light		
Priority NA			
Design Number	236287		
Class	09-07		
1)Mitani Valve Co., LTD 7,Kanda Sakumcho 2-Chome,Chiyoda-Ku, Tokyo Japan			
Date of Registration	28/02/2011		
Title	Spray Head For Container		
Priority			
Priority Number	Date	Country	
2010-22260	15/09/2010	Japan	
Design Number	209799		
Class	09-01		
1)Schoeller Arca Systems Services GmbH Zugspitzstrabe 15, 82049-Pullach, Germany			
Date of Registration	18/04/2007		
Title	Crate		
Priority NA			

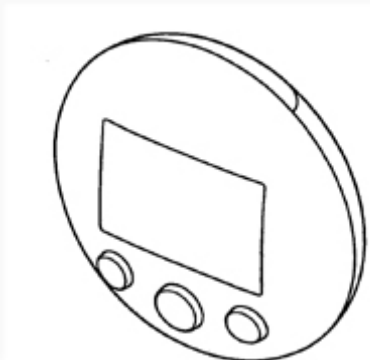
Design Number	225859		
Class	14-03		
1)Sony Computer Entertainment Inc 2-6-21, Minami-Aoyama, Minato-ku, Tokyo, Japan			
Date of Registration	19/11/2009		
Title	Remote Controller		
Priority			
Priority Number	Date	Country	
2009-11975	28/05/2009	Japan	
Design Number	225868		
Class	23-01		
1)Jain Irrigation Systems Ltd., Jain Plastic Park, NH no. 6, Bambhori, Jalgaon-425001, Maharashtra, India			
Date of Registration	20/11/2009		
Title	Sprinkler		
Priority NA			
Design Number	225870		
Class	10-04		
1)Nintendo Co., Ltd., 11-1, Hokotate-cho, Kamitoba, Minami-ku, Kyoto-shi, kyoto, Japan			
Date of Registration	20/11/2009		
Title	Pedometer		
Priority			
Priority Number	Date	Country	
2009-011682	26/05/2009	Japan	

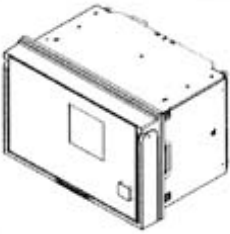
Design Number	225893		
Class	09-01		
1)Hindustan Unilever Limited Hindustan Lever House 165-166 Backbay Reclamation, Mumbai 400020, State of Maharashtra, India			
Date of Registration	25/11/2009		
Title	Bottle		
Priority			
Priority Number	Date	Country	
29/315, 266	10/06/2009	U.S.A.	
Design Number	235400		
Class	13-03		
1)ABB OY Stormbergintie 1, FI-00380 Helsinki, Finland			
Date of Registration	22/03/2011		
Title	Protective Relay		
Priority			
Priority Number	Date	Country	
001236103	23/09/2010	OHIM	