

INTRODUCTION

In view of the recent amendment made in the Designs (Amendment) Rules, 2008 with effect from 17/06/2008, Publication of the matter relating to Designs is being published in the Official Journal of The Patent Office. This Journal is being published on weekly basis on every Friday covering the various proceedings on Designs as required according to the provisions of under Rule 22, 25, 27 and 39 of the Design (Amendment) Rules, 2008. All the enquiries on this Official Journal and other information as required by the public should be addressed to the Controller General of Patents, Designs & Trade Marks. Suggestions and comments are requested from all quarters so that the content can be enriched.

COPYRIGHT PUBLICATION

SL NO	CASE NUMBERS	RENEWED ON
1.	186033	09.11.2011
2.	186035	09.11.2011
3.	186036	09.11.2011
4.	186128	09.11.2011
5.	186129	09.11.2011
6.	186130	09.11.2011
7.	186131	09.11.2011
8.	186132	09.11.2011
9.	186133	09.11.2011
10.	186134	09.11.2011
11.	187698	09.11.2011
12.	187700	09.11.2011
13.	226135	09.11.2011
14.	227290	09.11.2011
15.	227505	09.11.2011
16.	227506	09.11.2011
17.	227579	09.11.2011
18.	227580	09.11.2011
19.	228603	09.11.2011
20.	228605	09.11.2011
21.	228630	09.11.2011
22.	228631	09.11.2011
23.	232259	09.11.2011
24.	232261	09.11.2011
25.	232482	09.11.2011

CANCELLATION PROCEEDINGS
under Section 19 of the Designs Act, 2000

(01)

“The Ld. Asstt. Controller of Patents & Designs passed an order on 24/11/2011 to cancel the registration of registered Design No.196306 dated 19/7/2004 under Class 06-11 titled as ‘Carpet’ in the name of S.N. Kapoor Exports, an Indian partnership firm of Khwasji ka bagh, Amer Road, Jaipur-302002, Rajasthan (India) whose partners are Surinder Nath Kapoor and Vikram Kapoor, both are Indian of above address.”



(02)

“The Ld. Asstt. Controller of Patents & Designs passed an order on 24/11/2011 to cancel the registration of registered Design No.196307 dated 19/7/2004 under Class 06-11 titled as ‘Carpet’ in the name of S.N. Kapoor Exports, an Indian partnership firm of Khwasji ka bagh, Amer Road, Jaipur-302002, Rajasthan (India) whose partners are Surinder Nath Kapoor and Vikram Kapoor, both are Indian of above address.”

REGISTRATION OF DESIGNS

The following designs have been registered. They are now open for public inspection. In the following each entry the Date of Registration is shown. The Priority Number, Priority Date and Priority Country are also shown

Design Number	235351		
Class	13-03		
1)Federal Elektrik Yatirim Ve Ticaret Anonim Sirketi 1. Organize Sanayi Bolgesi, Hanli Bledesi Sakarya/Turkey			
Date of Registration	18/03/2011		
Title	Miniature Circuit Breaker		
Priority NA			
Design Number	232545		
Class	23-04		
1)Zobelespana, S.A., Spain, Argenters, 8-Edif. 3-Parc Technologic del Valles, 08290 Cerdanyola Del Valles, (Barcelona), Spain			
Date of Registration	09/11/2010		
Title	Air Freshener		
Priority			
Priority Number	Date	Country	
001710666-0001	21/05/2010	OHIM	
Design Number	234203		
Class	30-99		
1)Shivam Polymers B-16 Site No. B, Surajpur Industrial Area, Greater Noida, UP, India			
Date of Registration	01/02/2011		
Title	Pet Play Toy		
Priority NA			

Design Number	234435		
Class	13-03		
1)Ajanta Manufacturing Limited Ajanta Corporate House, 8A National Highway, Same Kanthe, Morbi 363642, Dist. Rajkot, State of Gujarat, India			
Date of Registration	10/02/2011		
Title	Regulator		
Priority NA			
Design Number	219107		
Class	14-01		
1)Sony Ericsson Mobile Communications AB Se-221 88, Lund, Sweden, A Swedish Company.			
Date of Registration	13/10/2008		
Title	Microphone		
Priority			
Priority Number	Date	Country	
000937198-002	20/05/2008	OHIM	
Design Number	233458		
Class	23-04		
1)Zobeles Holding S.p.A., Via Fersina 4, I-38100 Trento, Italy			
Date of Registration	22/12/2010		
Title	Volatile Substances Evaporators		
Priority			
Priority Number	Date	Country	
001723081.0001	23/06/2010	OHIM	

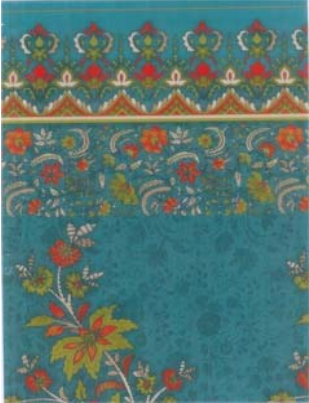
Design Number	235583	
Class	26-03	
1)Crompton Greaves Limited., Avantha House, 6th Floor, Dr. Annie Besant Road, Worli, Mumbai-400030, Maharashtra, India		
Date of Registration	28/03/2011	
Title	Lighting Fixture	
Priority NA		
Design Number	235683	
Class	05-05	
1)Biba Apparels Pvt. Ltd., 45-54, "Whitehall", Kemps Corner, 143 A.K. Marg., Mumbai-400036, Maharashtra, India		
Date of Registration	28/03/2011	
Title	Textile Fabric	
Priority NA		
Design Number	235859	
Class	26-05	
1)Crompton Greaves Limited., Avantha House, 6th Floor, Dr. Annie Besant Road, Worli, Mumbai-400030, Maharashtra, India		
Date of Registration	31/03/2011	
Title	Task Light	
Priority NA		

Design Number	212216	
Class	13-03	
1)Siemens Aktiengesellschaft Wittelsbacherplatz 2, 80333 Munchen, Germany.		
Date of Registration	05/09/2007	
Title	REVERSING STARTER	
Priority		
Priority Number	Date	Country
000690037	05/03/2007	OHIM

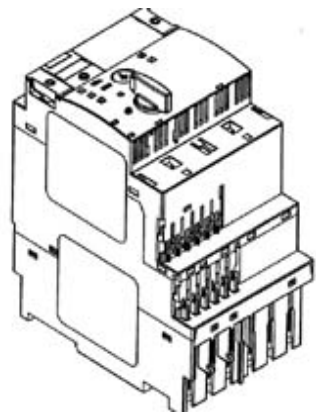



Design Number	234071	
Class	23-01	
1)Desert Eco Systems Pty Ltd, R/Off 4 Belina Street, Evandale, South Australia, 5069, Australia		
Date of Registration	25/01/2011	
Title	Plumbing Adaptor.	
Priority		
Priority Number	Date	Country
13150/2010	27/07/2010	Australia



Design Number	234125	
Class	10-05	
1)Jordan Aerospace Industries (JAI) P. O. Box 815570, Amman 11180, Jordan		
Date of Registration	31/01/2011	
Title	Equipment for Target Acquisition	
Priority NA		

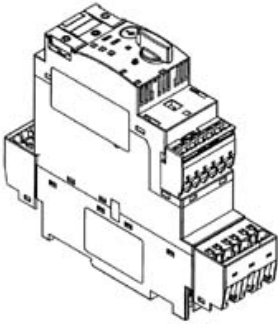

Design Number	235539	
Class	09-03	
1)Klik Plastic Art Pvt. Ltd., B-702, Vikas Palms, Dr. Ambedkar Road, Tahne West-400602, Dist. Thane, Maharashtra, India		
Date of Registration	28/03/2011	
Title	Container With Lid	
Priority NA		
Design Number	235855	
Class	26-05	
1)Crompton Greaves Limited., Avantha House, 6th Floor, Dr. Annie Besant Road, Worli, Mumbai-400030, Maharashtra, India		
Date of Registration	31/03/2011	
Title	Task Light	
Priority NA		
Design Number	235866	
Class	26-05	
1)Crompton Greaves Limited., Avantha House, 6th Floor, Dr. Annie Besant Road, Worli, Mumbai-400030, Maharashtra, India		
Date of Registration	31/03/2011	
Title	Task Light	
Priority NA		

Design Number	235876	
Class	26-03	
1)Crompton Greaves Limited., Avantha House, 6th Floor, Dr. Annie Besant Road, Worli, Mumbai-400030, Maharashtra, India		
Date of Registration	31/03/2011	
Title	Lighting Fixture	
Priority NA		
Design Number	212201	
Class	13-03	
1)Siemens Aktiengesellschaft Wittelsbacherplatz 2, 80333 Munchen, Germany.		
Date of Registration	05/09/2007	
Title	Compact Starter	
Priority NA		
Design Number	230359	
Class	24-01	
1)Vikas Scientific Industries WZ-133, Ring Road, Naraina, New Delhi-110028		
Date of Registration	20/07/2010	
Title	Hi Vaccume Laboratory Stirrer	
Priority NA		

Design Number	236130		
Class	24-04		
1)Smith & Nephew Plc 15 Adam Street, London WC2N 6LA, United Kingdom			
Date of Registration	15/04/2011		
Title	Medical Dressing		
Priority			
Priority Number	Date	Country	
4017442	15/10/2010	U.K.	
Design Number	235938		
Class	15-03		
1)Milltec Machinery Private Limited No. 51-A, 1st Pahse KIADB Indl Area, Bommasandra, Bangalore-560099, State of Karnataka, India			
Date of Registration	01/04/2011		
Title	Rice Separator		
Priority NA			
Design Number	235960		
Class	08-06		
1)Janki die-cast 4, Patel Nagar, Nr: Sorathiwadi circle Rajkot-Gujarat (India)			
Date of Registration	05/04/2011		
Title	Handle		
Priority NA			

Design Number	233549	
Class	12-09	
1)Deere & Company One John Deere Place, Moline, Illinois, 61265 USA		
Date of Registration	27/12/2010	
Title	Hood Assembly for Vehicles	
Priority		
Priority Number	Date	Country
29/378,004	28/10/2010	U.S.A.

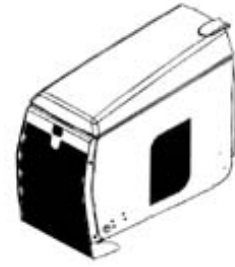





Design Number	235301	
Class	13-99	
1)Wartsila Finland Oy Tarhaajantie 2, FI-65380 Vaasa, Finland		
Date of Registration	17/03/2011	
Title	Energy Production Device	
Priority		
Priority Number	Date	Country
M20100140	27/09/2010	Finland





Design Number	206764	
Class	23-02	
1)Ophardt Hygiene-Technik Gmbh & Co. Kg Lindenau 27, 47661 Issum, Germany.		
Date of Registration	26/10/2006	
Title	Litter Receptacle	
Priority		
Priority Number	Date	Country
000520499	26/04/2006	OHIM

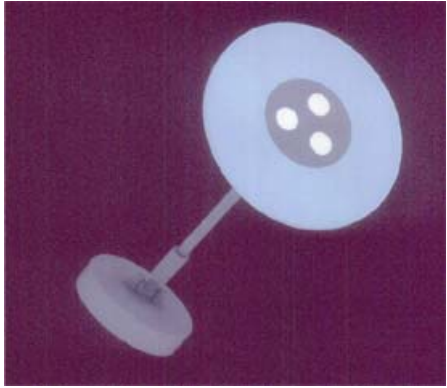
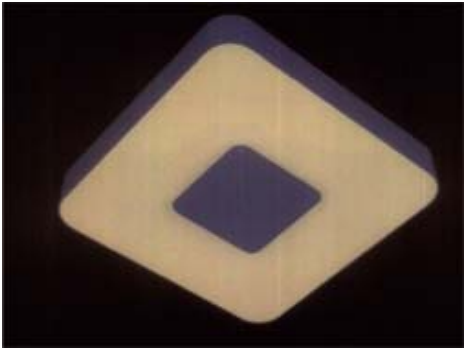

Design Number	236671	
Class	08-07	
1)Godrej & Boyce Mfg. Co. Ltd., Locks Division (Plant-18), Pirojshnagar, Vikhroli, Mumbai-400079, Maharashtra, India		
Date of Registration	12/05/2011	
Title	Rolling Shutter Padlock.	
Priority NA		
Design Number	235132	
Class	12-16	
1)Tata Motors Limited Bombay House, 24 Homi Mody Street, Hutatma Chowk, Mumbai 400001, Maharashtra, India		
Date of Registration	11/03/2011	
Title	Wheel Rim Cover For Vehicle	
Priority NA		
Design Number	235150	
Class	09-01	
1)Marico Limited Rang Sharda, K.C. Marg, Bandra Reclamation, Bandra West, Mumbai-400050 (India)		
Date of Registration	11/03/2011	
Title	Bottle	
Priority NA		

Design Number	233747	
Class	23-01	
1)Krona Liquatec Ltd., H-27, 1st Floor, Bali Nagar, New Delhi-110015, India		
Date of Registration	06/01/2011	
Title	Inline Filter For Water Purification System	
Priority NA		
Design Number	233910	
Class	08-06	
1)Oswal Hardware 107, Keshavji Nayak Road, Hingwala Bldg., Room No. 43/44, 4th Floor, Masjid Bunder, Mumbai-400009., India		
Date of Registration	14/01/2011	
Title	Handle	
Priority NA		
Design Number	235765	
Class	23-02	
1)HSIL Limited Bahadurgarh, 124507, Dt: Jhajjar, Haryana, India		
Date of Registration	29/03/2011	
Title	Pan	
Priority NA		

Design Number	235820	
Class	13-03	
1)Crompton Greaves Limited., Avantha House, 6th Floor, Dr. Annie Besant Road, Worli, Mumbai-400030, Maharashtra, India		
Date of Registration	31/03/2011	
Title	Vacuum Circuit Breaker	
Priority NA		
Design Number	235864	
Class	26-05	
1)Crompton Greaves Limited., Avantha House, 6th Floor, Dr. Annie Besant Road, Worli, Mumbai-400030, Maharashtra, India		
Date of Registration	31/03/2011	
Title	Task Light	
Priority NA		
Design Number	235874	
Class	26-03	
1)Crompton Greaves Limited., Avantha House, 6th Floor, Dr. Annie Besant Road, Worli, Mumbai-400030, Maharashtra, India		
Date of Registration	31/03/2011	
Title	Lighting Fixture	
Priority NA		



Design Number	236159	
Class	23-01	
1)Kanan Plast 7,Anukul Ind Estate Near National Water Tank Ambica Nagar Road G.I.D.C Odhav, Ahmedabad- 382415 Gujrat		
Date of Registration	18/04/2011	
Title	Fluid Distribution Equipment	
Priority NA		

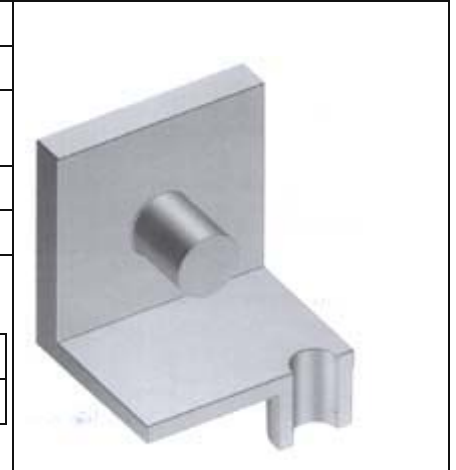

Design Number	217991	
Class	23-02	
1)Hansgrohe Ag. Auestr. 5-9, D-77761 Schiltach Germany.		
Date of Registration	21/08/2008	
Title	Sanitary Fitting	
Priority		
Priority Number	Date	Country
000887740	27/02/2008	OHIM

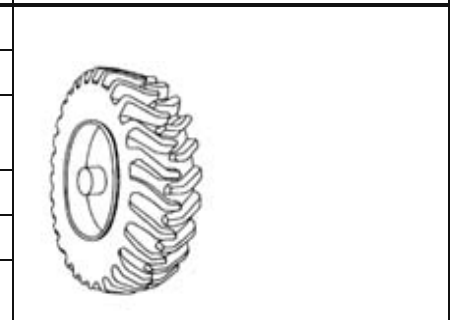



Design Number	235249	
Class	12-15	
1)Titan International Inc., 2701 Spruce Street, Quincy IL, 62301, The United States of America		
Date of Registration	15/03/2011	
Title	Tyre	
Priority NA		



Design Number	234198	
Class	09-01	
1)Bangalore Soft Drink Pvt. Ltd., 7th Mile, Mysore Road, Bangalore-560039, Karnataka, India		
Date of Registration	01/02/2011	
Title	Bottle	
Priority NA		
Design Number	234243	
Class	20-01	
1)Scrum Systems Pvt. Ltd., 402 Swojas 87/6/A, Law College Road, Pune-411004, Maharashtra, India		
Date of Registration	03/02/2011	
Title	Kiosk	
Priority NA		
Design Number	234431	
Class	13-03	
1)Ajanta Manufacturing Limited Ajanta Corporate House, 8A National Highway, Same Kanthe, Morbi 363642, Dist. Rajkot, State of Gujarat, India		
Date of Registration	10/02/2011	
Title	Telephone Socket	
Priority NA		

Design Number	235540	
Class	09-03	
1)Klik Plastic Art Pvt. Ltd., B-702, Vikas Palms, Dr. Ambedkar Road, Tahne West-400602, Dist. Thane, Maharashtra, India		
Date of Registration	28/03/2011	
Title	Container With Lid	
Priority NA		
Design Number	235672	
Class	05-05	
1)Biba Apparels Pvt. Ltd., 45-54, "Whitehall", Kemps Corner, 143 A.K. Marg., Mumbai-400036, Maharashtra, India.		
Date of Registration	28/03/2011	
Title	Textile Fabric	
Priority NA		
Design Number	235756	
Class	23-04	
1)Dyson Limited Tetbury Hill, Malmesbury, Wiltshire, SN16 0RP, United Kingdom		
Date of Registration	28/03/2011	
Title	Bladeless Fan	
Priority NA		

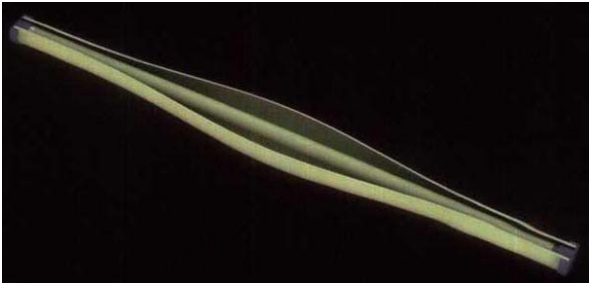

Design Number	235825	
Class	26-03	
1)Crompton Greaves Limited., Avantha House, 6th Floor, Dr. Annie Besant Road, Worli, Mumbai-400030, Maharashtra, India		
Date of Registration	31/03/2011	
Title	Lighting Fixture	
Priority NA		
Design Number	235843	
Class	10-05	
1)Crompton Greaves Limited., Avantha House, 6th Floor, Dr. Annie Besant Road, Worli, Mumbai-400030, Maharashtra, India		
Date of Registration	31/03/2011	
Title	Surge Arrester	
Priority NA		
Design Number	237740	
Class	07-01	
1)Ma Design India Private Limited A-41, Sector-80, Phase-II, Noida-201305, U.P. India.,		
Date of Registration	04/07/2011	
Title	Cup	
Priority NA		



Design Number	235762	
Class	23-02	
1)HSIL Limited Bahadurgarh, 124507, Dt: Jhajjar, Haryana, India		
Date of Registration	29/03/2011	
Title	Urinal	
Priority NA		
Design Number	235781	
Class	23-02	
1)Anchor Sanitaryware Pvt. Ltd., Ternetar Road, Thangadh-363530, Gujarat, India		
Date of Registration	29/03/2011	
Title	Commode With Flush Tank	
Priority NA		
Design Number	235872	
Class	26-03	
1)Crompton Greaves Limited., Avantha House, 6th Floor, Dr. Annie Besant Road, Worli, Mumbai-400030, Maharashtra, India		
Date of Registration	31/03/2011	
Title	Lighting Fixture	
Priority NA		

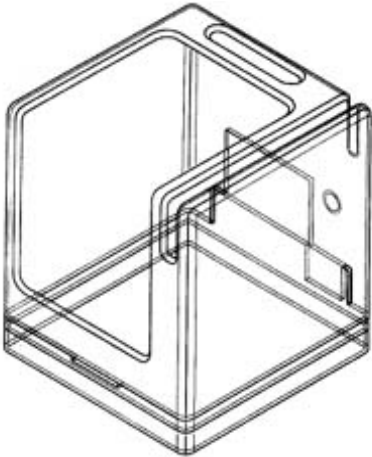

Design Number	237818	
Class	23-01	
1)Grand Industries D-72, Phase-5, Focal Point, Ludhiana-141010 (Punjab) India		
Date of Registration	05/07/2011	
Title	Hose Pipe	
Priority NA		
Design Number	236649	
Class	13-02	
1)Su-Kam Power Systems Ltd., Plot No. WZ-1401/2, Nangal Raya, New Delhi-110046, India		
Date of Registration	11/05/2011	
Title	Digital Home Ups	
Priority NA		
Design Number	235124	
Class	23-01	
1)klaus Waren Fixtures Pvt. Ltd. 285 Park View 1St floor Flat No 9 B.A.K Anjan Marg OPP Napoo Garden Matunga(Central Railway)(E) Mumbai 400019 Maharashtra India		
Date of Registration	10/03/2011	
Title	Basin Faucet Body	
Priority NA		

Design Number	235698	
Class	05-05	
1)Biba Apparels Pvt. Ltd., 45-54, "Whitehall", Kemp's Corner, 143 A.K. Marg., Mumbai-400036, Maharashtra, India		
Date of Registration	28/03/2011	
Title	Textile Fabric	
Priority NA		
Design Number	235764	
Class	23-02	
1)HSIL Limited Bahadurgarh, 124507, Dt: Jhajjar, Haryana, India		
Date of Registration	29/03/2011	
Title	Water Closet	
Priority NA		
Design Number	235837	
Class	26-05	
1)Crompton Greaves Limited., Avantha House, 6th Floor, Dr. Annie Besant Road, Worli, Mumbai-400030, Maharashtra, India		
Date of Registration	31/03/2011	
Title	End cap for Lighting Fixture	
Priority NA		

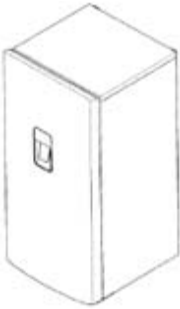
Design Number	235873	
Class	26-03	
1)Crompton Greaves Limited., Avantha House, 6th Floor, Dr. Annie Besant Road, Worli, Mumbai-400030, Maharashtra, India		
Date of Registration	31/03/2011	
Title	Lighting Fixture	
Priority NA		
Design Number	234534	
Class	03-01	
1)Hema. V.S. (Indian), Proprietrix of M/s LAKSHMI PLASTICS P. O. Choolissery, Narayanathara, Trichur-680541, Kerala, India		
Date of Registration	14/02/2011	
Title	Safety Box For Tooth Paste, Tooth Brush And Tongue Cleaner	
Priority NA		
Design Number	237045	
Class	16-06	
1)A Royal Co. 7/2902, Laxminarayan Bhuvan Saiyed Pura Nani Kadiya Street Behind Sahajanand Lasser, Surat Gujrat India		
Date of Registration	02/06/2011	
Title	Base Of Microscope	
Priority NA		

Design Number	234300	
Class	14-99	
1)PointPay International AG Industrietrasse 8, 6300 Zug, Switzerland		
Date of Registration	07/02/2011	
Title	Cover For A Point of Sale Terminal	
Priority NA		
Design Number	236615	
Class	15-03	
1)S. Harpreet Singh Bains V.P.O, Rawalpindi, Hoshiarpur Road, Tehsil-Phagwara, Dist. Kapurthala (Punjab), India		
Date of Registration	10/05/2011	
Title	Four Wheel Driven Harvester Combine	
Priority NA		
Design Number	235138	
Class	19-06	
1)Parker Pen Products Halifax Avenue, Fradley Park, Lichfield, Staffordshire, WS 13 8SS, United Kingdom		
Date of Registration	11/03/2011	
Title	Writing Instrument	
Priority NA		

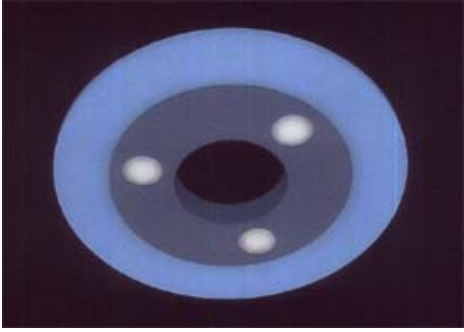
Design Number	236731		
Class	15-07		
1)Samsung Electronics Co. Ltd. 416, Maetan-Dong, Yeongtong-Gu, Suwon-Si , Gyeonggi-Do republic Of Korea			
Date of Registration	18/05/2011		
Title	Refrigerator.		
Priority NA			
Design Number	215668		
Class	13-03		
1)Siemens Aktiengesellschaft., Wittelsbacherplatz 2, 80333 Munchen, Germany.			
Date of Registration	31/03/2008		
Title	Contractor		
Priority			
Priority Number	Date	Country	
DE 40705127.9	01/10/2007	OHIM	
Design Number	237997		
Class	06-11		
1)M/s. S. N. Kapoor Export Khawasji Ka Bagh, Amer Road, Jaipur-302002 (Raj) India			
Date of Registration	12/07/2011		
Title	Carpet		
Priority NA			

Design Number	235826	
Class	26-05	
1)Crompton Greaves Limited., Avantha House, 6th Floor, Dr. Annie Besant Road, Worli, Mumbai-400030, Maharashtra, India		
Date of Registration	31/03/2011	
Title	Lighting Reflectors	
Priority NA		
Design Number	235868	
Class	26-03	
1)Crompton Greaves Limited., Avantha House, 6th Floor, Dr. Annie Besant Road, Worli, Mumbai-400030, Maharashtra, India		
Date of Registration	31/03/2011	
Title	Lighting Fixture	
Priority NA		
Design Number	234597	
Class	09-01	
1)Bharat Cottage Industries 1st Floor, vakil Industrial Estate, Walbhat Road, Goregaon (E), Mumbai-400063, Maharashtra, India		
Date of Registration	17/02/2011	
Title	Water Dispenser.	
Priority NA		

Design Number	234070	
Class	23-01	
1)Desert Eco Systems Pty Ltd, R/Off 4 Belina Street, Evandale, South Australia, 5069, Australia		
Date of Registration	25/01/2011	
Title	Plumbing Trap Assembly.	
Priority		
Priority Number	Date	Country
13149/2010	27/07/2010	Australia







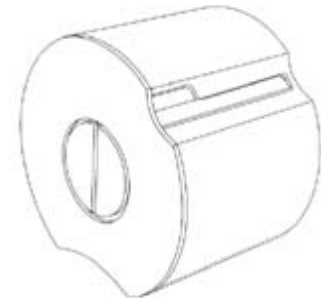

Design Number	237429	
Class	15-03	
1)BCS India Private Limited Vill. Manngarh, Kohara Machiwara Road, P.O. Kohar-141112, Punjab, India.		
Date of Registration	21/06/2011	
Title	Power Operated Weeder	
Priority NA		

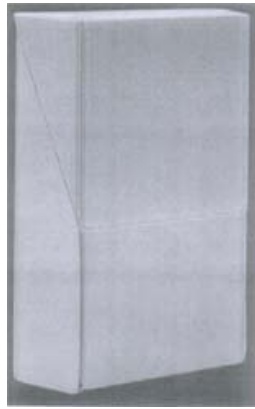

Design Number	233532	
Class	09-03	
1)Wm. Wrigley Jr. Company 410 North Michigan Avenue, Chicago, Illinois, 60611, USA		
Date of Registration	24/12/2010	
Title	Dispenser	
Priority		
Priority Number	Date	Country
US 29/364, 571	25/06/2010	U.S.A.

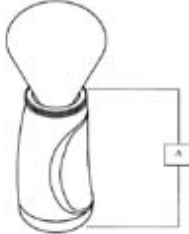

Design Number	233705		
Class	09-03		
1)ITC Limited Virginia House, 37, J.L. Nehru Road, Kolkata 700071, West Bengal, India			
Date of Registration	04/01/2011		
Title	Cigarette Pack		
Priority NA			
Design Number	206765		
Class	23-02		
1)Ophardt hygiene-Technik Gmbh & Co. Kg Lindenau 27, 47661 Issum, Germany.			
Date of Registration	26/10/2006		
Title	Soap Dispenser		
Priority			
Priority Number	Date	Country	
000520499	26/04/2006	OHIM	
Design Number	234233		
Class	25-99		
1)Pentagon Steels India Private Limited 15/216, Second Floor, Mohite Paradise, Sinhgad road, Manikbaug, Pune-411051, Maharashtra, India			
Date of Registration	02/02/2011		
Title	Roofing Sheet		
Priority NA			

Design Number	234279		
Class	06-08		
1)Mainetti (UK) Limited Scotland of Annfield Estate, Oxnam Road, Jedburgh, Roxburghshire, Scotland, TD8 6NN, United Kingdom			
Date of Registration	04/02/2011		
Title	Garment Hanger		
Priority			
Priority Number	Date	Country	
4016523	05/08/2010	U.K.	
Design Number	236711		
Class	28-03		
1)The Gillette Company IP/ Legal Patent Department - 3E, One Gillette Park ,Boston, 02127, United State America			
Date of Registration	16/05/2011		
Title	Shaving Brush		
Priority			
Priority Number	Date	Country	
29/379,271	17/11/2010	U.S.A.	
Design Number	235135		
Class	19-06		
1)Parker Pen Products Halifax Avenue, Fradley Park, Lichfield, Staffordshire, WS 13 8SS, United Kingdom			
Date of Registration	11/03/2011		
Title	Writing Instrument		
Priority NA			

Design Number	234820	
Class	24-02	
1)Koninklijke Philips Electronics N.V., Groenewoudseweg 1, 5621 Ba Eindhoven, The Netherlands		
Date of Registration	28/02/2011	
Title	Cartridge for Point-of-Care Diagnostics	
Priority		
Priority Number	Date	Country
001748708-0001	31/08/2010	OHIM



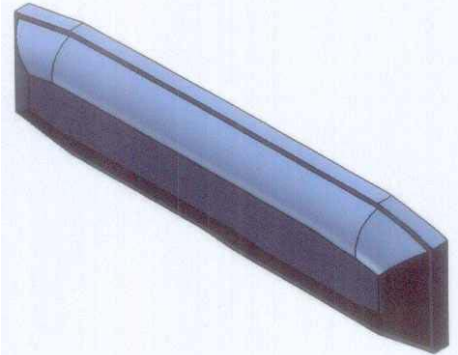

Design Number	235821	
Class	26-05	
1)Crompton Greaves Limited., Avantha House, 6th Floor, Dr. Annie Besant Road, Worli, Mumbai-400030, Maharashtra, India		
Date of Registration	31/03/2011	
Title	End Cap for Lighting Fixture	
Priority NA		



Design Number	235839	
Class	13-03	
1)Crompton Greaves Limited., Avantha House, 6th Floor, Dr. Annie Besant Road, Worli, Mumbai-400030, Maharashtra, India		
Date of Registration	31/03/2011	
Title	Vacuum Interrupter	
Priority NA		



Design Number	235853	
Class	26-05	
1)Crompton Greaves Limited., Avantha House, 6th Floor, Dr. Annie Besant Road, Worli, Mumbai-400030, Maharashtra, India		
Date of Registration	31/03/2011	
Title	Task Light	
Priority NA		

Design Number	236129	
Class	24-04	
1)Smith & Nephew Plc 15 Adam Street, London WC2N 6LA, United Kingdom		
Date of Registration	15/04/2011	
Title	Medical Dressing	
Priority		
Priority Number	Date	
4017443	15/10/2010	U.K.