

INTRODUCTION

In view of the recent amendment made in the Designs (Amendment) Rules, 2008 with effect from 17/06/2008, Publication of the matter relating to Designs is being published in the Official Journal of The Patent Office. This Journal is being published on weekly basis on every Friday covering the various proceedings on Designs as required according to the provisions of under Rule 22, 25, 27 and 39 of the Design (Amendment) Rules, 2008. All the enquiries on this Official Journal and other information as required by the public should be addressed to the Controller General of Patents, Designs & Trade Marks. Suggestions and comments are requested from all quarters so that the content can be enriched.

DESIGN
CORRIGENDUM

The Registered Design No. 246272 which has been erroneously published in the official Journal of India dated 08/03/2013, part –II , at page 5775, column 3 in the name of COLGATE-PALMOLIVE COMPANY, A DELAWARE CORPORATION, 300 PARK AVENUE, NEW YORK, NEW YORK 10022, USA OMRON HEALTHCARE CO., LTD., A JAPANESE CORPORATION, 53, KUNOTSUBO, TERADO-CHO, MUKO-SHI, KYOTO 617-0002, JAPAN Class 04-02, Date of Registration 28/06/2012, Titled as BRUSH HEAD FOR ELECTRIC TOOTHBRUSH, Priority Number 2011305109280.1, Date 28/12/2011, Country CHINA should read as COLGATE-PALMOLIVE COMPANY, A DELAWARE CORPORATION, 300 PARK AVENUE, NEW YORK, NEW YORK 10022, USA OMRON HEALTHCARE CO., LTD., A JAPANESE CORPORATION, 53, KUNOTSUBO, TERADO-CHO, MUKO-SHI, KYOTO 617-0002, JAPAN Class 04-02, Date of Registration 28/06/2012, Titled as BRUSH HEAD FOR ELECTRIC TOOTHBRUSH, Priority Number 201130510928.1, Date 28/12/2011, Country CHINA

COPYRIGHT PUBLICATION

SL NO	CASE NUMBERS	RENEWED ON
1.	187325	08.01.2013
2.	191672	14.03.2013
3.	191673	14.03.2013
4.	191674	14.03.2013
5.	191675	14.03.2013
6.	191676	14.03.2013
7.	191677	14.03.2013
8.	191678	14.03.2013
9.	191679	14.03.2013
10.	191680	14.03.2013



THE DESIGNS ACT 2000
SECTION 30
DESIGN ASSIGNMENT

The Design stands in the name of **K. V. INTERNATIONAL** registered under the Designs Act, 2000 has been assigned in the Register of Designs in the name as follows:-

Design No.	Class	Name
234102	09-03	KAVITA ARORA, AN INDIAN NATIONAL TRADING AS RADIANCE CHEMICALS, AN INDIAN PROPRIETORSHIP FIRM OF 263, B.B. GANGULY STREET, KOLKATA-700012, WEST BENGAL, INDIA

REGISTRATION OF DESIGNS

The following designs have been registered. They are now open for public inspection. In the following each entry the Date of Registration is shown. The Priority Number, Priority Date and Priority Country are also shown

DESIGN NUMBER	246009		
CLASS	23-03		
1)SPIRAX MARSHALL PVT. LTD., A COMPANY INCORPORATED UNDER THE INDIAN COMPANIES ACT, AT MUMBAI-PUNE ROAD, KASARWADI, PUNE-411 034, MAHARASHTRA, INDIA.			
DATE OF REGISTRATION	18/06/2012		
TITLE	HIGH PRESSURE STEAM TRAP		
PRIORITY NA			
DESIGN NUMBER	248889		
CLASS	28-03		
1)PRAKASH KR. KOTHARI TRADING AS SUBHLAXMI PLASTIC INDUSTRIES OF PHASE-II, NO.-64, BADLI INDUSTRIAL AREA, SAMEPUR BADLI, DELHI-110042. INDIA, AN INDIAN OF THE ABOVE ADDRESS			
DATE OF REGISTRATION	19/10/2012		
TITLE	COMB		
PRIORITY NA			
DESIGN NUMBER	224377		
CLASS	23-02		
1)HANSA METALLWERKE AG SIGMARINGER STR. 107, D-70567 STUTTGART, GERMANY			
DATE OF REGISTRATION	21/08/2009		
TITLE	SANITARY INSTALLATION		
PRIORITY			
PRIORITY NUMBER	DATE	COUNTRY	
001100820-0003	06/03/2009	EUROPEAN UNION	

DESIGN NUMBER	245642	
CLASS	21-01	
1)AUDI AG, OF 85045 INGOLSTADT, GERMANY		
DATE OF REGISTRATION	30/05/2012	
TITLE	MODEL CAR	
PRIORITY		
PRIORITY NUMBER	DATE	COUNTRY
001955956-0001	01/12/2011	OHIM





DESIGN NUMBER	248506	
CLASS	15-07	
1)WHIRLPOOL OF INDIA LIMITED, AN INDIAN COMPANY HAVING ITS CORPORATE OFFICE AT WHIRLPOOL HOUSE , PLOT NO. 40, SECTOR-44, GURGAON- 122002, HARYANA, INDIA		
DATE OF REGISTRATION	08/10/2012	
TITLE	HORIZONTAL REFRIGERATOR	
PRIORITY NA		

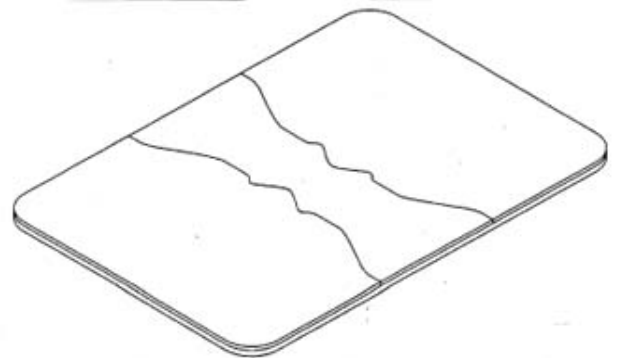

DESIGN NUMBER	247559	
CLASS	24-04	
1)TEIKOKU SEIYAKU CO., LTD., 567, SANBONMATSU, HIGASHIKAGAWA-SHI, KAGAWA 7692695, JAPAN, A JAPANESE COMPANY		
DATE OF REGISTRATION	31/08/2012	
TITLE	ADHESIVE SKIN PATCH	
PRIORITY		
PRIORITY NUMBER	DATE	COUNTRY
2012-004689	02/03/2012	JAPAN

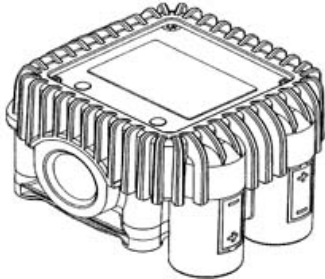
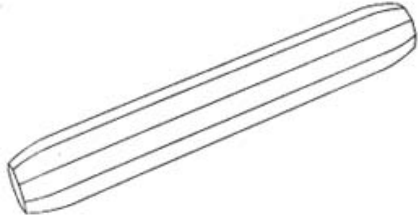

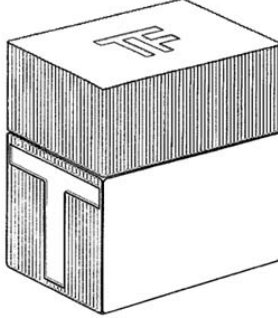

DESIGN NUMBER	247610		
CLASS	12-11		
1)HONDA MOTOR CO., LTD., A JAPANESE CORPORATION, OF 1-1, MINAMI-AOYAMA 2-CHOME, MINATO-KU, TOKYO, JAPAN			
DATE OF REGISTRATION	04/09/2012		
TITLE	REAR COVER FOR MOTORCYCLE		
PRIORITY			
PRIORITY NUMBER	DATE	COUNTRY	
2012-005265	08/03/2012	JAPAN	
DESIGN NUMBER	247628		
CLASS	10-04		
1)PIUSI S.P.A., OF VIA PACINOTTI 16/A- Z. I. RANGAVINO 46029, SUZZARA- ITALY, AN ITALIAN JOINT STOCK COMPANY			
DATE OF REGISTRATION	04/09/2012		
TITLE	MEASURING APPARATUS		
PRIORITY			
PRIORITY NUMBER	DATE	COUNTRY	
002004580	07/03/2012	OHIM	
DESIGN NUMBER	245445		
CLASS	27-99		
1)PHILIPS MORRIS PRODUCTS S.A., QUAI JEANRENAUD 3, 2000 NEUCHATEL, SWITZERLAND			
DATE OF REGISTRATION	21/05/2012		
TITLE	SMOKERS ACCESSORIES		
PRIORITY			
PRIORITY NUMBER	DATE	COUNTRY	
001303150-0002	21/11/2011	OHIM	

DESIGN NUMBER	245581		
CLASS	09-03		
1)M/S. RAKKISHANTHA EXIM PVT. LTD, COMPANY INCORPORATED UNDER INDIAN COMPANIES ACT 1956 REPRESENTED BY ITS DIRECTORS MR. M. V. KARTHIKVEL AND MRS. K. GANDHIMATHI, HAVING THE PLACE OF BUSINESS AT NEW NO. 17(OLD NO 8), 2ND FLOOR, MAHALAKSHMI STREET, T-NAGAR, CHENNAI-600017, TAMILNADU, INDIA			
DATE OF REGISTRATION	25/05/2012		
TITLE	PACKAGING FOR INCENSE STICK		
PRIORITY NA			
DESIGN NUMBER	238447		
CLASS	09-01		
1)AGRO TECH FOODS LIMITED 31, SAROJINI DEVI ROAD, SECUNDERABAD-500003 ANDHRA PRADESH INDIA.			
DATE OF REGISTRATION	01/08/2011		
TITLE	BOTTLE		
PRIORITY NA			
DESIGN NUMBER	245976		
CLASS	09-01		
1)THOMAS C. FORD, A CITIZEN OF U.S.A., C/O SHAPIRO & COMPANY, C.P.A., 9229 SUNSET BLVD., SUITE 607, LOS ANGELES, CA 90069, USA			
DATE OF REGISTRATION	14/06/2012		
TITLE	FRAGRANCE BOTTLE WITH CAP		
PRIORITY			
PRIORITY NUMBER	DATE	COUNTRY	
29/408,565	14/12/2011	U.S.A.	

DESIGN NUMBER	245999	
CLASS	13-03	
1)MR. SAURAV AGARWAL (AN INDIAN NATIONAL), S/O SHRI PRABHU DAYAL AGARWAL, A-62, MAY FAIR GARDENS, NEW DELHI-110016, (INDIA)		
DATE OF REGISTRATION	18/06/2012	
TITLE	ELECTRIC SWITCH	
PRIORITY NA		



DESIGN NUMBER	246128	
CLASS	08-05	
1)EDUARD WILLE GMBH & CO. KG, LINDENALLEE 27, 42349 WUPPERTAL, GERMANY		
DATE OF REGISTRATION	22/06/2012	
TITLE	TROQUE WRENCH	
PRIORITY		
PRIORITY NUMBER	DATE	COUNTRY
001967233-0003	22/12/2011	OHIM

DESIGN NUMBER	248866	
CLASS	08-06	
1)(1) MITESHBHAI B. PIPALIYA (2) HITESHBHAI M. PIPALIYA (3) JIGNESHBHAI B. HIRAPARA ALL INDIAN NATIONAL PARTNERS OF PATEL DIE CASTING AN INDIAN PARTNERSHIP FIRM HAVING ITS PRINCIPAL PLACE OF BUSINESS AT PATELNAGAR-4, OPP. SATYANARAYAN MILL, 80 FEET MAIN ROAD, RAJKOT, GUJARAT-INDIA		
DATE OF REGISTRATION	19/10/2012	
TITLE	HANDLE	
PRIORITY NA		

DESIGN NUMBER	248901	
CLASS	07-01	
1)RAVISSANT PRIVATE LIMITED, AN INDIAN COMPANY, OF 50-51, COMMERCIAL COMPLEX, NEW FRIENDS COLONY, NEW DELHI-110065, INDIA		
DATE OF REGISTRATION	19/10/2012	
TITLE	TEA POT	
PRIORITY NA		

DESIGN NUMBER	237351	
CLASS	12-11	
1)SUZHOU EAGLE ELECTRIC VEHICLE MANUFACTURING CO., LTD., NO. 699 TONG YUAN ROAD, SUZHOU INDUSTRIAL PARK, SUZHOU CITY		
DATE OF REGISTRATION	16/06/2011	
TITLE	ELECTRIC VEHICLE	
PRIORITY		
PRIORITY NUMBER	DATE	COUNTRY
2011300033268.2	03/03/2011	CHINA

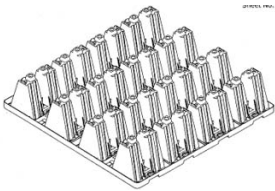
DESIGN NUMBER	246318	
CLASS	09-03	
1)M/S LNP PACKAGING OLD NO. 347/3, NEW NO. 1/401, ARCOT ROAD, SIRAKALATHUR, KUNDRATHUR, CHENNAI-600069, INDIA		
DATE OF REGISTRATION	03/07/2012	
TITLE	BOX	
PRIORITY NA		

DESIGN NUMBER	246579		
CLASS	23-01		
1)SEKISUI TECHNO MOLDING CO., LTD., A CORPORATION ORGANIZED AND EXISTING UNDER THE LAWS OF JAPAN OF 2-3-7, TORANOMON, MINATO-KU, TOKYO 105-8450, JAPAN			
DATE OF REGISTRATION	18/07/2012		
TITLE	MEMBER OF WATER STORAGE TANK		
PRIORITY			
PRIORITY NUMBER	DATE	COUNTRY	
2012-005826	14/03/2012	JAPAN	
DESIGN NUMBER	248535		
CLASS	23-01		
1)PRAKASHBHAI D. JARSANIYA., INDIAN NATIONALITY, SOLE PROPRIETOR OF M/S. ASHOK POLYMERS, INDIAN NATIONALITY, HAVING ADDRESS AT 4, SHREENATHJI ESTATE, NR. G.V.M.M., B/H. DEVBHUMI ESTATE, SINGARVA ROAD, ODHAV, AHMEDABAD-382430, GUJARAT STATE, INDIA			
DATE OF REGISTRATION	04/10/2012		
TITLE	FOOT VALVE		
PRIORITY NA			
DESIGN NUMBER	242549		
CLASS	24-02		
1)EPPENDORF AG BARKHAUSENWEG 1, 22339 HAMBURG, GERMANY			
DATE OF REGISTRATION	25/01/2012		
TITLE	AN EXCHANGEABLE TIP FOR PIPETTE		
PRIORITY			
PRIORITY NUMBER	DATE	COUNTRY	
40 2011 006 821.4	22/12/2011	GERMANY	

DESIGN NUMBER	244093	
CLASS	15-04	
1)BRADKEN RESOURCES PTY LIMITED 2 MAUD STREET, MAYFIELD WEST, NEW SOUTH WALES 2304, AUSTRALIA		
DATE OF REGISTRATION	23/03/2012	
TITLE	EXCAVATION BUCKET	
PRIORITY		
PRIORITY NUMBER	DATE	COUNTRY
14342/2011	27/09/2011	AUSTRALIA

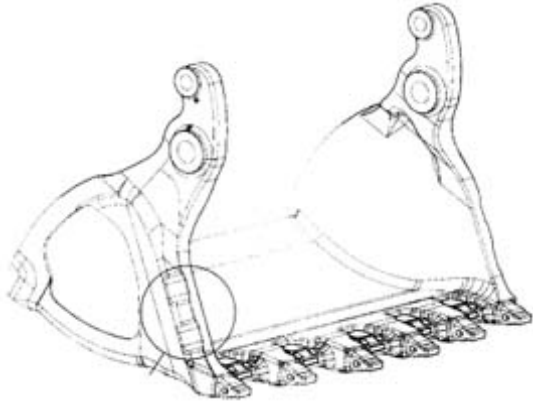

DESIGN NUMBER	236692	
CLASS	12-16	
1)SCANIA CV AB., SE-15187 SODERTALJE, SWEDEN		
DATE OF REGISTRATION	13/05/2011	
TITLE	PROTECTION PLATE FOR VEHICLE	
PRIORITY		
PRIORITY NUMBER	DATE	COUNTRY
2010/0517	15/11/2010	SWEDEN

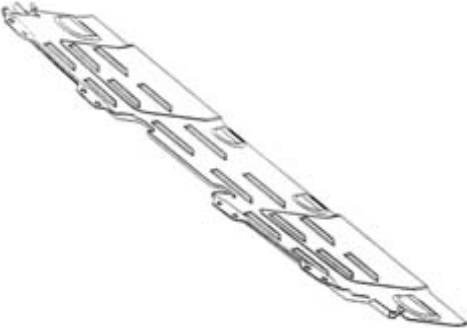

DESIGN NUMBER	241039	
CLASS	23-04	
1)FABER S.P.A., VIALE XIII LUGLIO, 160, 60044 FABRIANO (AN), ITALY		
DATE OF REGISTRATION	25/11/2011	
TITLE	KITCHEN HOOD	
PRIORITY		
PRIORITY NUMBER	DATE	COUNTRY
DM/076 199	30/05/2011	WIPO



DESIGN NUMBER	246127	
CLASS	08-05	
1)EDUARD WILLE GMBH & CO. KG, LINDENALLEE 27, 42349 WUPPERTAL, GERMANY		
DATE OF REGISTRATION	22/06/2012	
TITLE	TROQUE WRENCH	
PRIORITY		
PRIORITY NUMBER	DATE	COUNTRY
001967233-0002	22/12/2011	OHIM



DESIGN NUMBER	246163	
CLASS	12-08	
1)TOYOTA JIDOSHA KABUSHIKI KAISHA, A JAPANESE CO., OF 1, TOYOTA-CHO, TOYOTA-SHI, AICHI-KEN, 471-8571, JAPAN		
DATE OF REGISTRATION	25/06/2012	
TITLE	CAR	
PRIORITY		
PRIORITY NUMBER	DATE	COUNTRY
2011-030118	27/12/2011	JAPAN



DESIGN NUMBER	248865	
CLASS	08-06	
1)(1) MITESHBHAI B. PIPALIYA (2) HITESHBHAI M. PIPALIYA (3) JIGNESHBHAI B. HIRAPARA ALL INDIAN NATIONAL PARTNERS OF PATEL DIE CASTING AN INDIAN PARTNERSHIP FIRM HAVING ITS PRINCIPAL PLACE OF BUSINESS AT PATELNAGAR-4, OPP. SATYANARAYAN MILL, 80 FEET MAIN ROAD, RAJKOT, GUJARAT-INDIA		
DATE OF REGISTRATION	19/10/2012	
TITLE	HANDLE	
PRIORITY NA		



DESIGN NUMBER	248898
CLASS	07-01
1)RAVISSANT PRIVATE LIMITED, AN INDIAN COMPANY, OF 50-51, COMMERCIAL COMPLEX, NEW FRIENDS COLONY, NEW DELHI-110065, INDIA	
DATE OF REGISTRATION	19/10/2012
TITLE	SUGAR POT
PRIORITY NA	



DESIGN NUMBER	235812
CLASS	12-05
1)MR. ABHIMUKTHEESWARAR S-1/3, R.E. THERMAL QUARTERS, METTUR DAM, SALEM- 636401, INDIA	
DATE OF REGISTRATION	30/03/2011
TITLE	TRUCK
PRIORITY NA	



DESIGN NUMBER	239946	
CLASS	08-08	
1)KYOSHIN KOGYO CO., LTD., 20-7, EBIE-7-CHOME, FUKUSHIMA-KU, OSAKA-SHI, OSAKA, JAPAN		
DATE OF REGISTRATION	05/10/2011	
TITLE	COLLET CHUCK	
PRIORITY		
PRIORITY NUMBER	DATE	COUNTRY
30-2011-0013836	06/04/2011	REPUBLIC OF KOREA

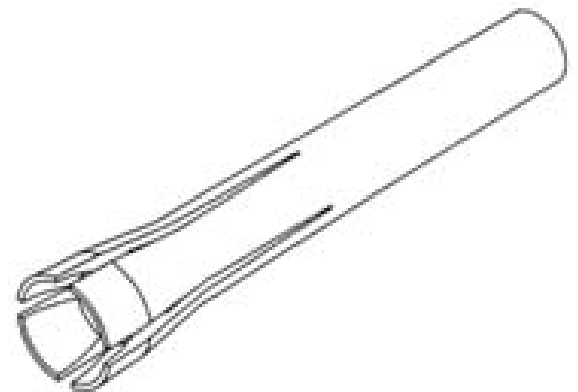

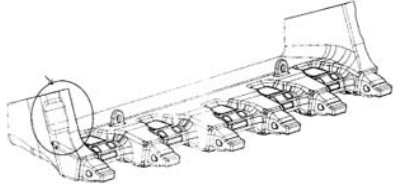
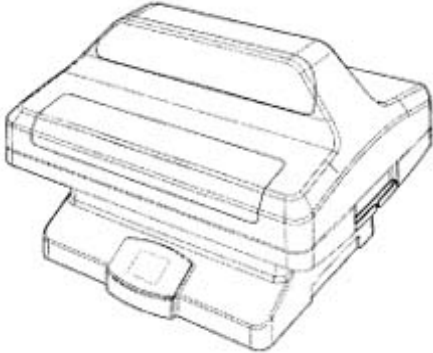
DESIGN NUMBER	245822		
CLASS	13-03		
1)YAZAKI CORPORATION, A JAPANESE CORPORATION OF 4-28, MITA 1-CHOME, MINATO-KU, TOKYO 108-0073, JAPAN			
DATE OF REGISTRATION	08/06/2012		
TITLE	HOUSING FOR ELECTRIC CONNECTOR		
PRIORITY			
PRIORITY NUMBER	DATE	COUNTRY	
2011-028632	09/12/2011	JAPAN	
DESIGN NUMBER	244092		
CLASS	15-04		
1)BRADKEN RESOURCES PTY LIMITED 2 MAUD STREET, MAYFIELD WEST, NEW SOUTH WALES 2304, AUSTRALIA			
DATE OF REGISTRATION	23/03/2012		
TITLE	LIP FOR EXCAVATION BUCKET		
PRIORITY			
PRIORITY NUMBER	DATE	COUNTRY	
14341/2011	27/09/2011	AUSTRALIA	
DESIGN NUMBER	241882		
CLASS	24-99		
1)SARTORIUS WEIGHING TECHNOLOGY GMBH WEENDER LANSTRASSE 94-108, 37075 GOETTINGEN, GERMANY,			
DATE OF REGISTRATION	27/12/2011		
TITLE	SHAKING DEVICE		
PRIORITY			
PRIORITY NUMBER	DATE	COUNTRY	
RCD 001287585-0002	02/08/2011	OHIM	

DESIGN NUMBER	247407		
CLASS	08-06		
1)GANGOTRI INDUSTRIES, INDIAN PROPRIETORSHIP FIRM HAVING PRINCIPAL PLACE OF BUSINESS AT PLOT NO. 41-A, UDHYOG NAGAR SOCIETY, NEAR KHODIYAR FABRICATION, KOTHARIYA RING ROAD, RAJKOT, GUJARAT, INDIA AND HAVING PROPRIETOR KESHUBHAI JASMATBHAI KAKADIYA, RESIDING AT NEAR NANDA HALL, B/H. KEDARNATH SOCIETY, NEW SAGAR SOCIETY, STEET NO. 2, KOTHARIYA ROAD, RAJKOT INDIAN NATIONALS			
DATE OF REGISTRATION	28/08/2012		
TITLE	HANDLE		
PRIORITY NA			
DESIGN NUMBER	243619		
CLASS	15-06		
1)STARLINGER & CO GESELLSCHAFT M.B.H SONNENUHRGASSE 4, A-1060 WIEN, AUSTRIA			
DATE OF REGISTRATION	05/03/2012		
TITLE	WEAVING LOOMS		
PRIORITY			
PRIORITY NUMBER	DATE	COUNTRY	
001917584-0001	14/09/2011	OHIM	
DESIGN NUMBER	248891		
CLASS	07-01		
1)RAVISSANT PRIVATE LIMITED, AN INDIAN COMPANY, OF 50-51, COMMERCIAL COMPLEX, NEW FRIENDS COLONY, NEW DELHI-110065, INDIA			
DATE OF REGISTRATION	19/10/2012		
TITLE	WATER JUG		
PRIORITY NA			

DESIGN NUMBER	246995	
CLASS	31-00	
1)KONINKLIJKE PHILIPS ELECTRONICS N.V., A COMPANY ORGANIZED AND EXISTING UNDER THE LAWS OF THE KINGDOM OF THE NETHERLANDS, RESIDING AT EINDHOVEN, WHOSE POST-OFFICE ADDRESS IS GROENEWOUDSEWEG 1, 5621 BA, EINDHOVEN, THE NETHERLANDS		
DATE OF REGISTRATION	06/08/2012	
TITLE	FOOD CLEANER	
PRIORITY		
PRIORITY NUMBER	DATE	COUNTRY
001987140-0001	06/02/2012	OHIM



DESIGN NUMBER	242480	
CLASS	07-08	
1)PATEL KASHIBHAI MANGALBHAI, AT. BHOJA POST. KHAROL TAL. LUNAWADA DIST. PANCHMAHAL PIN CODE-389220 GUJARAT INDIA		
DATE OF REGISTRATION	24/01/2012	
TITLE	FIRE BLOW OUT VALVE	
PRIORITY NA		



DESIGN NUMBER	242666	
CLASS	12-07	
1)AGUSTAWESTLAND S.P.A. SAMARATE (ITALY) - FRAZIONE CASCINA COSTA - VIA GIOVANNI AGUSTA, 520		
DATE OF REGISTRATION	30/01/2012	
TITLE	AIRCRAFT	
PRIORITY		
PRIORITY NUMBER	DATE	COUNTRY
1287205-0008	29/07/2011	OHIM

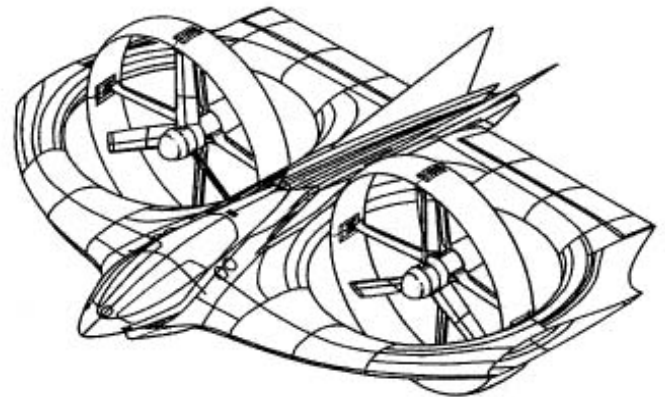

DESIGN NUMBER	245789	
CLASS	09-01	
1)THE GILLETTE COMPANY, A COMPANY INCORPORATED UNDER THE LAWS OF UNITED STATES OF AMERICA HAVING ITS REGISTERED OFFICE AT IP/LEGAL PATENT DEPARTMENT - 3E, ONE GILLETTE PARK, BOSTON, MASSACHUSETTS 02127, UNITED STATES OF AMERICA		
DATE OF REGISTRATION	07/06/2012	
TITLE	PERSONAL CARE BOTTLE	
PRIORITY		
PRIORITY NUMBER	DATE	COUNTRY
29/408,268	09/12/2011	U.S.A.



DESIGN NUMBER	244127	
CLASS	09-05	
1)XELLIA PHARMACEUTICALS APS DALSLANDSGATE 11, 2300 KOBENHAVN S, DENMARK		
DATE OF REGISTRATION	26/03/2012	
TITLE	BAG WITH CLOSING DEVICE	
PRIORITY		
PRIORITY NUMBER	DATE	COUNTRY
20110987	12/12/2011	NORWAY

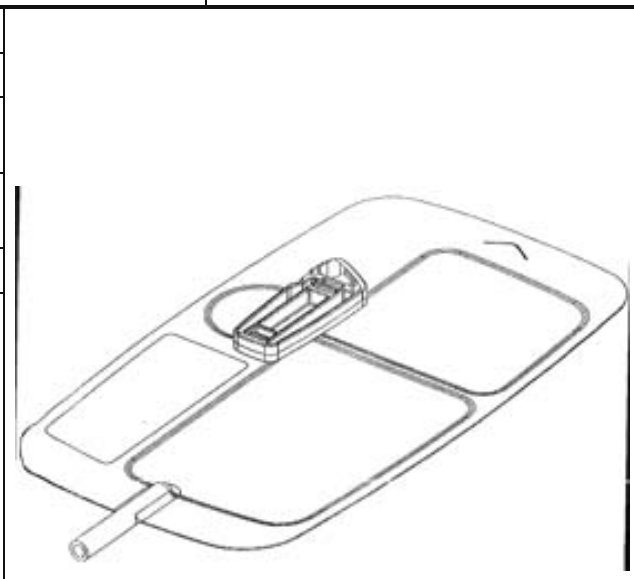

DESIGN NUMBER	247560	
CLASS	24-04	
1)TEIKOKU SEIYAKU CO., LTD., 567, SANBONMATSU, HIGASHIKAGAWA-SHI, KAGAWA 7692695, JAPAN, A JAPANESE COMPANY		
DATE OF REGISTRATION	31/08/2012	
TITLE	ADHESIVE SKIN PATCH	
PRIORITY		
PRIORITY NUMBER	DATE	COUNTRY
2012-004691	02/03/2012	JAPAN

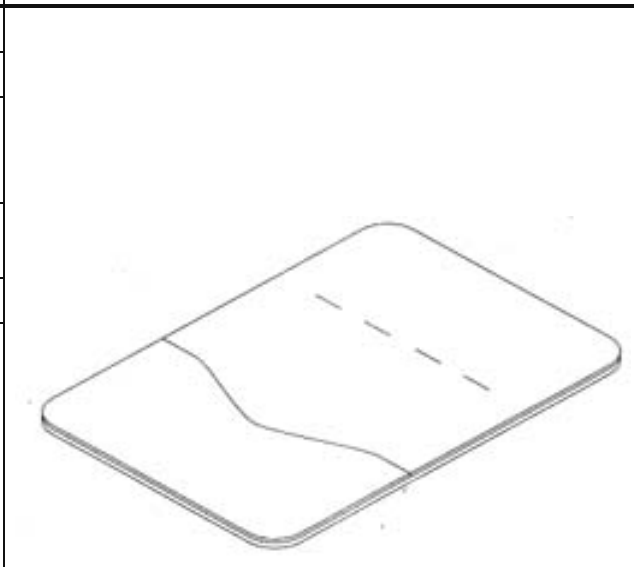

DESIGN NUMBER	245335	
CLASS	07-05	
1)KONINKLIJKE PHILIPS ELECTRONICS N.V., A COMPANY ORGANIZED AND EXISTING UNDER THE LAWS OF THE KINGDOM OF THE NETHERLANDS, RESIDING AT EINDHOVEN, WHOSE POST-OFFICE ADDRESS IS GROENEWOUDSEWEG 1, 5621 BA, EINDHOVEN, THE NETHERLANDS		
DATE OF REGISTRATION	15/05/2012	
TITLE	GARMENT STEAMER	
PRIORITY		
PRIORITY NUMBER	DATE	COUNTRY
001948241-0001	16/11/2011	OHIM

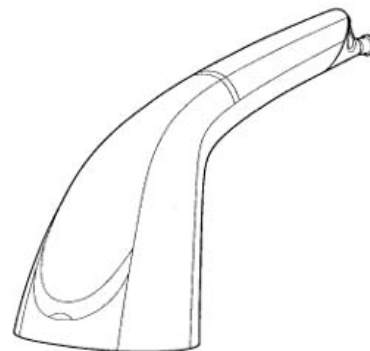

DESIGN NUMBER	245498	
CLASS	28-02	
1)M/S. NANDI SOAPS PRIVATE LIMITED, A COMPANY INCORPORATED UNDER THE LAWS OF INDIA WHOSE ADDRESS IS BANK ROAD, RAXAUL-845 305 (BIHAR)		
DATE OF REGISTRATION	23/05/2012	
TITLE	SOAP	
PRIORITY NA		



DESIGN NUMBER	245978	
CLASS	09-07	
1)THOMAS C. FORD, A CITIZEN OF U.S.A., C/O SHAPIRO & COMPANY, C.P.A., 9229 SUNSET BLVD., SUITE 607, LOS ANGELES, CA 90069, USA		
DATE OF REGISTRATION	14/06/2012	
TITLE	CAP FOR A FRAGRANCE BOTTLE	
PRIORITY		
PRIORITY NUMBER	DATE	COUNTRY
29/408,571	14/12/2011	U.S.A.

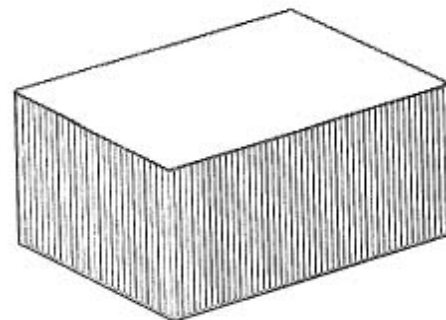

DESIGN NUMBER	246263		
CLASS	13-03		
1)SABIC INNOVATIVE PLASTICS IP B.V., A CORPORATION ORGANIZED AND EXISTING UNDER THE LAWS OF THE NETHERLANDS, OF THE ADDRESS PLASTICSLAAN 1, 4612 PX BERGEN OP ZOOM (NL), NETHERLANDS			
DATE OF REGISTRATION	28/06/2012		
TITLE	POWER INVERTER		
PRIORITY NA			
DESIGN NUMBER	248841		
CLASS	08-07		
1)MANISHABEN SUNILBHAI PANCHAL, HAVING NATIONALITY INDIAN, SOLE PROPRIETOR OF FAIRMAX TECHNOLOGY, 24, MADHURAM COMPLEX, SUBHASHBRIDGE, AHMEDABAD-380027, GUJARAT, INDIA, AN INDIAN SOLE PROPRIETARY CONCERN			
DATE OF REGISTRATION	16/10/2012		
TITLE	PUSH TYPE LOCKING SEAL		
PRIORITY NA			
DESIGN NUMBER	240694		
CLASS	14-02		
1)REV WORLDWIDE, INC., 601 N.LAMAR BLVD., AUSTIN, TEXAS 78703 USA			
DATE OF REGISTRATION	09/11/2011		
TITLE	ELECTRONIC PAYMENT DEVICE		
PRIORITY			
PRIORITY NUMBER	DATE	COUNTRY	
29/391, 512	10/05/2011	U.S.A.	

DESIGN NUMBER	246293		
CLASS	23-04		
1)NOVENCO A/S, A DANISH COMPANY OF INDUSTRIVEJ 22, 4700 NAESTVED, DENMARK			
DATE OF REGISTRATION	29/06/2012		
TITLE	VENTILATOR BLADE		
PRIORITY			
PRIORITY NUMBER	DATE	COUNTRY	
001985391-0001	02/02/2012	OHIM	
DESIGN NUMBER	246307		
CLASS	10-04		
1)FMI LIMITED, A COMPANY INCORPORATED UNDER THE INDIAN COMPANIES ACT, AT FEROREPORE ROAD, LUDHIANA-141001, PUNJAB, INDIA			
DATE OF REGISTRATION	02/07/2012		
TITLE	MEASURING TAPE		
PRIORITY NA			
DESIGN NUMBER	248493		
CLASS	08-06		
1)MAHESHBHAI SHIVALALBHAI GAJERA AN INDIAN NATIONAL PROPRIETOR OF SHREE HARIKRUPA DIE CASTING AN INDIAN PROPRIETORSHIP FIRM HAVING ITS PRINCIPAL PLACE OF BUSINESS AT K-1, 242/17, B/4 MEL-TECH, NEAR TURBO BEARING, AJI VASAHAAT GIDC, RAJKOT-360002, GUJARAT-INDIA			
DATE OF REGISTRATION	08/10/2012		
TITLE	HANDLE		
PRIORITY NA			

DESIGN NUMBER	242507	
CLASS	05-06	
1) LG HAUSYS, LTD. 20, YEOUIDO-DONG, YEONGDEUNGPO-GU, SEOUL 150-721, REPUBLIC OF KOREA		
DATE OF REGISTRATION	25/01/2012	
TITLE	SHEET FOR VEHICLE SEATS	
PRIORITY		
PRIORITY NUMBER	DATE	COUNTRY
KR 30-2011-0035447	25/08/2011	REPUBLIC OF KOREA





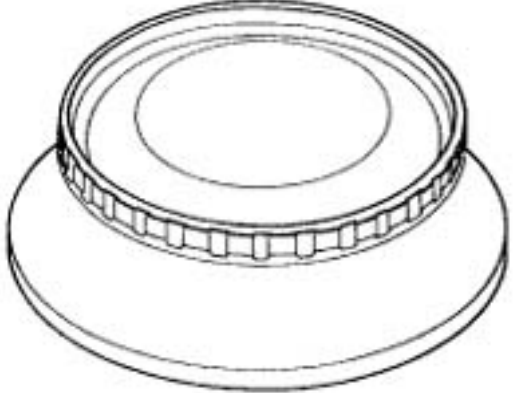



DESIGN NUMBER	223529	
CLASS	09-07	
1) SURENSO S.L PLACA JOSEP BERENGUER 12, 08400-GRANOLLERS (BARCELONA) SPAIN		
DATE OF REGISTRATION	23/06/2009	
TITLE	CAN CLOSURE	
PRIORITY		
PRIORITY NUMBER	DATE	COUNTRY
001063135-0002	24/12/2008	OHIM

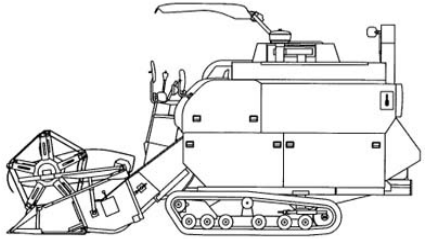

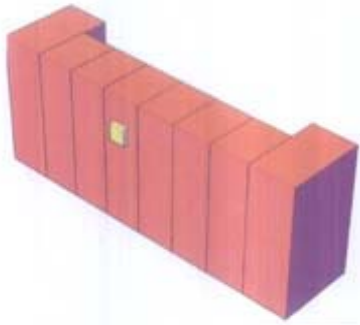

DESIGN NUMBER	247566	
CLASS	24-04	
1) TEIKOKU SEIYAKU CO., LTD., 567, SANBONMATSU, HIGASHIKAGAWA-SHI, KAGAWA 7692695 JAPAN, A JAPANESE COMPANY		
DATE OF REGISTRATION	31/08/2012	
TITLE	ADHESIVE SKIN PATCH	
PRIORITY		
PRIORITY NUMBER	DATE	COUNTRY
2012-011386	16/05/2012	JAPAN



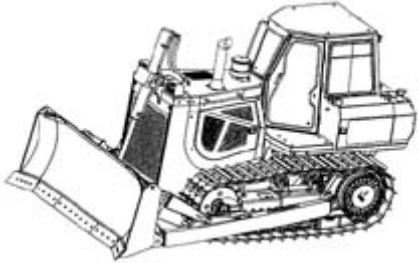

DESIGN NUMBER	245543		
CLASS	15-03		
1)YANMAR CO., LTD., A JAPANESE CO., OF 1-9, TSURUNOCHO, KITA-KU, OSAKA-SHI, OSAKA 5308311, JAPAN			
DATE OF REGISTRATION	23/05/2012		
TITLE	COMBINE		
PRIORITY			
PRIORITY NUMBER	DATE	COUNTRY	
2011-028693	09/12/2011	JAPAN	
DESIGN NUMBER	241038		
CLASS	23-04		
1)FABER S.P.A., VIALE XIII LUGLIO, 160, 60044 FABRIANO (AN), ITALY			
DATE OF REGISTRATION	25/11/2011		
TITLE	KITCHEN HOOD		
PRIORITY			
PRIORITY NUMBER	DATE	COUNTRY	
DM/076 199	30/05/2011	WIPO	
DESIGN NUMBER	243532		
CLASS	13-03		
1)BHARAT HEAVY ELECTRICALS LIMITED, REGIONAL OFFICES AT REGIONAL OPERATIONS DIVISION (ROD), PLOT NO. 9/1, DJ BLOCK, 3RD FLOOR, KARUNAMOYEE, SALT LAKE CITY, KOLKATA-700091			
DATE OF REGISTRATION	29/02/2012		
TITLE	SWITCHGEAR PANEL		
PRIORITY NA			

DESIGN NUMBER	245993		
CLASS	07-04		
1)ASHABEN GOPALBHAI PATEL AN INDIAN NATIONAL AND PROPRIETOR OF SHIV CERAMICS HAVING MY PLACE OF BUSINESS AT PLOT NO. 414, G.I.D.C. ESTATE, PHASE-IV, AHMEDABAD-382330 - (GUJARAT) (INDIA)			
DATE OF REGISTRATION	15/06/2012		
TITLE	POT		
PRIORITY NA			
DESIGN NUMBER	246020		
CLASS	10-02		
1)HUBLOT SA, GENEVE, A LIMITED COMPANY, INCORPORATED UNDER THE LAWS OF SWITZERLAND OF RUE DE LA FONTAINE 7, 1204, GENEVE, SWITZERLAND			
DATE OF REGISTRATION	19/06/2012		
TITLE	WATCH		
PRIORITY			
PRIORITY NUMBER	DATE	COUNTRY	
644916001	22/12/2011	WIPO	
DESIGN NUMBER	242437		
CLASS	26-02		
1)BPL LIMITED 11TH KM, ARAKERE, BANNERGHATTA ROAD, BANGALORE - 560076, INDIA			
DATE OF REGISTRATION	23/01/2012		
TITLE	TORCH		
PRIORITY NA			

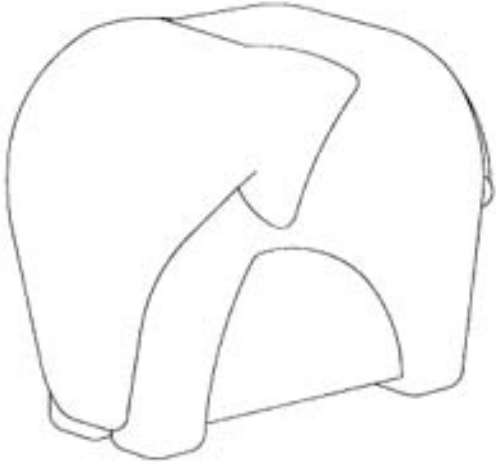
DESIGN NUMBER	242503		
CLASS	05-06		
1) LG HAUSYS, LTD., 20, YEOUIDO-DONG, YEONGDEUNGPO-GU, SEOUL 150-721, REPUBLIC OF KOREA			
DATE OF REGISTRATION	25/01/2012		
TITLE	SHEET FOR VEHICLE SEATS		
PRIORITY			
PRIORITY NUMBER	DATE	COUNTRY	
KR 30-2011-0035438	25/08/2011	REPUBLIC OF KOREA	
DESIGN NUMBER	245821		
CLASS	13-03		
1) YAZAKI CORPORATION, A JAPANESE CORPORATION OF 4-28, MITA 1-CHOME, MINATO-KU, TOKYO 108-0073, JAPAN			
DATE OF REGISTRATION	08/06/2012		
TITLE	HOUSING FOR ELECTRIC CONNECTOR		
PRIORITY			
PRIORITY NUMBER	DATE	COUNTRY	
2011-028628	09/12/2011	JAPAN	
DESIGN NUMBER	246088		
CLASS	15-04		
1) CATERPILLAR INC., A CORPORATION ORGANIZED AND EXISTING UNDER THE LAWS OF THE STATE OF DELAWARE, UNITED STATES OF AMERICA, HAVING A PLACE OF BUSINESS AT 100 N.E. ADAMS STREET, PEORIA, ILLINOIS 61629, UNITED STATES OF AMERICA			
DATE OF REGISTRATION	21/06/2012		
TITLE	EARTH MOVER		
PRIORITY			
PRIORITY NUMBER	DATE	COUNTRY	
201130501165.4	21/12/2011	CHINA	

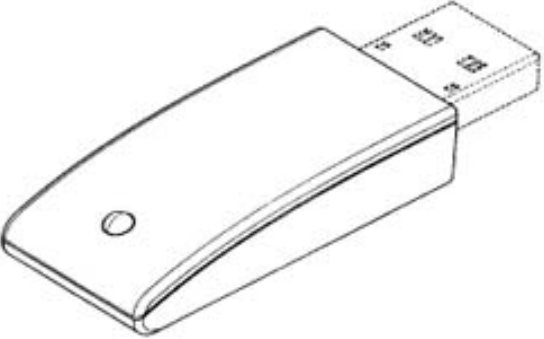
DESIGN NUMBER	246264	
CLASS	13-03	
1)SABIC INNOVATIVE PLASTICS IP B.V., A CORPORATION ORGANIZED AND EXISTING UNDER THE LAWS OF THE NETHERLANDS, OF THE ADDRESS PLASTICSLAAN 1, 4612 PX BERGEN OP ZOOM (NL), NETHERLANDS		
DATE OF REGISTRATION	28/06/2012	
TITLE	POWER INVERTER	
PRIORITY NA		

DESIGN NUMBER	230015	
CLASS	14-02	
1)SANFORD, L.P., 2707 BUTTERFIELD ROAD, OAK BROOK, ILLINOIS 60523, U.S.A.,		
DATE OF REGISTRATION	29/06/2010	
TITLE	WIRELESS RECEIVER	
PRIORITY		
PRIORITY NUMBER	DATE	COUNTRY
29/352, 994	30/12/2009	U.S.A.

DESIGN NUMBER	243680	
CLASS	09-07	
1)PULLCROWN GMBH PETRUSGASSE 5, 1030 WIEN, AUSTRIA		
DATE OF REGISTRATION	06/03/2012	
TITLE	BOTTLE CLOSURES	
PRIORITY		
PRIORITY NUMBER	DATE	COUNTRY
001914383	08/09/2011	OHIM

DESIGN NUMBER	246308	
CLASS	10-04	
1)FMI LIMITED, A COMPANY INCORPORATED UNDER THE INDIAN COMPANIES ACT, AT FEROREPORE ROAD, LUDHIANA-141001, PUNJAB, INDIA.		
DATE OF REGISTRATION	02/07/2012	
TITLE	MEASURING TAPE	
PRIORITY NA		
DESIGN NUMBER	242477	
CLASS	07-08	
1)PATEL KASHIBHAI MANGALBHAI, AT. BHOJA POST. KHAROL TAL. LUNAWADA DIST. PANCHMAHAL PIN CODE-389220 GUJARAT INDIA		
DATE OF REGISTRATION	24/01/2012	
TITLE	FIRE BLOW OUT VALVE	
PRIORITY NA		
DESIGN NUMBER	247537	
CLASS	25-01	
1)RAHUL JINDAL (DIRECTOR) & KIRAN JAIN (DIRECTOR), ARE INDIAN, TRADING AS LOOM CRAFTS FURNITURE (INDIA) PVT. LTD. (THIS COMPANY IS REGISTERED UNDER INDIAN COMPANIES ACT-1956) WHOSE ADDRESS IS A-7/98 & 99, SOUTH SIDE OF G. T. ROAD, INDUSTRIAL AREA, GHAZIABAD-201009 (U.P.) (INDIA)		
DATE OF REGISTRATION	31/08/2012	
TITLE	EXTRUDED ALUMINIUM CLADDING	
PRIORITY NA		

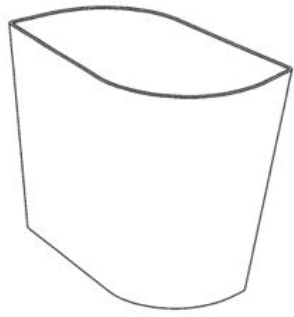
DESIGN NUMBER	247608		
CLASS	12-11		
1)HONDA MOTOR CO., LTD., A JAPANESE CORPORATION, OF 1-1, MINAMI-AOYAMA 2-CHOME, MINATO-KU, TOKYO, JAPAN			
DATE OF REGISTRATION	04/09/2012		
TITLE	MOTORCYCLE		
PRIORITY			
PRIORITY NUMBER	DATE	COUNTRY	
2012-005262	08/03/2012	JAPAN	
DESIGN NUMBER	241746		
CLASS	09-03		
1)HINDUSTAN UNILEVER LIMITED, UNILEVER HOUSE, B. D. SAWANT MARG, CHAKALA, ANDHERI (EAST), MUMBAI 400 099, STATE OF MAHARASHTRA, INDIA.			
DATE OF REGISTRATION	23/12/2011		
TITLE	CONTAINER		
PRIORITY			
PRIORITY NUMBER	DATE	COUNTRY	
001884842-0004	30/06/2011	OHIM	
DESIGN NUMBER	245328		
CLASS	09-01		
1)SAVERGLASS, A FRENCH COMPANY OF 3 RUE DE LA GARE, 60960 FEUQUIERES, FRANCE			
DATE OF REGISTRATION	15/05/2012		
TITLE	BOTTLE		
PRIORITY			
PRIORITY NUMBER	DATE	COUNTRY	
001949322-0001	18/11/2011	OHIM	

DESIGN NUMBER	245983	
CLASS	14-01	
1)CLARION CO., LTD., OF 7-2, SHINTOSHIN, CHUO-KU, SAITAMA-SHI, SAITAMA 330-0081, JAPAN, A JAPANESE COMPANY		
DATE OF REGISTRATION	14/06/2012	
TITLE	DIGITAL AUDIO PLAYER FOR VEHICLES	
PRIORITY		
PRIORITY NUMBER	DATE	COUNTRY
201230012025.5	16/01/2012	CHINA

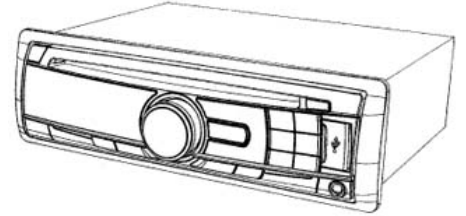

DESIGN NUMBER	248893	
CLASS	07-01	
1)RAVISSANT PRIVATE LIMITED, AN INDIAN COMPANY, OF 50-51, COMMERCIAL COMPLEX, NEW FRIENDS COLONY, NEW DELHI-110065, INDIA		
DATE OF REGISTRATION	19/10/2012	
TITLE	DISH WITH LID	
PRIORITY NA		



DESIGN NUMBER	246996	
CLASS	26-06	
1)KONINKLIJKE PHILIPS ELECTRONICS N.V., A COMPANY ORGANIZED AND EXISTING UNDER THE LAWS OF THE KINGDOM OF THE NETHERLANDS, RESIDING AT EINDHOVEN, WHOSE POST-OFFICE ADDRESS IS GROENEWOUDSEWEG 1, 5621 BA, EINDHOVEN, THE NETHERLANDS		
DATE OF REGISTRATION	06/08/2012	
TITLE	LED TRUCK LIGHT	
PRIORITY		
PRIORITY NUMBER	DATE	COUNTRY
001987223-0001	06/02/2012	OHIM

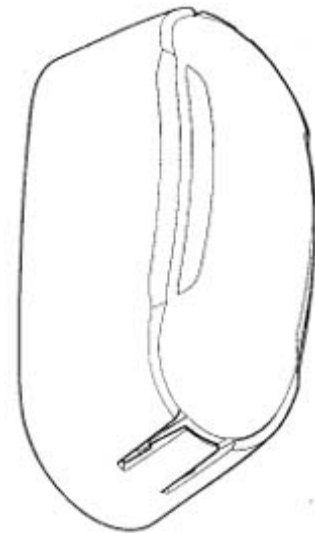

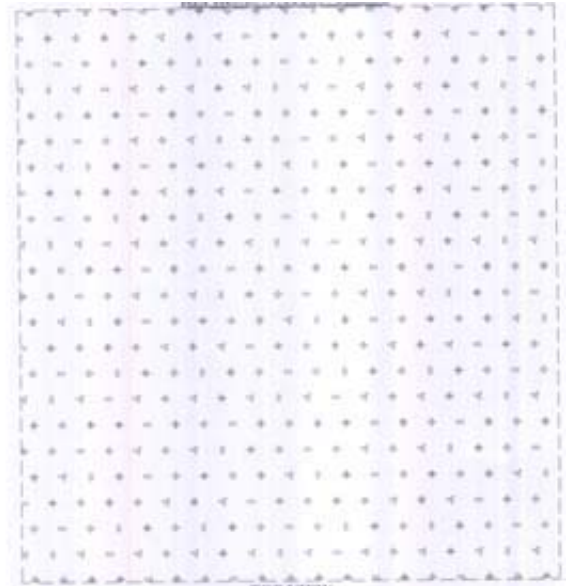

DESIGN NUMBER	242486	
CLASS	15-03	
1)TIRTH AGRO TECHNOLOGY PVT LTD SHAKTIMAN, SURVEY NO. 108/1, PLOT NO B, AT: BHUNAVA, NEAR GOVARDHAN GINNING, NATIONAL HIGHWAY NO 8B, AFTER BHARUDI TOLL PLAZA, TAL: GONDAL, RAJKOT 360311, GUJARAT, INDIA		
DATE OF REGISTRATION	24/01/2012	
TITLE	HARROW FOR AGRICULTURE USE	
PRIORITY NA		

DESIGN NUMBER	242516	
CLASS	05-06	
1)LG HAUSYS, LTD., 20, YEOUIDO-DONG, YEONGDEUNGPO-GU, SEOUL 150-721, REPUBLIC OF KOREA		
DATE OF REGISTRATION	25/01/2012	
TITLE	SHEET FOR VEHICLE SEATS	
PRIORITY		
PRIORITY NUMBER	DATE	COUNTRY
KR 30-2011-0035450	25/08/2011	REPUBLIC OF KOREA

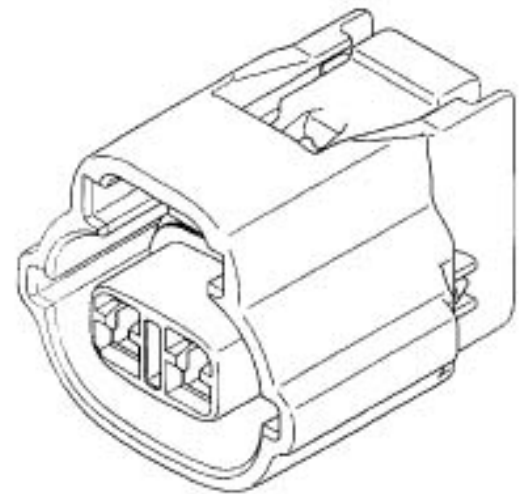

DESIGN NUMBER	245819	
CLASS	13-03	
1)YAZAKI CORPORATION, A JAPANESE CORPORATION OF 4-28, MITA 1-CHOME, MINATO-KU, TOKYO 108-0073, JAPAN		
DATE OF REGISTRATION	08/06/2012	
TITLE	HOUSING FOR ELECTRIC CONNECTOR	
PRIORITY		
PRIORITY NUMBER	DATE	COUNTRY
2011-028633	09/12/2011	JAPAN

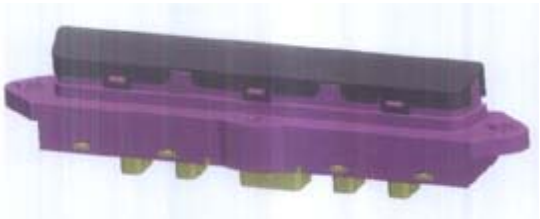
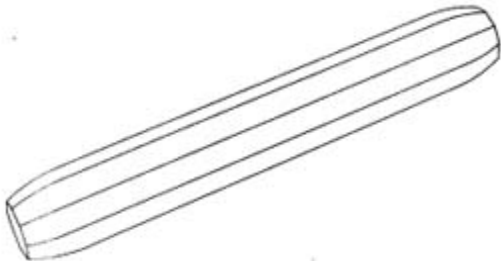

DESIGN NUMBER	248575		
CLASS	12-11		
1)EASTMAN INDUSTRIES LIMITED, C-87, PHASE-V, FOCAL POINT, LUDHIANA-141010 (PUNJAB) INDIA (AN INDIAN COMPANY DULY REGISTERED UNDER THE COMPANIES ACT, 1956) OF THE ABOVE ADDRESS			
DATE OF REGISTRATION	05/10/2012		
TITLE	CARRIER FOR BICYCLE		
PRIORITY NA			
DESIGN NUMBER	245426		
CLASS	12-16		
1)MINDARIKA PRIVATE LIMITED., AN INDIAN COMPANY OF VILL. NAWADA FATEPUR, P.O. SIKANDERPUR BADDA, MANESAR, DISTT. GURGAON, HARYANA-122004, INDIA			
DATE OF REGISTRATION	18/05/2012		
TITLE	TOUCH BASED SWITCH BANK		
PRIORITY NA			
DESIGN NUMBER	245448		
CLASS	27-99		
1)PHILIPS MORRIS PRODUCTS S.A., QUAI JEANRENAUD 3, 2000 NEUCHATEL, SWITZERLAND			
DATE OF REGISTRATION	21/05/2012		
TITLE	SMOKERS ACCESSORIES		
PRIORITY			
PRIORITY NUMBER	DATE	COUNTRY	
001303150-0005	21/11/2011	OHIM	