

## ***CONTINUED FROM PART- 1***

### **INTRODUCTION**

In view of the recent amendment made in the Designs (Amendment) Rules, 2008 with effect from 17/06/2008, Publication of the matter relating to Designs is being published in the Official Journal of The Patent Office. This Journal is being published on weekly basis on every Friday covering the various proceedings on Designs as required according to the provisions of under Rule 22, 25, 27 and 39 of the Design (Amendment) Rules, 2008. All the enquiries on this Official Journal and other information as required by the public should be addressed to the Controller General of Patents, Designs & Trade Marks. Suggestions and comments are requested from all quarters so that the content can be enriched.

**DESIGN**  
**CORRIGENDUM**

**The Registered Design No. 238356 which has been erroneously published in the official Journal of India dated 15/02/2013, part –II, at page 4770, column 2 in the name of Daimler India Commercial Vehicles Pvt. Ltd., Unit 301 & 302, 3 RD Floor Campus 3 B, RMZ Millennia Business Park No. 143, DR. MGR Road, Perugudi, Chennai 600096, India, Class 12-08, Date of Registration 27/07/2011, Titled as Front Assembly of a Truck, Priority Number 001850470-0002, Date 13/04/2011, Country OHIM should read as Daimler India Commercial Vehicles Pvt. Ltd., Unit 301 & 302, 3 RD Floor Campus 3 B, RMZ Millennia Business Park No. 143, DR. MGR Road, Perungudi, Chennai 600096, India, Class 12-08, Date of Registration 27/07/2011, Titled as Front Assembly of a Truck, Priority Number 001850470-0002, Date 13/04/2011, Country OHIM**

## **COPYRIGHT PUBLICATION**

<b>SL NO</b>	<b>CASE NUMBERS</b>	<b>RENEWED ON</b>
<b>1.</b>	<b>239461</b>	<b>02.04.2013</b>
<b>2.</b>	<b>179735</b>	<b>03.04.2013</b>
<b>3.</b>	<b>188751</b>	<b>03.04.2013</b>
<b>4.</b>	<b>193559</b>	<b>03.04.2013</b>
<b>5.</b>	<b>241518</b>	<b>03.04.2013</b>
<b>6.</b>	<b>246142</b>	<b>03.04.2013</b>
<b>7.</b>	<b>188919</b>	<b>04.04.2013</b>
<b>8.</b>	<b>190539</b>	<b>04.04.2013</b>
<b>9.</b>	<b>192254</b>	<b>04.04.2013</b>
<b>10.</b>	<b>193434</b>	<b>04.04.2013</b>

**THE DESIGNS ACT 2000**  
**SECTION 30**  
**DESIGN ASSIGNMENT**

The Design stands in the name of SARA LEE/DE B.V. (CO-PROPRIETOR) registered under the Designs Act, 2000 has been assigned in the Register of Designs in the name as follows:-

<b>Design No.</b>	<b>Class</b>	<b>Name</b>
214244	07-02	<b>KONINKLIJKE DOUWE EGBERTS B.V., OF OOSTERDOKSSTRAAT 80, 1011 DK AMSTERDAM, THE NETHERLANDS, A NETHERLAND COMPANY</b>
221713	07-02	
226854	07-02	
234228	07-01	
237331	07-02	
238919	07-02	
238920	07-02	
238921	07-02	

## REGISTRATION OF DESIGNS



The following designs have been registered. They are now open for public inspection. In the following each entry the Date of Registration is shown. The Priority Number, Priority Date and Priority Country are also shown

<b>DESIGN NUMBER</b>	242251		
<b>CLASS</b>	24-01		
<b>1)FRITZ RUCK OPHTHALMOLOGISCHE SYSTEME GMBH</b> J LICHER STRASSE 115, 52249 ESCHWEILER, GERMANY			
<b>DATE OF REGISTRATION</b>	13/01/2012		
<b>TITLE</b>	AN OPHTHALMOLOGICAL APPARATUS		
<b>PRIORITY</b>			
<b>PRIORITY NUMBER</b>	<b>DATE</b>	<b>COUNTRY</b>	
001285407-0005	14/07/2011	EUROPEAN UNION	
<b>PRIORITY NA</b>			
<b>DESIGN NUMBER</b>	247108		
<b>CLASS</b>	25-01		
<b>1)MR. CHANDRAKANT S. MANIYAL AN INDIVIDUAL - INDIAN RESIDENT</b> OF, 1, LAXMI NARAYAN COLONY, THANKAR PADA, AGRA ROAD, KALYAN(W)-421301. MAHARASHTRA, INDIA			
<b>DATE OF REGISTRATION</b>	13/08/2012		
<b>TITLE</b>	BEAM BOTTOM		
<b>PRIORITY NA</b>			
<b>DESIGN NUMBER</b>	249683		
<b>CLASS</b>	21-01		
<b>1)MR. ADITYA SINGHAL (AN INDIAN NATIONAL), TRADING AS M/S. UDITI INTERNATIONAL,</b> 3528, 1ST FLOOR (MEZANNINE), SADAR BAZAR, DELHI-110006.			
<b>DATE OF REGISTRATION</b>	26/11/2012		
<b>TITLE</b>	TOY		
<b>PRIORITY NA</b>			

<b>DESIGN NUMBER</b>	249721	
<b>CLASS</b>	12-16	
<b>1)DEERE &amp; COMPANY, A US CORPORATION OF</b> ONE JOHN DEERE PLACE, MOLINE, ILLINOIS, 61265 - 8098, USA		
<b>DATE OF REGISTRATION</b>	27/11/2012	
<b>TITLE</b>	SEAT POD FOR A WORK VEHICLE	
<b>PRIORITY NA</b>		

<b>DESIGN NUMBER</b>	242505		
<b>CLASS</b>	05-06		
<b>1)LG HAUSYS, LTD.,</b> 20, YEOUIDO-DONG, YEONGDEUNGPO-GU, SEOUL 150-721, REPUBLIC OF KOREA			
<b>DATE OF REGISTRATION</b>	25/01/2012		
<b>TITLE</b>	SHEET FOR VEHICLE SEATS		
<b>PRIORITY</b>			
<b>PRIORITY NUMBER</b>	<b>DATE</b>	<b>COUNTRY</b>	
KR 30-2011-0035440	25/08/2011	REPUBLIC OF KOREA	

<b>DESIGN NUMBER</b>	249085		
<b>CLASS</b>	12-16		
<b>1)(1) SHRI HARESHKUMAR PREMJBHAI HADVANI, (2) SHRI KIRITKUMAR PREMJBHAI HADVANI (3) SHRI PRAVINKUMAR PREMJBHAI HADVANI (4) SHRI ASHOKKUMAR PREMJBHAI HADVANI (5) SHRI HITESHBHAI BABUBHAI SAKARIYA AND (6) SHRI VINODBHAI BABUBHAI SAKARIYA ALL INDIAN NATIONAL AND PARTNERS OF ISK BEARINGS INDUSTRIES (A PARTNERSHIP FIRM) HAVING OUR PLACE OF BUSINESS AT</b> PLOT NO. G-1513, LODHIKA, G.I.D.C., METODA-360021, DIST. RAJKOT, GUJARAT (INDIA)			
<b>DATE OF REGISTRATION</b>	30/10/2012		
<b>TITLE</b>	WHEEL HUB UNIT		
<b>PRIORITY NA</b>			

<b>DESIGN NUMBER</b>	248004	
<b>CLASS</b>	07-03	
<b>1)MA DESIGN INDIA PRIVATE LIMITED, A COMPANY INCORPORATED IN INDIA HAVING ITS PRINCIPAL PLACE OF BUSINESS</b> AT A-41, SECTOR-80, PHASE-II, NOIDA-201305, U.P. INDIA		
<b>DATE OF REGISTRATION</b>	19/09/2012	
<b>TITLE</b>	SPOON	
<b>PRIORITY NA</b>		
<b>DESIGN NUMBER</b>	245684	
<b>CLASS</b>	03-01	
<b>1)FAZELHAQ MOHAMMEDKASAM AKHUNJI (ADULT AND INDIAN NATIONAL) SOLE PROPRIETOR OF FREEHAND MARKETING (INDIAN PROPRIETORSHIP CONCERN) HAVING PLACE OF BUSINESS</b> AT: 1167, KARODA STREET, PANCHPATTI, KALUPUR, AHMEDABAD-380 001-GUJARAT (INDIA)		
<b>DATE OF REGISTRATION</b>	04/06/2012	
<b>TITLE</b>	BAG	
<b>PRIORITY NA</b>		
<b>DESIGN NUMBER</b>	249108	
<b>CLASS</b>	26-02	
<b>1)LEADING POINT POWERTRONICS PVT. LTD. A-11, OKHLA INDUSTRIAL AREA, PHASE-1, NEW DELHI-110020. (INDIA).</b> (AN INDIAN COMPANY DULY REGISTERED UNDER THE COMPANIES ACT, 1956)		
<b>DATE OF REGISTRATION</b>	31/10/2012	
<b>TITLE</b>	BATTERY LANTERN	
<b>PRIORITY NA</b>		

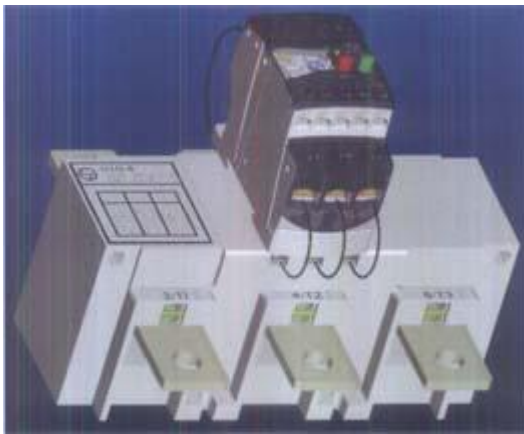
<b>DESIGN NUMBER</b>	249409	
<b>CLASS</b>	13-03	
<b>1) LARSEN &amp; TOUBRO LIMITED, AN INDIAN COMPANY INCORPORATED UNDER THE COMPANIES ACT, 1956 OF L &amp; T HOUSE, BALLARD ESTATE, MUMBAI 400 001, STATE OF MAHARASHTRA, INDIA</b>		
<b>DATE OF REGISTRATION</b>	09/11/2012	
<b>TITLE</b>	THERMAL OVERLOAD RELAY	
<b>PRIORITY NA</b>		



<b>DESIGN NUMBER</b>	247500
<b>CLASS</b>	02-04
<b>1) BUNNY POLY PLAST (INDIA) (AN INDIAN PARTNERSHIP CONCERN) AT C-16, SITE A, SIKANDRA INDUSTRIAL AREA, AGRA (U.P.) INDIA, WHOSE PARTNRS ARE VIJAY KUMAR VIJ, SMT. RITA VIJ &amp; ROHIT VIJ, ALL ARE INDIANS, R/O 46, BHARATPUR HOUSE, AGRA (U.P.) INDIA, OF THE ABOVE ADDRESS</b>	
<b>DATE OF REGISTRATION</b>	30/08/2012
<b>TITLE</b>	SOLE OF FOOTWEAR
<b>PRIORITY NA</b>	



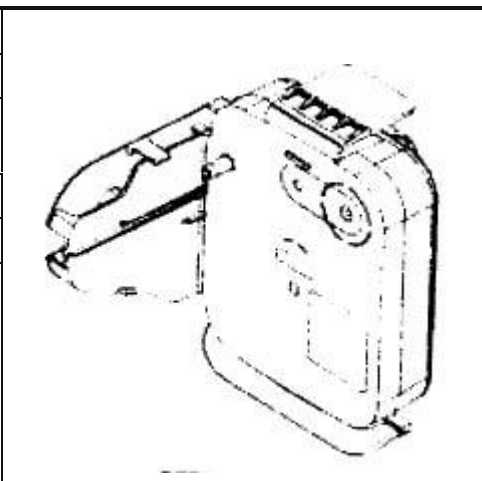

<b>DESIGN NUMBER</b>	242250	
<b>CLASS</b>	24-01	
<b>1) FRITZ RUCK OPHTHALMOLOGISCHE SYSTEME GMBH J LICHER STRASSE 115, 52249 ESCHWEILER, GERMANY</b>		
<b>DATE OF REGISTRATION</b>	13/01/2012	
<b>TITLE</b>	AN OPHTHALMOLOGICAL APPARATUS	
<b>PRIORITY</b>		
<b>PRIORITY NUMBER</b>	<b>DATE</b>	<b>COUNTRY</b>
001285407-0004	14/07/2011	EUROPEAN UNION







<b>DESIGN NUMBER</b>	247050	
<b>CLASS</b>	06-10	
<b>1)(1). BANKIMBHAI VELJIBHAI MANVAR, (2) ALPESHBHAI HASMUKHBHAI PARIKH (3) VINESHBHAI RATILAL DADHANIYA (4). MITKUMAR KISHORBHAI DEPANI., ALL INDIAN NATIONAL PARTNERS OF M/S. BARRY CREATION., AN INDIAN PARTNERSHIP FIRM., HAVING ITS PRINCIPLE PLACE OF BUSINESS</b> AT, 901, RAVI TOWER, OPP. PARIMAL SCHOOL, KALAWAD ROAD, RAJKOT-360004. GUJARAT-INDIA.		
<b>DATE OF REGISTRATION</b>	08/08/2012	
<b>TITLE</b>	CURTAIN BLIND	
<b>PRIORITY NA</b>		
<b>DESIGN NUMBER</b>	247107	
<b>CLASS</b>	25-01	
<b>1)MR. CHANDRAKANT S. MANIYAL AN INDIVIDUAL - INDIAN RESIDENT</b> OF, 1, LAXMI NARAYAN COLONY, THANKAR PADA, AGRA ROAD, KALYAN(W)-421301. MAHARASHTRA, INDIA		
<b>DATE OF REGISTRATION</b>	13/08/2012	
<b>TITLE</b>	COLUMN COVER	
<b>PRIORITY NA</b>		
<b>DESIGN NUMBER</b>	249682	
<b>CLASS</b>	01-01	
<b>1)M/S. SWEETON FOODS PVT. LTD., (A COMPANY DULY INCORPORATED UNDER THE INDIAN COMPANIES ACT, 1956),</b> E-3, SECTOR-1, BAWANA, DELHI-110039		
<b>DATE OF REGISTRATION</b>	26/11/2012	
<b>TITLE</b>	CHOCOLATE	
<b>PRIORITY NA</b>		

<b>DESIGN NUMBER</b>	249720	
<b>CLASS</b>	12-16	
<b>1)DEERE &amp; COMPANY, A US CORPORATION OF</b> ONE JOHN DEERE PLACE, MOLINE, ILLINOIS, 61265 - 8098, USA		
<b>DATE OF REGISTRATION</b>	27/11/2012	
<b>TITLE</b>	SEAT POD FOR A WORK VEHICLE	
<b>PRIORITY NA</b>		

<b>DESIGN NUMBER</b>	249095	
<b>CLASS</b>	04-02	
<b>1)SHREE SIMANDHAR INDUSTRIES IS A PROPRIETORSHIP FIRM OF</b> 21, NEW MANU BHUVAN, BHAGAT SINGH ROAD, VILE PARLE (W) MUMBAI-400056, MAHARASHTRA INDIA		
<b>DATE OF REGISTRATION</b>	30/10/2012	
<b>TITLE</b>	HAIR BRUSH	
<b>PRIORITY NA</b>		

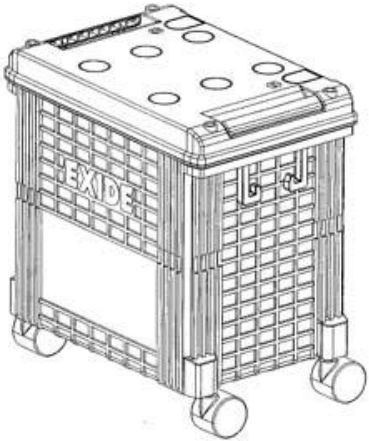
<b>DESIGN NUMBER</b>	249865	
<b>CLASS</b>	08-06	
<b>1)DIVYESHBHAI BARASIYA AN INDIAN NATIONAL SOLE PROPRIETOR OF</b> <b>SHREE TECHNOCAST AN INDIAN PROPRIETORSHIP FIRM HAVING ITS</b> <b>PRINCIPAL PLACE OF BUSINESS AT</b> AJI GIDC, SHED NO. K-1-242/5, MAL-TECH CHOWK, NR. TARBO BEARING, RAJKOT-3, GUJARAT-INDIA.		
<b>DATE OF REGISTRATION</b>	03/12/2012	
<b>TITLE</b>	HANDLE	
<b>PRIORITY NA</b>		

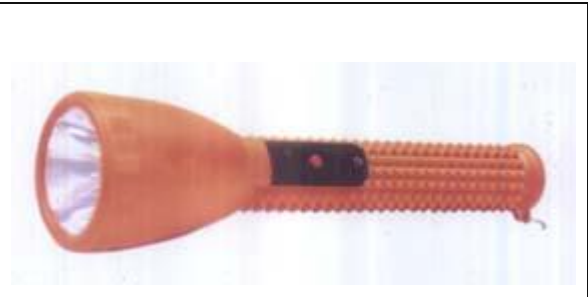
<b>DESIGN NUMBER</b>	248447	
<b>CLASS</b>	08-09	
<b>1)M/S KEMY OVERSEAS, E-43, PHASE-IV, FOCAL POINT, LUDHIANA (PUNJAB) INDIA</b> AN INDIAN PROPRIETORSHIP FIRM WHOSE PROPRIETOR IS:- TARUN GOEL BEING INDIAN NATIONALS OF THE ABOVE ADDRESS		
<b>DATE OF REGISTRATION</b>	03/10/2012	
<b>TITLE</b>	TOWER BOLT	
<b>PRIORITY NA</b>		
<b>DESIGN NUMBER</b>	248546	
<b>CLASS</b>	13-02	
<b>1)EXIDE INDUSTRIES LIMITED,</b> 59E, CHOWRINGHEE ROAD, KOLKATA-700 020, WEST BENGAL, INDIA, AN INDIAN COMPANY		
<b>DATE OF REGISTRATION</b>	05/10/2012	
<b>TITLE</b>	BATTERY FOR INVERTER	
<b>PRIORITY NA</b>		
<b>DESIGN NUMBER</b>	248425	
<b>CLASS</b>	06-01	
<b>1)UMA PLASTICS LIMITED HAVING THEIR OFFICE</b> AT 14B CAMAC STREET, 3RD FLOOR, SUITE NO. 3D, KOLKATA - 700017, WEST BENGAL, INDIA		
<b>DATE OF REGISTRATION</b>	03/10/2012	
<b>TITLE</b>	CHAIR	
<b>PRIORITY NA</b>		

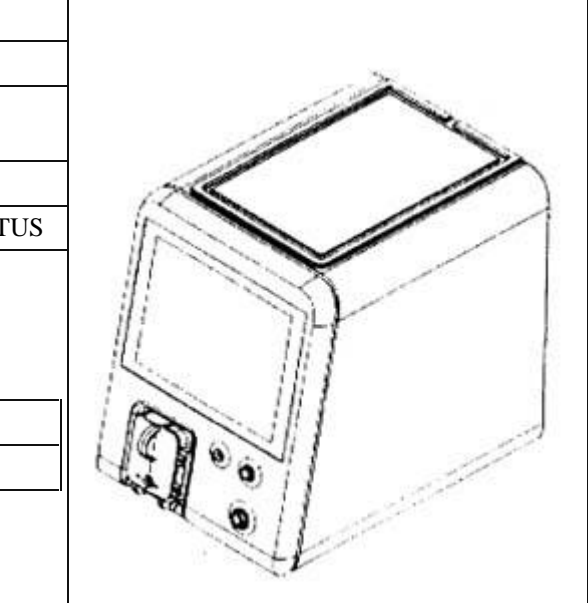
<b>DESIGN NUMBER</b>	249240		
<b>CLASS</b>	26-02		
<b>1)ANDSLITE PVT. LTD.</b> 103, F.I.E., PATPARGANJ, DELHI-110092. (INDIA).			
<b>DATE OF REGISTRATION</b>	05/11/2012		
<b>TITLE</b>	TORCH		
<b>PRIORITY NA</b>			
<b>DESIGN NUMBER</b>	249290		
<b>CLASS</b>	13-03		
<b>1)LARSEN &amp; TOUBRO LIMITED, AN INDIAN COMPANY INCORPORATED UNDER THE COMPANIES ACT, 1956 OF L &amp; T HOUSE, BALLARD ESTATE, MUMBAI 400001, STATE OF MAHARASHTRA, INDIA</b>			
<b>DATE OF REGISTRATION</b>	06/11/2012		
<b>TITLE</b>	MOULDED CASE CIRCUIT BREAKER		
<b>PRIORITY NA</b>			
<b>DESIGN NUMBER</b>	242248		
<b>CLASS</b>	24-01		
<b>1)FRITZ RUCK OPHTHALMOLOGISCHE SYSTEME GMBH</b> J LICHER STRASSE 115, 52249 ESCHWEILER, GERMANY			
<b>DATE OF REGISTRATION</b>	13/01/2012		
<b>TITLE</b>	AN OPHTHALMOLOGICAL APPARATUS		
<b>PRIORITY</b>			
<b>PRIORITY NUMBER</b>	<b>DATE</b>	<b>COUNTRY</b>	
001285407-0001	14/07/2011	EUROPEAN UNION	

<b>DESIGN NUMBER</b>	247120	
<b>CLASS</b>	08-07	
<b>1)ELSTEEL (PRIVATE) LTD ADDRESS AT</b> SPUR ROAD 2, PHASE 1, EPZ, KATUNAYAKE-11420, SRI LANKA NATIONALITY:- SRI LANKAN LEGAL STATUS: PRIVATE LIMITED COMPANY INCORPORATED IN SRI LANKA		
<b>DATE OF REGISTRATION</b>	13/08/2012	
<b>TITLE</b>	FLUSH TYPE DOOR LOCK	
<b>PRIORITY NA</b>		

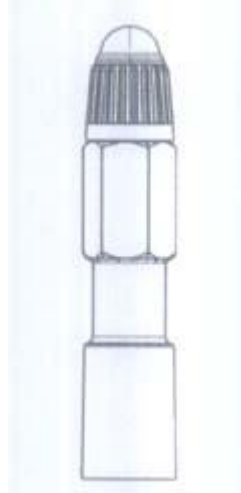
<b>DESIGN NUMBER</b>	249670	
<b>CLASS</b>	12-15	
<b>1)APOLLO TYRES LIMITED, AN INDIAN COMPANY INCORPORATED</b> <b>UNDER THE COMPANIES ACT OF 1956, REGISTERED OFFICE AT</b> 6TH FLOOR, CHERUPUSHPAM BUILDING, SHANMUGHAM ROAD, KOCHI- 682031, STATE OF KERALA, INDIA		
<b>DATE OF REGISTRATION</b>	23/11/2012	
<b>TITLE</b>	VALVE FOR VEHICLE TYRE	
<b>PRIORITY NA</b>		

<b>DESIGN NUMBER</b>	248850	
<b>CLASS</b>	26-05	
<b>1)M/S KINGO PRODUCTS (INDIA) 7512/84-C, STREET NO. 9, NEW AMAR</b> <b>NAGAR, LUDHIANA-141003 (PUNJAB) INDIA</b> AN INDIAN PROPRIETORSHIP FIRM WHOSE PROPRIETOR IS:- KULWANT SINGH BEING INDIAN NATIONALS OF THE ABOVE ADDRESS		
<b>DATE OF REGISTRATION</b>	16/10/2012	
<b>TITLE</b>	BASE FOR CONCEALED LIGHTING SYSTEM	
<b>PRIORITY NA</b>		

<b>DESIGN NUMBER</b>	249093	
<b>CLASS</b>	04-02	
<b>1)SHREE SIMANDHAR INDUSTRIES IS A PROPRIETORSHIP FIRM OF</b> 21, NEW MANU BHUVAN, BHAGAT SINGH ROAD, VILE PARLE (W) MUMBAI-400056, MAHARASHTRA INDIA		
<b>DATE OF REGISTRATION</b>	30/10/2012	
<b>TITLE</b>	HAIR BRUSH	
<b>PRIORITY NA</b>		

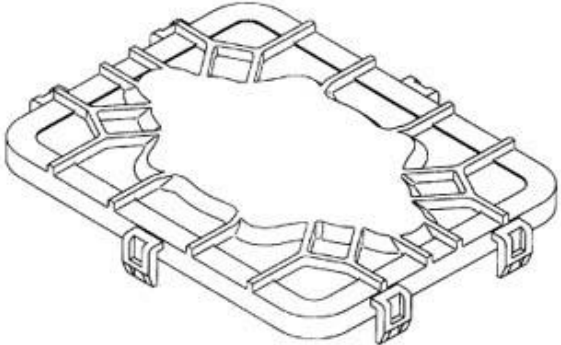
<b>DESIGN NUMBER</b>	248091	
<b>CLASS</b>	13-03	
<b>1)ASAHI KASEI CHEMICALS CORPORATION.,</b> OF 1-105, KANDA JINBOCHO, CHIYODA-KU, TOKYO 101-8101, JAPAN; NATIONALITY: JAPAN		
<b>DATE OF REGISTRATION</b>	24/09/2012	
<b>TITLE</b>	LID OF JUNCTION BOX	
<b>PRIORITY</b>		
<b>PRIORITY NUMBER</b>	<b>DATE</b>	<b>COUNTRY</b>
2012-006638	23/03/2012	JAPAN

<b>DESIGN NUMBER</b>	249849	
<b>CLASS</b>	23-04	
<b>1)BAJAJ ELECTRICALS LIMITED, A COMPANY REGISTERED IN INDIA,</b> <b>HAVING ITS REGISTERED OFFICE AT,</b> 45/47, VEER NARIMAN ROAD, MUMBAI 400 023, STATE OF MAHARASHTRA, INDIA, OF ABOVE ADDRESS		
<b>DATE OF REGISTRATION</b>	03/12/2012	
<b>TITLE</b>	AIR COOLER	
<b>PRIORITY NA</b>		

<b>DESIGN NUMBER</b>	249917	
<b>CLASS</b>	12-15	
<b>1) CEAT LIMITED, AN INDIAN COMPANY OF</b> CEAT MAHAL, 463, DR. ANNIE BESANT ROAD, WORLI, MUMBAI – 400 030, INDIA		
<b>DATE OF REGISTRATION</b>	05/12/2012	
<b>TITLE</b>	TYRE	
<b>PRIORITY NA</b>		

<b>DESIGN NUMBER</b>	248529	
<b>CLASS</b>	07-02	
<b>1) SHRI. BASANT J. BAFNA 2) SMT. DAKSHA B. BAFNA,</b> <b>PARTNERS- INDIAN NATIONAL TRADING AS JEWEL</b> <b>PLAST, HAVING ITS REGISTERED OFFICE</b> AT PLOT NO. 361/8, SHREE GANESH INDUSTRIAL ESTATE, KACHIGAM, DAMAN-396210, INDIA, OF ABOVE ADDRESS		
<b>DATE OF REGISTRATION</b>	10/10/2012	
<b>TITLE</b>	LUNCH BOX	
<b>PRIORITY NA</b>		

<b>DESIGN NUMBER</b>	248569	
<b>CLASS</b>	12-11	
<b>1) EASTMAN INDUSTRIES LIMITED, C-87, PHASE-V, FOCAL POINT,</b> <b>LUDHIANA-141010 (PUNJAB) INDIA</b> (AN INDIAN COMPANY DULY REGISTERED UNDER THE COMPANIES ACT, 1956) OF THE ABOVE ADDRESS		
<b>DATE OF REGISTRATION</b>	05/10/2012	
<b>TITLE</b>	REFLECTOR FOR BICYCLE	
<b>PRIORITY NA</b>		

<b>DESIGN NUMBER</b>	245896		
<b>CLASS</b>	25-01		
<b>1)SAINT-GOBAIN GLASS FRANCE, OF</b> LES MIROIRS, 18, AVENUE D ALSACE, 92400 COURBEVOIE, FRANCE			
<b>DATE OF REGISTRATION</b>	13/06/2012		
<b>TITLE</b>	PATTERNED GLASS		
<b>PRIORITY</b>			
<b>PRIORITY NUMBER</b>	<b>DATE</b>	<b>COUNTRY</b>	
11/5987	13/12/2011	FRANCE	
<b>DESIGN NUMBER</b>	248345		
<b>CLASS</b>	23-01		
<b>1)DR. (PROF) AJITKUMAR GORAKHANATH PATIL, INDIAN,</b> 2, SHANTA ASHISH C , IRLA LANE, VILE PARLE (WEST), MUMBAI-400 056			
<b>DATE OF REGISTRATION</b>	04/10/2012		
<b>TITLE</b>	MAGNETIC WATER TREATMENT DEVICE		
<b>PRIORITY NA</b>			
<b>DESIGN NUMBER</b>	249136		
<b>CLASS</b>	08-06		
<b>1)AMITBHAI M. CHOVIYA AND ASHISHBHAI G. GADHIYA BOTH INDIAN</b> <b>NATIONAL PARTNERS OF FORAM SALES CORPORATION AN INDIAN</b> <b>PARTNERSHIP FIRM HAVING ITS PRINCIPAL PLACE OF BUSINESS AT</b> PLOT NO. 7, PATEL IND. AREA, OPP. RIDDHI SIDDHI PARK, NEAR SANDHIYA POOL, (KOTHARIYA), RAJKOT, GUJARAT - INDIA			
<b>DATE OF REGISTRATION</b>	31/10/2012		
<b>TITLE</b>	HANDLE		
<b>PRIORITY NA</b>			





<b>DESIGN NUMBER</b>	249241	
<b>CLASS</b>	21-01	
<b>1)PLAYTONE PRODUCTS, F-4, GALI NO. 33, MAHENDRA PARK, DELHI-110033, INDIA.</b> (AN INDIAN PROPRIETORSHIP FIRM WHOSE PROPRIETOR IS :- SH. MANJEET LAL SEHGAL. AN INDIAN NATIONAL OF THE ABOVE ADDRESS		
<b>DATE OF REGISTRATION</b>	05/11/2012	
<b>TITLE</b>	TOY OIL TANKER	
<b>PRIORITY NA</b>		

<b>DESIGN NUMBER</b>	249298	
<b>CLASS</b>	28-03	
<b>1)LASER SHAVING (INDIA) PRIVATE LIMITED, A COMPANY DULY ORGANIZED UNDER THE INDIAN COMPANIES ACT, 1956 AND HAVING ITS REGISTERED OFFICE AT</b> MALHOTRA HOUSE, 6-3-1186, BEGUMPET, HYDERABAD 500 016, ANDHRA PRADESH, INDIA		
<b>DATE OF REGISTRATION</b>	07/11/2012	
<b>TITLE</b>	RAZOR HANDLE	
<b>PRIORITY NA</b>		

<b>DESIGN NUMBER</b>	244437	
<b>CLASS</b>	15-02	
<b>1)M. B. EXPORTS LIMITED</b> ADJ. KAIND CANAL BRIDGE, VILLAGE-KAIND, P.O. GHWADDI, NEAR DEHLON, LUDHIANA-MALERKOTLA ROAD, SH-11, LUDHIANA-141206, PUNJAB, INDIA		
<b>DATE OF REGISTRATION</b>	03/04/2012	
<b>TITLE</b>	FEMALE COUPLING	
<b>PRIORITY NA</b>		

<b>DESIGN NUMBER</b>	247049	
<b>CLASS</b>	06-10	
<b>1)(1). BANKIMBHAI VELJIBHAI MANVAR, (2) ALPESHBHAI HASMUKHBHAI PARIKH (3) VINESHBHAI RATILAL DADHANIYA (4). MITKUMAR KISHORBHAI DEPANI., ALL INDIAN NATIONAL PARTNERS OF M/S. BARRY CREATION., AN INDIAN PARTNERSHIP FIRM., HAVING ITS PRINCIPLE PLACE OF BUSINESS AT, 901, RAVI TOWER, OPP. PARIMAL SCHOOL, KALAWAD ROAD, RAJKOT-360 004. GUJARAT-INDIA.</b>		
<b>DATE OF REGISTRATION</b>	08/08/2012	
<b>TITLE</b>	CURTAIN BLIND	
<b>PRIORITY NA</b>		
<b>DESIGN NUMBER</b>	247106	
<b>CLASS</b>	25-01	
<b>1)MR. CHANDRAKANT S. MANIYAL AN INDIVIDUAL - INDIAN RESIDENT OF, 1, LAXMI NARAYAN COLONY, THANKAR PADA, AGRA ROAD, KALYAN(W)-421301. MAHARASHTRA, INDIA</b>		
<b>DATE OF REGISTRATION</b>	13/08/2012	
<b>TITLE</b>	SLAB COVER	
<b>PRIORITY NA</b>		
<b>DESIGN NUMBER</b>	249681	
<b>CLASS</b>	01-01	
<b>1)M/S. SWEETON FOODS PVT. LTD., (A COMPANY DULY INCORPORATED UNDER THE INDIAN COMPANIES ACT, 1956), E-3, SECTOR-1, BAWANA, DELHI-110039</b>		
<b>DATE OF REGISTRATION</b>	26/11/2012	
<b>TITLE</b>	CHOCOLATE	
<b>PRIORITY NA</b>		

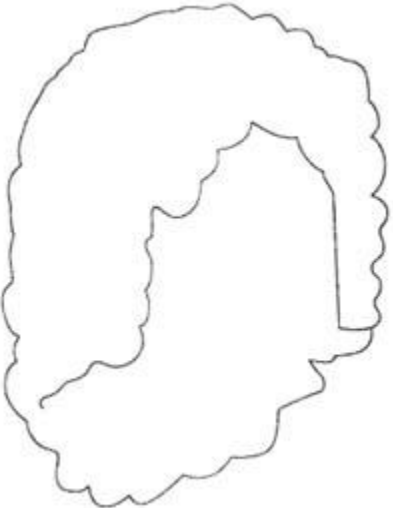
<b>DESIGN NUMBER</b>	249000		
<b>CLASS</b>	08-06		
<b>1)(1) PARESHBHAI V. BHALIYA (2) CHANDRIKABEN P. BHALIYA (3) RAJESH O. KOTADIA (4) GHANSHYAM O. KOTADIA ALL INDIAN NATIONAL PARTNERS OF MARUTI METALS AN INDIAN PARTNERSHIP FIRM HAVING ITS PRINCIPAL PLACE OF BUSINESS AT</b> SOMNATH ESTATE, SHOP NO. 3, NEAR DWARKADHISH ESTATE, VIRANI AGHAT, DHEBAR ROAD(SOUTH), RAJKOT-2, GUJARAT-INDIA			
<b>DATE OF REGISTRATION</b>	25/10/2012		
<b>TITLE</b>	HANDLE		
<b>PRIORITY NA</b>			
<b>DESIGN NUMBER</b>	248067		
<b>CLASS</b>	08-06		
<b>1)(1) PARESHBHAI V. BHALIYA (2) CHANDRIKABEN P. BHALIYA (3) RAJESH O. KOTADIA (4) GHANSHYAM O. KOTADIA ALL INDIAN NATIONAL PARTNERS OF MARUTI METALS AN INDIAN PARTNERSHIP FIRM HAVING ITS PRINCIPAL PLACE OF BUSINESS</b> AT SOMNATH ESTATE, SHOP NO. 3, NEAR DWARKADHISH ESTATE, VIRANI AGHAT, DHEBAR ROAD(SOUTH), RAJKOT-2, GUJARAT-INDIA			
<b>DATE OF REGISTRATION</b>	20/09/2012		
<b>TITLE</b>	HANDLE		
<b>PRIORITY NA</b>			
<b>DESIGN NUMBER</b>	241684		
<b>CLASS</b>	21-01		
<b>1)LEGO A/S</b> AASTVEJ 1, DK-7190 BILLUND, DENMARK			
<b>DATE OF REGISTRATION</b>	23/12/2011		
<b>TITLE</b>	TOY BUILDING BLOCK		
<b>PRIORITY</b>			
<b>PRIORITY NUMBER</b>	<b>DATE</b>	<b>COUNTRY</b>	
611574101	30/06/2011	WIPO	

<b>DESIGN NUMBER</b>	249851	
<b>CLASS</b>	11-01	
<b>1)LILI DIAMONDS OF</b> THE DIAMOND EXCHANGE-MACCABI BUILDING, 1 JABOTINSKY STREET, RAMAT GAN 52520, ISRAEL, AN ISRAELI COMPANY		
<b>DATE OF REGISTRATION</b>	03/12/2012	
<b>TITLE</b>	GEMSTONE	
<b>PRIORITY</b>		
<b>PRIORITY NUMBER</b>	<b>DATE</b>	<b>COUNTRY</b>
53343	01/11/2012	ISRAEL

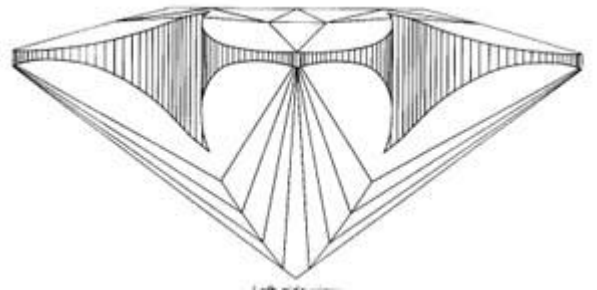



<b>DESIGN NUMBER</b>	248582	
<b>CLASS</b>	02-04	
<b>1)M/S VEEKESY ELASTOMERS PVT LTD, AN INDIAN COMPANY</b> <b>REGISTERED UNDER COMPANIES ACT, 1956, HAVING ITS REGISTERED</b> <b>OFFICE AT</b> NH-17, NEAR STEEL COMPLEX, KOLATHARA P.O, KOZHIKODE, PIN-673655, KERALA, INDIA		
<b>DATE OF REGISTRATION</b>	05/10/2012	
<b>TITLE</b>	SOLE OF FOOTWEAR	
<b>PRIORITY NA</b>		



<b>DESIGN NUMBER</b>	248693	
<b>CLASS</b>	23-01	
<b>1)A. O. SMITH INDIA WATER HEATING PRIVATE LIMITED, A</b> <b>COMPANY INCORPORATED UNDER THE LAWS OF INDIA, OF</b> PLOT NO. 300, KIADB INDUSTRIAL AREA PHASE II, HAROHALLI, KANAKAPURA TALUK, RAMANAGARA DISTRICT, KARNATAKA 562 112, INDIA		
<b>DATE OF REGISTRATION</b>	17/10/2012	
<b>TITLE</b>	WATER PURIFIER	
<b>PRIORITY NA</b>		



<b>DESIGN NUMBER</b>	248178	
<b>CLASS</b>	14-03	
<b>1)CHINTAN PANKAJ KOTHARI. (INDIAN NATIONAL)</b> OF 1A, ANKUR APARTMENT, 51 JUHU LANE, ANDHERI (WEST), MUMBAI-400058., MAHARASHTRA, INDIA.		
<b>DATE OF REGISTRATION</b>	26/09/2012	
<b>TITLE</b>	TELEPHONE JACK	
<b>PRIORITY NA</b>		

<b>DESIGN NUMBER</b>	249155	
<b>CLASS</b>	21-01	
<b>1)DR. ING. H.C.F. PORSCHE AKTIENGESELLSCHAFT, A GERMAN COMPANY</b> OF PORSCHEPLATZ 1, 70435 STUTTGART, GERMANY		
<b>DATE OF REGISTRATION</b>	01/11/2012	
<b>TITLE</b>	TOY CAR	
<b>PRIORITY NA</b>		

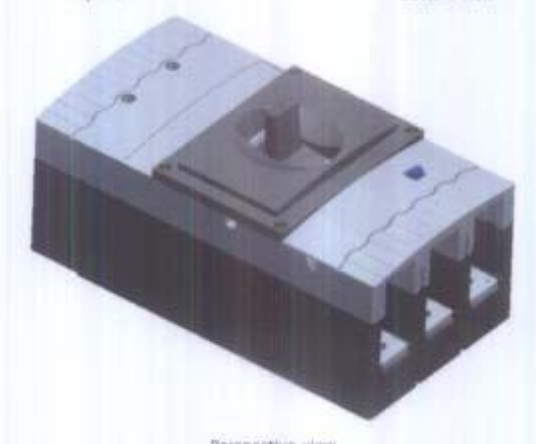
<b>DESIGN NUMBER</b>	249288	
<b>CLASS</b>	13-03	
<b>1)LARSEN &amp; TOUBRO LIMITED, AN INDIAN COMPANY INCORPORATED UNDER THE COMPANIES ACT, 1956 OF</b> L & T HOUSE, BALLARD ESTATE, MUMBAI 400001, STATE OF MAHARASHTRA, INDIA		
<b>DATE OF REGISTRATION</b>	06/11/2012	
<b>TITLE</b>	MOULDED CASE CIRCUIT BREAKER	
<b>PRIORITY NA</b>		

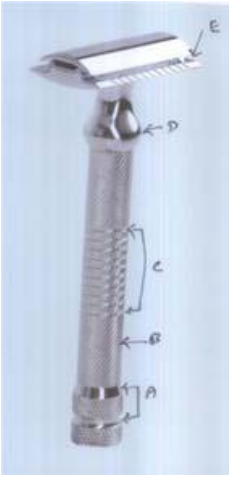
<b>DESIGN NUMBER</b>	247181	
<b>CLASS</b>	28-03	
<b>1)MADHAV METAL INDUSTRIES, INDIAN PROPRIETORSHIP FIRM HAVING PRINCIPAL PLACE OF BUSINESS AT 361/4, 49-ROAD, SHANKARTEKRI UDHYOG NAGAR, JAMNAGAR-361004, GUJARAT, INDIA AND HAVING PROPRIETOR DIPESHBHAI DHIRAJLAL SABHAYA, RESIDING AT "MADHAV VRUVD"• , JAY SOCIETY STREET NO. 03, BAPASITARAM CHOWK, B/H. KRUSHNA NAGAR, JAMNAGAR, INDIAN NATIONALS</b>		
<b>DATE OF REGISTRATION</b>	16/08/2012	
<b>TITLE</b>	RAZOR	
<b>PRIORITY NA</b>		

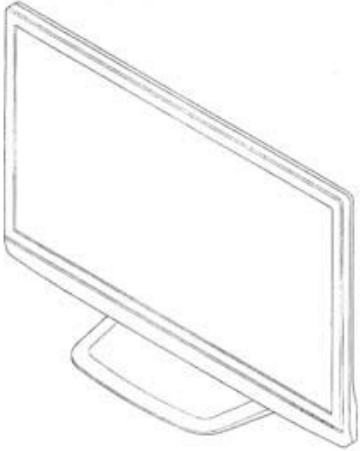
<b>DESIGN NUMBER</b>	249461	
<b>CLASS</b>	14-03	
<b>1)LG ELECTRONICS INC. 20 YEOUIDO - DONG, YEONGDEUNGPO - GU, SEOUL 150 - 721, REPUBLIC OF KOREA A CORPORATION INCORPORATED UNDER THE LAWS OF THE REPUBLIC OF KOREA</b>		
<b>DATE OF REGISTRATION</b>	14/11/2012	
<b>TITLE</b>	TELEVISION RECEIVER	
<b>PRIORITY NA</b>		

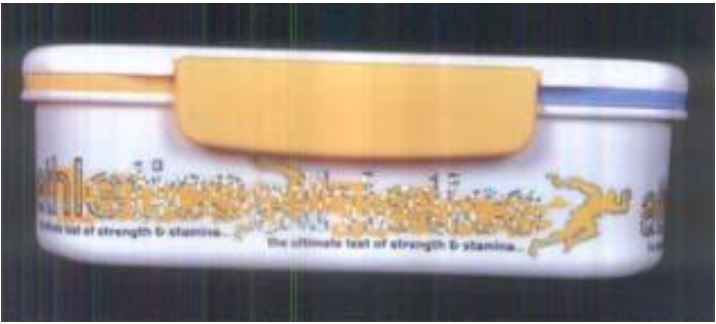
<b>DESIGN NUMBER</b>	249627	
<b>CLASS</b>	07-02	
<b>1)1) SHRI. BASANT J. BAFNA 2) SMT. DAKSHA B. BAFNA, PARTNERS-INDIAN NATIONAL TRADING AS JEWEL PLAST, HAVING ITS REGISTERED OFFICE AT PLOT NO. 361/8, SHREE GANESH INDUSTRIAL ESTATE, KACHIGAM, DAMAN-396210, INDIA, OF ABOVE ADDRESS</b>		
<b>DATE OF REGISTRATION</b>	21/11/2012	
<b>TITLE</b>	LUNCH BOX	
<b>PRIORITY NA</b>		

<b>DESIGN NUMBER</b>	249696	
<b>CLASS</b>	31-00	
<b>1)M/S. V-GUARD INDUSTRIES LTD., AN INDIAN COMPANY INCORPORATED UNDER THE COMPANIES ACT OF 1956 WHOSE ADDRESS IS</b> 33/2905 F, VENNALA HIGH SCHOOL ROAD, VENNALA, KOCHI - 682028, KERALA STATE, INDIA		
<b>DATE OF REGISTRATION</b>	26/11/2012	
<b>TITLE</b>	BODY OF MIXER	
<b>PRIORITY NA</b>		

<b>DESIGN NUMBER</b>	249757	
<b>CLASS</b>	12-11	
<b>1)LA SOVEREIGN BICYCLES PRIVATE LIMITED OF 168-B, INDUSTRIAL ESTATE, LUDHIANA-141003 (PUNJAB), INDIA,</b> AN INDIAN PRIVATE LIMITED COMPANY WHOSE MANAGING DIRECTOR IS ROHIT KALRA, AN INDIAN NATIONAL OF ABOVE ADDRESS		
<b>DATE OF REGISTRATION</b>	29/11/2012	
<b>TITLE</b>	BICYCLE FRAME	
<b>PRIORITY NA</b>		

<b>DESIGN NUMBER</b>	249879	
<b>CLASS</b>	12-11	
<b>1)LA SOVEREIGN BICYCLES PRIVATE LIMITED OF 168-B, INDUSTRIAL ESTATE, LUDHIANA-141003 (PUNJAB), INDIA</b> AN INDIAN PRIVATE LIMITED COMPANY WHOSE MANAGING DIRECTOR IS ROHIT KALRA, AN INDIAN NATIONAL OF ABOVE ADDRESS		
<b>DATE OF REGISTRATION</b>	04/12/2012	
<b>TITLE</b>	BICYCLE FRAME	
<b>PRIORITY NA</b>		

<b>DESIGN NUMBER</b>	248567	
<b>CLASS</b>	12-11	
<b>1)EASTMAN INDUSTRIES LIMITED, C-87, PHASE-V, FOCAL POINT, LUDHIANA-141010 (PUNJAB) INDIA</b> (AN INDIAN COMPANY DULY REGISTERED UNDER THE COMPANIES ACT, 1956) OF THE ABOVE ADDRESS		
<b>DATE OF REGISTRATION</b>	05/10/2012	
<b>TITLE</b>	FOOT REST FOR STUNT BICYCLE	
<b>PRIORITY NA</b>		
<b>DESIGN NUMBER</b>	249091	
<b>CLASS</b>	04-02	
<b>1)SHREE SIMANDHAR INDUSTRIES IS A PROPRIETORSHIP FIRM OF</b> 21, NEW MANU BHUVAN, BHAGAT SINGH ROAD, VILE PARLE (W) MUMBAI-400056, MAHARASHTRA INDIA		
<b>DATE OF REGISTRATION</b>	30/10/2012	
<b>TITLE</b>	HAIR BRUSH	
<b>PRIORITY NA</b>		
<b>DESIGN NUMBER</b>	245670	
<b>CLASS</b>	02-02	
<b>1)KIRAN KNIT &amp; GARMENTS PVT. LTD., 246, A-Z INDUSTRIAL ESTATE, GANPATRAO KADAM ROAD, NEXT TO PENNINSULA CORPORATE PARK, LOWER PAREL, MUMBAI-400 036. (INDIA)</b>		
<b>DATE OF REGISTRATION</b>	01/06/2012	
<b>TITLE</b>	SHORTS	
<b>PRIORITY NA</b>		



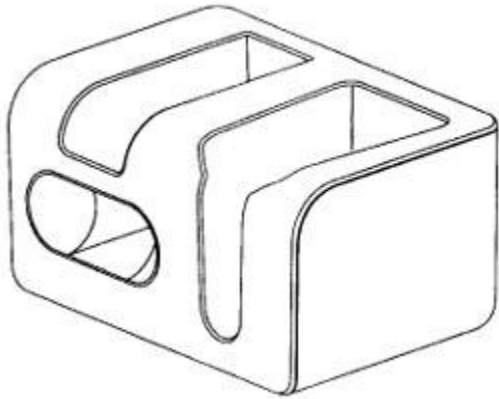

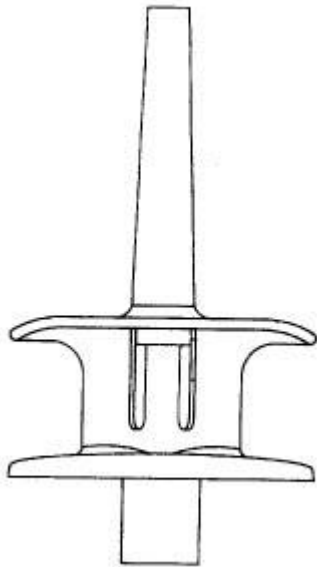
<b>DESIGN NUMBER</b>	248195	
<b>CLASS</b>	13-02	
<b>1)KAZ EUROPE SA, PLACE CHAUDERON 18, CH-1003, LAUSANNE, SWITZERLAND</b>		
<b>DATE OF REGISTRATION</b>	26/09/2012	
<b>TITLE</b>	THERMOMETER CHARGING DOCK	
<b>PRIORITY NA</b>		

<b>DESIGN NUMBER</b>	241353	
<b>CLASS</b>	24-04	
<b>1)R5 PHARMACEUTICALS LIMITED UNITED KINGDOM, BIOCITY NOTTINGHAM, PENNYFOOT STREET, NOTTINGHAM, NOTTINGHAMSHIRE NG1 1GF, UNITED KINGDOM</b>		
<b>DATE OF REGISTRATION</b>	09/12/2011	
<b>TITLE</b>	BUCCAL DELIVERY DEVICE	
<b>PRIORITY</b>		
<b>PRIORITY NUMBER</b>	<b>DATE</b>	<b>COUNTRY</b>
001885922-0001	01/07/2011	OHIM

<b>DESIGN NUMBER</b>	244150	
<b>CLASS</b>	12-11	
<b>1)HERO CYCLES LIMITED HERO NAGAR, G. T. ROAD, LUDHIANA-141003, PUNJAB, INDIA,</b>		
<b>DATE OF REGISTRATION</b>	27/03/2012	
<b>TITLE</b>	BICYCLE	
<b>PRIORITY NA</b>		

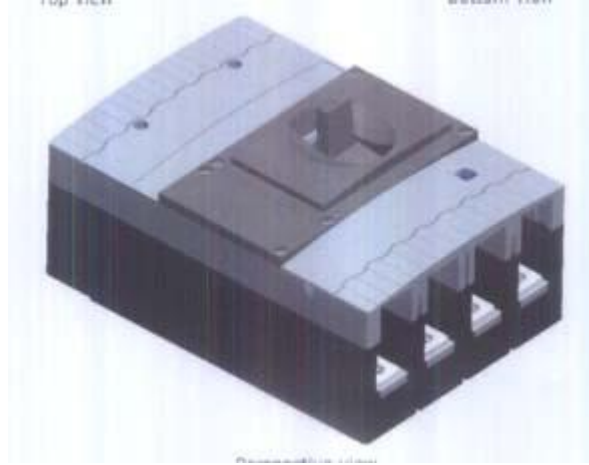
<b>DESIGN NUMBER</b>	249226	
<b>CLASS</b>	26-02	
<b>1) LEADING POINT POWERTRONICS PVT. LTD., A-11, OKHLA INDUSTRIAL AREA, PHASE-1, NEW DELHI-110020. (INDIA). (AN INDIAN COMPANY DULY REGISTERED UNDER THE COMPANIES ACT, 1956)</b>		
<b>DATE OF REGISTRATION</b>	05/11/2012	
<b>TITLE</b>	STUDY LAMP	
<b>PRIORITY NA</b>		

<b>DESIGN NUMBER</b>	249289	
<b>CLASS</b>	13-03	
<b>1) LARSEN &amp; TOUBRO LIMITED, AN INDIAN COMPANY INCORPORATED UNDER THE COMPANIES ACT, 1956 OF L &amp; T HOUSE, BALLARD ESTATE, MUMBAI 400 001, STATE OF MAHARASHTRA, INDIA</b>		
<b>DATE OF REGISTRATION</b>	06/11/2012	
<b>TITLE</b>	MOULDED CASE CIRCUIT BREAKER	
<b>PRIORITY NA</b>		

<b>DESIGN NUMBER</b>	247492	
<b>CLASS</b>	08-06	
<b>1)(1) MILANBHAI MAGANBHAI GAJERA (2) MANOJBHAI BABUBHAI MUNGPARA., BOTH INDIAN NATIONAL PARTNERS OF M/S. ANJANI ENTERPRISE., AN INDIAN PARTNERSHIP FIRM., HAVING ITS PRINCIPAL PLACE OF BUSINESS AT, SHIVRAM IND. AREA, NR. HARSODA FOUNDRY, B/H. RIDDHI SIDDHI SOCIETY, SANDHIYA POOL, N.H. 8, RAJKOT-360 002. GUJARAT-INDIA.</b>		
<b>DATE OF REGISTRATION</b>	31/08/2012	
<b>TITLE</b>	HANDLE	
<b>PRIORITY NA</b>		

<b>DESIGN NUMBER</b>	249469	
<b>CLASS</b>	09-03	
<b>1)EMAMI LIMITED, AN INDIAN COMPANY HAVING ITS REGISTERED OFFICE AT</b> EMAMI TOWER , 687 ANANDAPUR, EM BYPASS, KOLKATA 700017, WEST BENGAL, INDIA.		
<b>DATE OF REGISTRATION</b>	14/11/2012	
<b>TITLE</b>	CONTAINER	
<b>PRIORITY NA</b>		
<b>DESIGN NUMBER</b>	249892	
<b>CLASS</b>	09-01	
<b>1)PEARL POLYMERS LIMITED, OF</b> 204, ROHIT HOUSE, 3, TOLSTOY MARG, NEW DELHI-110 001, INDIA, A COMPANY INCORPORATED UNDER THE COMPANIES ACT, 1956, OF THE ABOVE ADDRESS		
<b>DATE OF REGISTRATION</b>	04/12/2012	
<b>TITLE</b>	JAR	
<b>PRIORITY NA</b>		
<b>DESIGN NUMBER</b>	248568	
<b>CLASS</b>	12-11	
<b>1)EASTMAN INDUSTRIES LIMITED, C-87, PHASE-V, FOCAL POINT, LUDHIANA-141010 (PUNJAB) INDIA</b> (AN INDIAN COMPANY DULY REGISTERED UNDER THE COMPANIES ACT, 1956) OF THE ABOVE ADDRESS		
<b>DATE OF REGISTRATION</b>	05/10/2012	
<b>TITLE</b>	CHAIN WHEEL FOR BICYCLE	
<b>PRIORITY NA</b>		

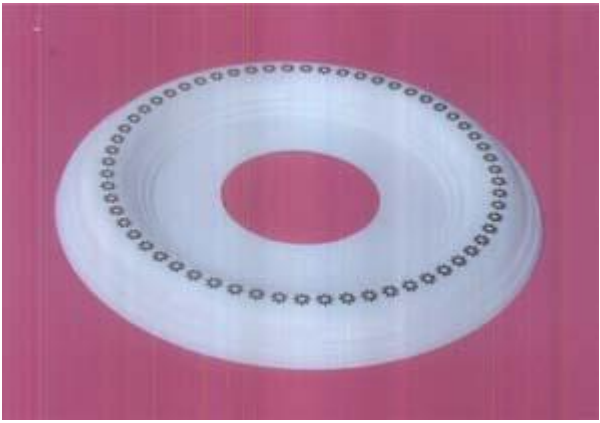
<b>DESIGN NUMBER</b>	248849	
<b>CLASS</b>	26-05	
<b>1)M/S KINGO PRODUCTS (INDIA) 7512/84-C, STREET NO. 9, NEW AMAR NAGAR, LUDHIANA-141003 (PUNJAB) INDIA</b> AN INDIAN PROPRIETORSHIP FIRM WHOSE PROPRIETOR IS:- KULWANT SINGH BEING INDIAN NATIONALS OF THE ABOVE ADDRESS		
<b>DATE OF REGISTRATION</b>	16/10/2012	
<b>TITLE</b>	COVER FOR CONCEALED LIGHTING SYSTEM	
<b>PRIORITY NA</b>		

<b>DESIGN NUMBER</b>	249206	
<b>CLASS</b>	15-05	
<b>1)PRADEEPKUMAR NANDLAL DHOOT, INDIAN NATIONAL OF GANGAPURWALA, 2275 ADAT BAZAR, AHMEDNAGAR-414 001, MAHARASHTRA, INDIA.</b>		
<b>DATE OF REGISTRATION</b>	02/11/2012	
<b>TITLE</b>	WASHING MACHINE	
<b>PRIORITY NA</b>		

<b>DESIGN NUMBER</b>	249286	
<b>CLASS</b>	13-03	
<b>1)LARSEN &amp; TOUBRO LIMITED, AN INDIAN COMPANY INCORPORATED UNDER THE COMPANIES ACT, 1956 OF L &amp; T HOUSE, BALLARD ESTATE, MUMBAI 400001, STATE OF MAHARASHTRA, INDIA</b>		
<b>DATE OF REGISTRATION</b>	06/11/2012	
<b>TITLE</b>	MOULDED CASE CIRCUIT BREAKER	
<b>PRIORITY NA</b>		

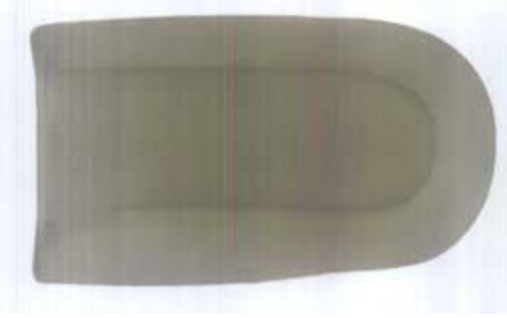
<b>DESIGN NUMBER</b>	249426	
<b>CLASS</b>	02-04	
<b>1)RAJ KUMAR GROVER, SOLE PROPRIETOR OF PHARMATECH DISTRIBUTORS WHOSE ADDRESS IS</b> S-12, SHIVAJI PARK MARKET, PUNJABI BAGH, NEW DELHI-110026, INDIA, AN INDIAN NATIONAL OF ABOVE ADDRESS		
<b>DATE OF REGISTRATION</b>	12/11/2012	
<b>TITLE</b>	HEEL CUP FOR FOOTWEAR	
<b>PRIORITY NA</b>		

<b>DESIGN NUMBER</b>	249693	
<b>CLASS</b>	13-01	
<b>1)NAKAYAMA IRON WORKS, LTD.</b> 2246-1 AMAGU, ASAHI-MACHI, TAKEO CITY, SAGA PREF. 843-0001, JAPAN, A COMPANY OF JAPAN		
<b>DATE OF REGISTRATION</b>	26/11/2012	
<b>TITLE</b>	HYDROELECTRIC POWER GENERATING APPARATUS	
<b>PRIORITY</b>		
<b>PRIORITY NUMBER</b>	<b>DATE</b>	<b>COUNTRY</b>
2012-014840	22/06/2012	JAPAN

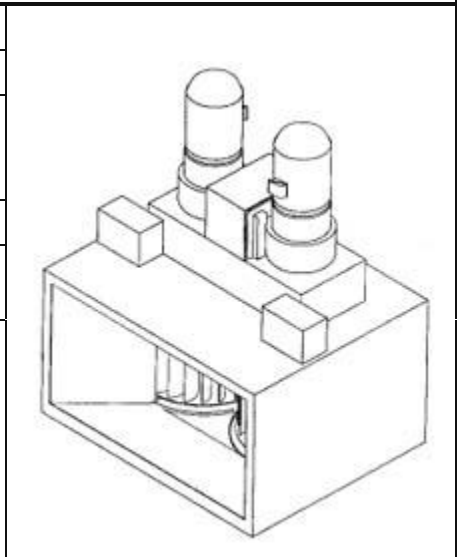

<b>DESIGN NUMBER</b>	242508	
<b>CLASS</b>	05-06	
<b>1)LG HAUSYS, LTD.,</b> 20, YEOUIDO-DONG, YEONGDEUNGPO-GU, SEOUL 150-721, REPUBLIC OF KOREA		
<b>DATE OF REGISTRATION</b>	25/01/2012	
<b>TITLE</b>	SHEET FOR VEHICLE SEATS	
<b>PRIORITY</b>		
<b>PRIORITY NUMBER</b>	<b>DATE</b>	<b>COUNTRY</b>
KR 30-2011-0035442	25/08/2011	REPUBLIC OF KOREA

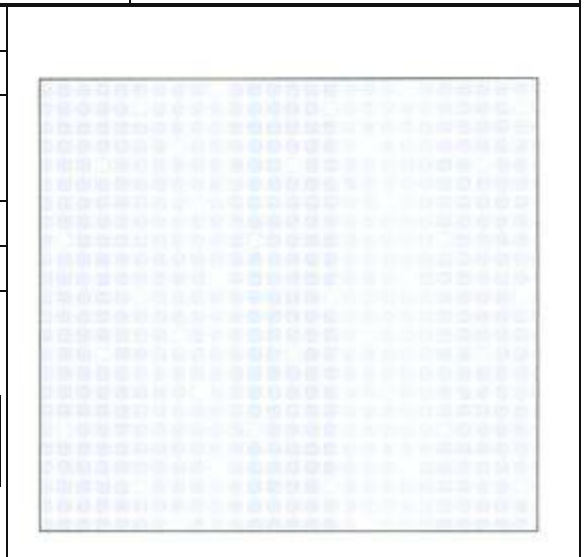

<b>DESIGN NUMBER</b>	248894	
<b>CLASS</b>	07-01	
<b>1)RAVISSANT PRIVATE LIMITED, AN INDIAN COMPANY, OF 50-51, COMMERCIAL COMPLEX, NEW FRIENDS COLONY, NEW DELHI-110065, INDIA</b>		
<b>DATE OF REGISTRATION</b>	19/10/2012	
<b>TITLE</b>	DISH WITH LID	
<b>PRIORITY NA</b>		

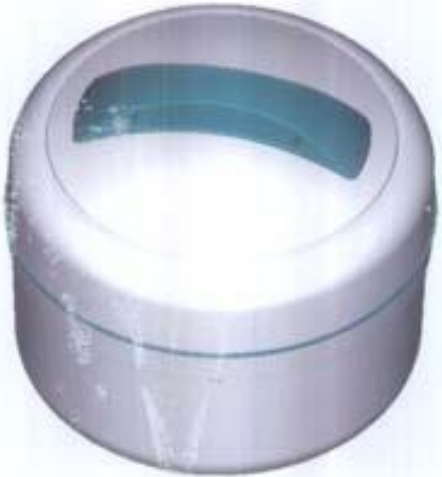
<b>DESIGN NUMBER</b>	249088	
<b>CLASS</b>	07-02	
<b>1)RISHABH PLAST INDUSTRIES AN INDIAN COMPANY HAVING HIS ADDRESS AT 302, 3RD FLOOR, RAGHUVIR, OPP. PRABODHANKAR THAKARE HALL, CHASMUNDA CIRCLE, BORIVALI (W), MUMBAI, MAHARASHTRA (INDIA), PIN-400092</b>		
<b>DATE OF REGISTRATION</b>	30/10/2012	
<b>TITLE</b>	CASSEROLE	
<b>PRIORITY NA</b>		

<b>DESIGN NUMBER</b>	245567	
<b>CLASS</b>	15-06	
<b>1)G. RADHAKRISHNAN, S/O. GURUSAMY, AN INDIAN NATIONAL RESIDING AT 10/23A, SHRUTHI ARCADE, AYYASAMY NAGAR, THOTTIPALAYAM, CHINNIYAMPALAYAM POST, COIMBATORE-641062, TAMIL NADU, INDIA</b>		
<b>DATE OF REGISTRATION</b>	24/05/2012	
<b>TITLE</b>	TEXTILE MACHINERY DOOM SLUB PANEL	
<b>PRIORITY NA</b>		

<b>DESIGN NUMBER</b>	241533	
<b>CLASS</b>	09-01	
<b>1)GOUSSON-CONSULTADORIA E MARKETING S.A.R.L., 2 RUE JOSEPH HACKIN., L-1746 LUXEMBOURG, (LUXEMBOURG),</b>		
<b>DATE OF REGISTRATION</b>	16/12/2011	
<b>TITLE</b>	BOTTLE FOR PERFUMES	
<b>PRIORITY</b>		
<b>PRIORITY NUMBER</b>	<b>DATE</b>	<b>COUNTRY</b>
001882184	13/06/2011	OHIM

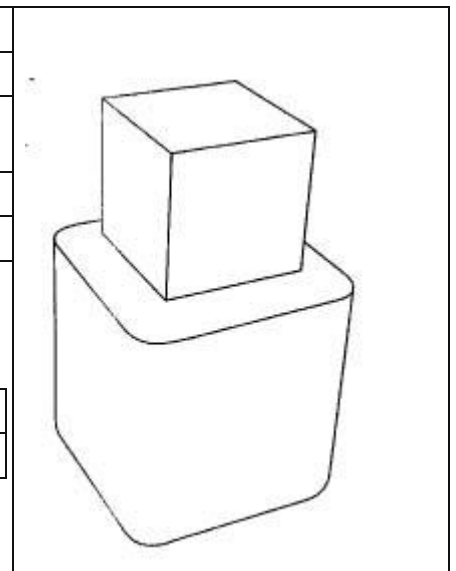



<b>DESIGN NUMBER</b>	247333	
<b>CLASS</b>	12-16	
<b>1)TVS MOTOR COMPANY LIMITED, AN INDIAN COMPANY INCORPORATED UNDER THE COMPANIES ACT, 1956, HAVING ITS REGISTERED OFFICE AT JAYALAKSHMI ESTATE, 29 (OLD NO. 8) HADDOWS ROAD, CHENNAI – 600 006, TAMIL NADU, INDIA</b>		
<b>DATE OF REGISTRATION</b>	24/08/2012	
<b>TITLE</b>	COVER HANDLE	
<b>PRIORITY NA</b>		

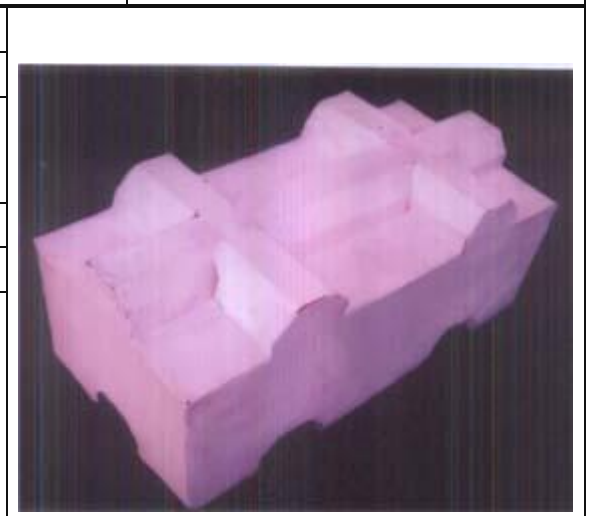

<b>DESIGN NUMBER</b>	249761	
<b>CLASS</b>	25-01	
<b>1)ANIL KUMAR TIWARI, S/O GOVIND PRASAD TIWARI, BEHIND GAYATRI MANDIR, SUBJIMANDI, BARAN, PIN-325205, RAJASTHAN- INDIA, AN INDIAN NATIONAL</b>		
<b>DATE OF REGISTRATION</b>	29/11/2012	
<b>TITLE</b>	BRICK	
<b>PRIORITY NA</b>		



<b>DESIGN NUMBER</b>	249867	
<b>CLASS</b>	08-06	
<b>1)(1) PARESHBHAI V. BHALIYA (2) CHANDRIKABEN P. BHALIYA (3) RAJESH O. KOTADIA (4) GHANSHYAM O. KOTADIA ALL INDIAN NATIONAL PARTNERS OF MARUTI METALS AN INDIAN PARTNERSHIP FIRM HAVING ITS PRINCIPAL PLACE OF BUSINESS AT</b> SOMNATH ESTATE, SHOP NO. 3, NEAR DWARKADHISH ESTATE, VIRANI AGHAT, DHEBAR ROAD(SOUTH), RAJKOT-2, GUJARAT-INDIA		
<b>DATE OF REGISTRATION</b>	03/12/2012	
<b>TITLE</b>	HANDLE	
<b>PRIORITY NA</b>		

<b>DESIGN NUMBER</b>	245979	
<b>CLASS</b>	10-05	
<b>1)TLV CO., LTD., A JAPANESE CORPORATION</b> OF 881 NAGASUNA, NOGUCHICHO, KAKOGAWA-SHI, HYOGO 6758511, JAPAN		
<b>DATE OF REGISTRATION</b>	14/06/2012	
<b>TITLE</b>	VIBRATION AND TEMPERATURE DETECTION TRANSMITTER	
<b>PRIORITY NA</b>		

<b>DESIGN NUMBER</b>	248451	
<b>CLASS</b>	07-02	
<b>1)M/S GAURAV METAL INDUSTRIES, BEHIND ISHAR SAR GURDWARA, BYE PASS, VILL. PANJ DHERA, PHILLAUR-144410, JALANDHAR (PUNJAB) INDIA</b> AN INDIAN PROPRIETORSHIP FIRM WHOSE PROPRIETOR IS :-HARISH KUMAR GUPTA BEING INDIAN NATIONALS OF THE ABOVE ADDRESS		
<b>DATE OF REGISTRATION</b>	03/10/2012	
<b>TITLE</b>	HANDLE FOR FRY-PAN	
<b>PRIORITY NA</b>		



<b>DESIGN NUMBER</b>	248335	
<b>CLASS</b>	02-02	
<b>1)X &amp; O CLOTHING PVT. LTD., (AN INDIAN PRIVATE LIMITED COMPANY REGISTERED UNDER THE INDIAN COMPANIES ACT, 1956),</b> OF 3, THAKUR COMPOUND, 1ST FLOOR, NEXT TO ABB, USV LTD., LANE, OFF. B.S. DEVSHI MARG, GOVANDI(EAST), MUMBAI-400088, MAHARASHTRA, INDIA		
<b>DATE OF REGISTRATION</b>	03/10/2012	
<b>TITLE</b>	GARMENT	
<b>PRIORITY NA</b>		

<b>DESIGN NUMBER</b>	248379	
<b>CLASS</b>	02-99	
<b>1)LIN YONGJIAN, AN INDIVIDUAL AND NATIONALITY OF CHINA HAVING ADDRESS</b> NO. 43 OF LONGQUAN ROAD, YANGDAI VILLAGE, CHENDAI COUNTY, JINJIANG CITY 362200, FUFIAN PROVINCE, CHINA		
<b>DATE OF REGISTRATION</b>	05/10/2012	
<b>TITLE</b>	SHOE SOLE	
<b>PRIORITY NA</b>		

<b>DESIGN NUMBER</b>	249215	
<b>CLASS</b>	08-06	
<b>1)NIKUNJBHAI R. BARASIYA AN INDIAN NATIONAL SOLE PROPRIETOR OF MEGA CAPS INDUSTRIES AN INDIAN PROPRIETORSHIP FIRM HAVING ITS PRINCIPAL PLACE OF BUSINESS AT</b> ABOVE BAJARANG PAN, 4, PATEL NAGAR, 80 FEET ROAD, RAJKOT, GUJARAT-INDIA		
<b>DATE OF REGISTRATION</b>	02/11/2012	
<b>TITLE</b>	HANDLE	
<b>PRIORITY NA</b>		

<b>DESIGN NUMBER</b>	249287
<b>CLASS</b>	13-03
<b>1) LARSEN &amp; TOUBRO LIMITED, AN INDIAN COMPANY INCORPORATED UNDER THE COMPANIES ACT, 1956 OF L &amp; T HOUSE, BALLARD ESTATE, MUMBAI 400001, STATE OF MAHARASHTRA, INDIA</b>	
<b>DATE OF REGISTRATION</b>	06/11/2012
<b>TITLE</b>	MOULDED CASE CIRCUIT BREAKER
<b>PRIORITY NA</b>	

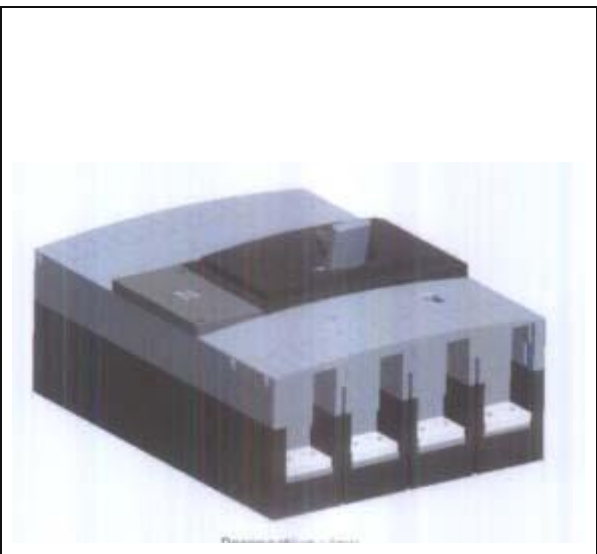

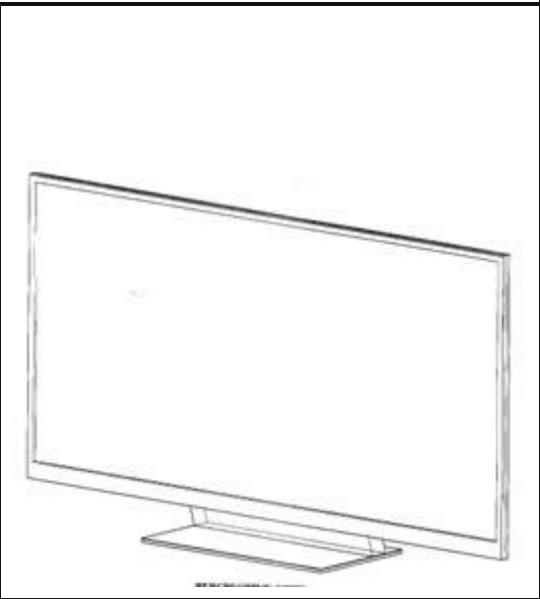

<b>DESIGN NUMBER</b>	242042	
<b>CLASS</b>	14-03	
<b>1) LG ELECTRONICS INC. 20 YEOUIDO-DONG YEONGDEUNGPO-GU SEOUL 150-721 REPUBLIC OF KOREA</b>		
<b>DATE OF REGISTRATION</b>	03/01/2012	
<b>TITLE</b>	TELEVISION RECEIVER	
<b>PRIORITY</b>		
<b>PRIORITY NUMBER</b>	<b>DATE</b>	<b>COUNTRY</b>
30-2011-0029485	15/07/2011	REPUBLIC OF KOREA



<b>DESIGN NUMBER</b>	247112	
<b>CLASS</b>	12-15	
<b>1) MRF LIMITED (AN INDIAN COMPANY), MRF LIMITED, 124 GREAMS ROAD, CHENNAI 600 006, TAMIL NADU, INDIA</b>		
<b>DATE OF REGISTRATION</b>	13/08/2012	
<b>TITLE</b>	TYRE FOR AUTOMOBILE	
<b>PRIORITY NA</b>		





<b>DESIGN NUMBER</b>	249635		
<b>CLASS</b>	12-16		
<b>1)HONDA MOTOR CO., LTD., A JAPANESE CORPORATION, OF 1-1, MINAMI-AOYAMA 2-CHOME, MINATO-KU, TOKYO, JAPAN</b>			
<b>DATE OF REGISTRATION</b>	22/11/2012		
<b>TITLE</b>	STEERING WHEEL FOR AUTOMOBILE		
<b>PRIORITY</b>			
<b>PRIORITY NUMBER</b>	<b>DATE</b>	<b>COUNTRY</b>	
2012-012401	25/05/2012	JAPAN	
<b>DESIGN NUMBER</b>	249694		
<b>CLASS</b>	09-01		
<b>1)PANCHWATI PRAYOGSHALA PVT. LTD., 19-A, MOHKAMPUR, PHASE-1, DELHI ROAD, MEERUT, U.P., INDIA. (AN INDIAN COMPANY DULY REGISTERED UNDER THE COMPANIES ACT, 1956)</b>			
<b>DATE OF REGISTRATION</b>	26/11/2012		
<b>TITLE</b>	BOTTLE		
<b>PRIORITY NA</b>			
<b>DESIGN NUMBER</b>	249014		
<b>CLASS</b>	30-99		
<b>1)NAVEEN KOHLI PROPRIETOR OF SHIVAM POLYMERS, AN INDIAN CITIZEN, OF B-16 SITE B, SURAJPUR INDUSTRIAL AREA, GREATER NOIDA-201306, UP, INDIA</b>			
<b>DATE OF REGISTRATION</b>	25/10/2012		
<b>TITLE</b>	TOY FOR PETS		
<b>PRIORITY NA</b>			

<b>DESIGN NUMBER</b>	245628	
<b>CLASS</b>	09-01	
<b>1)PRAMIT SANGHAVI AND DEWANG SANGHAVI, PARTNERS TRADING AS V2 CORP., A PARTNERSHIP FIRM, INDIAN, MANUFACTURERS AND MERCHANTS, WHOSE ADDRESS IS</b> WZ-8/1, INDUSTRIAL AREA, KIRTI NAGAR, NEW DELHI-110015, INDIA		
<b>DATE OF REGISTRATION</b>	29/05/2012	
<b>TITLE</b>	JAR	
<b>PRIORITY NA</b>		
<b>DESIGN NUMBER</b>	248006	
<b>CLASS</b>	07-01	
<b>1)MA DESIGN INDIA PRIVATE LIMITED, A COMPANY INCORPORATED IN INDIA HAVING ITS PRINCIPAL PLACE OF BUSINESS</b> AT A-41, SECTOR-80, PHASE-II, NOIDA-201305, U.P. INDIA		
<b>DATE OF REGISTRATION</b>	19/09/2012	
<b>TITLE</b>	CHEESEBOARD	
<b>PRIORITY NA</b>		
<b>DESIGN NUMBER</b>	248078	
<b>CLASS</b>	13-02	
<b>1)LUMINOUS POWER TECHNOLOGIES PVT. LTD.</b> PLOT-300, 2ND FLOOR, UDYOG VIHAR, PHASE-II, GURGAON, HARYANA-122016 (INDIA) AN INDIAN COMPANY		
<b>DATE OF REGISTRATION</b>	24/09/2012	
<b>TITLE</b>	INVERTER	
<b>PRIORITY NA</b>		

<b>DESIGN NUMBER</b>	249767	
<b>CLASS</b>	24-02	
<b>1)PIRAMAL ENTERPRISES LIMITED, A COMPANY INCORPORATED UNDER THE COMPANIES ACT, 1956 HAVING REGISTERED OFFICE AT PIRAMAL TOWERS, GANPATRAO KADAM MARG, LOWER PAREL, MUMBAI 400 013, MAHARASHTRA, INDIA, INDIAN NATIONAL</b>		
<b>DATE OF REGISTRATION</b>	29/11/2012	
<b>TITLE</b>	ELECTROLYTE ANALYZER	
<b>PRIORITY NA</b>		
<b>DESIGN NUMBER</b>	249846	
<b>CLASS</b>	15-04	
<b>1)DEERE &amp; COMPANY, A US CORPORATION OF ONE JOHN DEERE PLACE, MOLINE, ILLINOIS, 61265 - 8098, USA</b>		
<b>DATE OF REGISTRATION</b>	03/12/2012	
<b>TITLE</b>	EXCAVATOR	
<b>PRIORITY NA</b>		
<b>DESIGN NUMBER</b>	249868	
<b>CLASS</b>	08-06	
<b>1)(1) PARESHBHAI V. BHALIYA (2) CHANDRIKABEN P. BHALIYA (3) RAJESH O. KOTADIA (4) GHANSHYAM O. KOTADIA ALL INDIAN NATIONAL PARTNERS OF MARUTI METALS AN INDIAN PARTNERSHIP FIRM HAVING ITS PRINCIPAL PLACE OF BUSINESS AT SOMNATH ESTATE, SHOP NO. 3, NEAR DWARKADHISH ESTATE, VIRANI AGHAT, DHEBAR ROAD(SOUTH), RAJKOT-2, GUJARAT-INDIA</b>		
<b>DATE OF REGISTRATION</b>	03/12/2012	
<b>TITLE</b>	HANDLE	
<b>PRIORITY NA</b>		

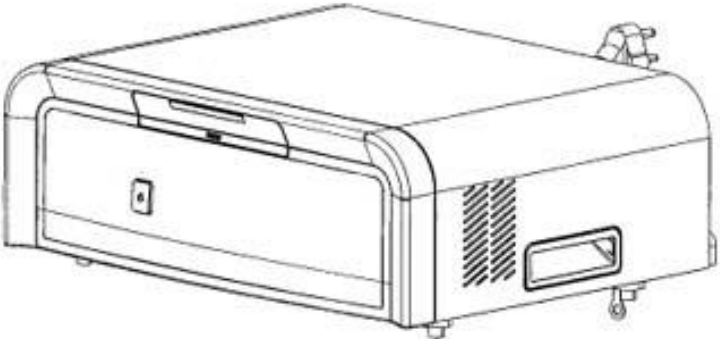
<b>DESIGN NUMBER</b>	248452	
<b>CLASS</b>	06-08	
<b>1)H. K. INDUSTRIES, OPP. RAILWAY STATION, MADEVI ROAD, MALERKOTLA-148023, DISTT. SANGRUR (PUNJAB) INDIA</b> AN INDIAN PROPRIETORSHIP FIRM WHOSE PROPRIETOR IS :-MOHD. HAFEEZ BEING INDIAN NATIONALS OF THE ABOVE ADDRESS		
<b>DATE OF REGISTRATION</b>	03/10/2012	
<b>TITLE</b>	CLOTH HANGER	
<b>PRIORITY NA</b>		

<b>DESIGN NUMBER</b>	248549	
<b>CLASS</b>	13-02	
<b>1)EXIDE INDUSTRIES LIMITED</b> 59E, CHOWRINGHEE ROAD, KOLKATA-700020, WEST BENGAL, INDIA AN INDIAN COMPANY		
<b>DATE OF REGISTRATION</b>	05/10/2012	
<b>TITLE</b>	INVERTER	
<b>PRIORITY NA</b>		

<b>DESIGN NUMBER</b>	248609	
<b>CLASS</b>	09-01	
<b>1)BERGER PAINTS INDIA LIMITED-BRITISH PAINTS DIVISION, A COMPANY INCORPORATED UNDER THE INDIAN COMPANIES ACT, 1956, NATIONALITY-INDIAN COMPANY, ADDRESS-</b> 19, DDA COMMERCIAL COMPLEX, KAILASH COLONY EXTENSION, ZAMRUDPUR, NEW DELHI-110 048		
<b>DATE OF REGISTRATION</b>	05/10/2012	
<b>TITLE</b>	BOTTLE	
<b>PRIORITY NA</b>		

<b>DESIGN NUMBER</b>	248159	
<b>CLASS</b>	26-03	
<b>1)CROMPTON GREAVES LIMITED, (AN INDIAN COMPANY), AVANTHA HOUSE, 6TH FLOOR, DR. ANNIE BESANT ROAD, WORLI, MUMBAI-400030, MAHARASHTRA, INDIA.</b>		
<b>DATE OF REGISTRATION</b>	26/09/2012	
<b>TITLE</b>	LIGHTING FIXTURE	
<b>PRIORITY NA</b>		

<b>DESIGN NUMBER</b>	248227	
<b>CLASS</b>	15-02	
<b>1)CROMPTON GREAVES LIMITED, (AN INDIAN COMPANY), AVANTHA HOUSE, 6TH FLOOR, DR. ANNIE BESANT ROAD, WORLI, MUMBAI-400030, MAHARASHTRA, INDIA.</b>		
<b>DATE OF REGISTRATION</b>	28/09/2012	
<b>TITLE</b>	CENTRIFUGAL PUMP	
<b>PRIORITY NA</b>		

<b>DESIGN NUMBER</b>	248238	
<b>CLASS</b>	15-03	
<b>1)PATEL RAKESHBHAI R. TRADING A NEW UMIYO AGRO INDUSTRIES, OF CHILODA MOTA, N.H. NO. 8, TALUKA &amp; DISTRICT - GANDHINAGAR – 382 355, GUJARAT, INDIA, AN INDIAN NATIONAL</b>		
<b>DATE OF REGISTRATION</b>	27/09/2012	
<b>TITLE</b>	GROUNNUT THRESHER	
<b>PRIORITY NA</b>		

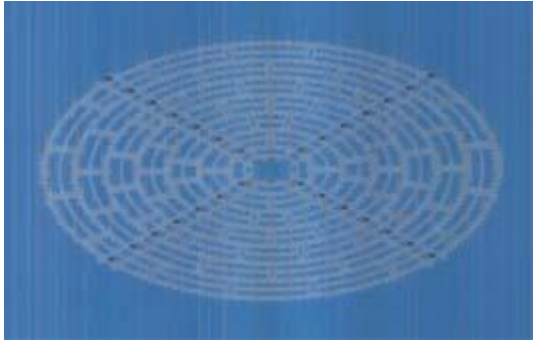
<b>DESIGN NUMBER</b>	248298	
<b>CLASS</b>	30-99	
<b>1)MR. MANINDER SINGH, 6, RAJA GARDEN, NEW DELHI-110015</b>		
<b>DATE OF REGISTRATION</b>	01/10/2012	
<b>TITLE</b>	MONKEY SCARER	
<b>PRIORITY NA</b>		

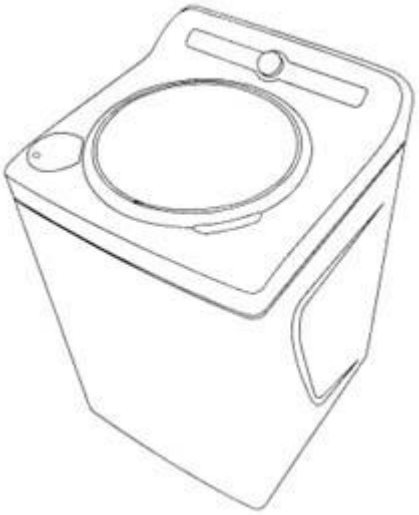
<b>DESIGN NUMBER</b>	248326	
<b>CLASS</b>	15-05	
<b>1)WHIRLPOOL OF INDIA LIMITED, AN INDIAN COMPANY HAVING ITS CORPORATE OFFICE AT WHIRLPOOL HOUSE, PLOT NO. 40, SECTOR-44, GURGAON-122 002, HARYANA, INDIA</b>		
<b>DATE OF REGISTRATION</b>	03/10/2012	
<b>TITLE</b>	WASHING MACHINE	
<b>PRIORITY NA</b>		

<b>DESIGN NUMBER</b>	248336	
<b>CLASS</b>	02-02	
<b>1)X &amp; O CLOTHING PVT. LTD., (AN INDIAN PRIVATE LIMITED COMPANY REGISTERED UNDER THE INDIAN COMPANIES ACT, 1956), OF 3, THAKUR COMPOUND, 1ST FLOOR, NEXT TO ABB, USV LTD., LANE, OFF. B.S. DEVSHI MARG, GOVANDI(EAST), MUMBAI-400088. MAHARASHTRA, INDIA.</b>		
<b>DATE OF REGISTRATION</b>	03/10/2012	
<b>TITLE</b>	GARMENT (SET)	
<b>PRIORITY NA</b>		