

**INTRODUCTION**

In view of the recent amendment made in the Designs (Amendment) Rules, 2008 with effect from 17/06/2008, Publication of the matter relating to Designs is being published in the Official Journal of The Patent Office. This Journal is being published on weekly basis on every Friday covering the various proceedings on Designs as required according to the provisions of under Rule 22, 25, 27 and 39 of the Design (Amendment) Rules, 2008. All the enquiries on this Official Journal and other information as required by the public should be addressed to the Controller General of Patents, Designs & Trade Marks. Suggestions and comments are requested from all quarters so that the content can be enriched.

**DESIGN**  
**CORRIGENDUM**

The Registered Design No. 248266 which has been erroneously published in the official Journal of India dated 02/08/2013, part –II, at page 20316, column 2 as Registered Design No. “s” in the name of JOSEPH VÖGELE AG, OF JOSEPH-VÖGELE-STR.1, 67067 LUDWIGSHAFEN/RHEIN, GERMANY; NATIONALITY: GERMAN Class 15-04, Date of Registration 28/09/2012, Titled as SCREED OF A ROAD MAKING MACHINE, Priority Number 001322689 Date 29/03/2012, Country OHIM should read as Registered Design No. 248266 in the name of JOSEPH VÖGELE AG, OF JOSEPH-VÖGELE-STR.1, 67067 LUDWIGSHAFEN/RHEIN, GERMANY; NATIONALITY: GERMAN Class 15-04, Date of Registration 28/09/2012, Titled as SCREED OF A ROAD MAKING MACHINE, Priority Number 001322689 Date 29/03/2012, Country OHIM.

## **COPYRIGHT PUBLICATION**

<b>SL NO</b>	<b>CASE NUMBERS</b>	<b>RENEWED ON</b>
<b>1.</b>	<b>193436</b>	<b>24.07.2013</b>
<b>2.</b>	<b>193437</b>	<b>24.07.2013</b>
<b>3.</b>	<b>193438</b>	<b>23.07.2013</b>
<b>4.</b>	<b>193580</b>	<b>23.07.2013</b>
<b>5.</b>	<b>193581</b>	<b>22.07.2013</b>
<b>6.</b>	<b>229305</b>	<b>23.07.2013</b>
<b>7.</b>	<b>239804</b>	<b>22.07.2013</b>
<b>8.</b>	<b>179014</b>	<b>16.07.2013</b>
<b>9.</b>	<b>186217</b>	<b>17.07.2013</b>
<b>10.</b>	<b>186218</b>	<b>17.07.2013</b>

**DESIGN ACT 2000**  
**(Under Section 31)**  
**RECTIFICATION OF REGISTER**

PULK PTE. LTD, a company of Singapore has filed an application on Form-17 through their agent S. Jayaram of Lakshmikumaran & Sridharan, New Delhi on 09/07/2013 for the rectification of name of the Assignor and Assignee in the Register of Designs are as follows:-

<b>Design No.</b>	<b>Entered name of the Assignor and Assignee</b>	<b>Changed to</b>
244773	PULKE PTE. LTD (Assignee) RIGHT CO. LTD (Assignor)	PULK PTE LTD (Assignee) RIGHTS CO. LTD (Assignor)

Notice of opposition to the Rectification of Register of Designs may be given as per rule 40 of the Design Rules, 2001 as amended Design (amendment) Rules, 2008.

**THE DESIGNS ACT 2000  
SECTION 30  
DESIGN ASSIGNMENT**

The Design stands in the name of **SOCIETE DE TECHNOLOGIE MICHELIN (CO-PROPRIETOR)** registered under the Designs Act, 2000 has been assigned in the Register of Designs in the name as follows:-

<b>Design Nos.</b>	<b>Class</b>	<b>Name</b>
<b>240810</b>	<b>12-15</b>	<b>COMPAGNIE GENERALE DES ETABLISSEMENTS MICHELIN, A FRENCH COMPANY OF 12 COURS SABLON-F-63000, CLERMONT-FERRAND, FRANCE</b>



**THE DESIGNS ACT 2000  
SECTION 30  
DESIGN ASSIGNMENT**

The Design stands in the name of **MUHAMMED ASLAM NASIR**, registered under the Designs Act, 2000 has initially licensed his right to use and exploit the design to **TALRIA LIMITED** has further licensed his right to use and exploit the design in the Register of Designs in the name as follows:-

<b>Design No.</b>	<b>Class</b>	<b>Name</b>
<b>197584</b>	<b>24-01</b>	<b>INTERSURGICAL UAB, A COMPANY REGISTERED IN LITHUANIA UNDER NUMBER 1150243, OF ARNIONIU 60/28-1, LT 4710 PABRADE, LITHUANIA</b>

## REGISTRATION OF DESIGNS

The following designs have been registered. They are now open for public inspection. In the following each entry the Date of Registration is shown. The Priority Number, Priority Date and Priority Country are also shown

<b>DESIGN NUMBER</b>	246871	
<b>CLASS</b>	09-01	
<b>1)INTERNATIONAL FOODSTUFFS COMPANY (LIMITED LIABILITY COMPANY, UNDER THE LAWS OF UNITED ARAB EMIRATES) HAVING ADDRESS</b> AT POST BOX NO. 4115, SHARJAH, UNITED ARAB EMIRATES		
<b>DATE OF REGISTRATION</b>	01/08/2012	
<b>TITLE</b>	CARBOY	
<b>PRIORITY NA</b>		
<b>DESIGN NUMBER</b>	251710	
<b>CLASS</b>	06-01	
<b>1)THE SUPREME INDUSTRIES LTD., (AN INDIAN PUBLIC LIMITED COMPANY),</b> 601 CENTRAL PLAZA, 2/6, SARAT BOSE ROAD, KOLKATA - 700020, WEST BENGAL, INDIA		
<b>DATE OF REGISTRATION</b>	18/02/2013	
<b>TITLE</b>	CHAIR	
<b>PRIORITY NA</b>		
<b>DESIGN NUMBER</b>	251744	
<b>CLASS</b>	08-06	
<b>1)MANISHBHAI GORDHANBHAI RAKHOLIYA (INDIAN NATIONAL) SOLE PROPRIETOR OF DHRUVILA METALS (PROPRIETORSHIP CONCERN) HAVING PLACE OF BUSINESS AT-</b> KOTHARIYA MAIN ROAD, SIYANI CHAMBERS NR. KHODIYAR GRINDING, RAJKOT-360002-GUJARAT (INDIA)		
<b>DATE OF REGISTRATION</b>	19/02/2013	
<b>TITLE</b>	HANDLE	
<b>PRIORITY NA</b>		

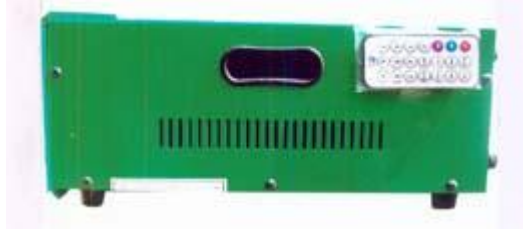
<b>DESIGN NUMBER</b>	244611	
<b>CLASS</b>	26-05	
<b>1)M/S. MADNANI ENGINEERING WORKS, 10/B, CO-OPERATIVE INDUSTRIAL ESTATE, UDYOG NAGAR, KANPUR-208022, UTTAR PRADESH, INDIA,</b>		
<b>DATE OF REGISTRATION</b>	13/04/2012	
<b>TITLE</b>	DEVICE FOR SOLAR LIGHT	
<b>PRIORITY NA</b>		

<b>DESIGN NUMBER</b>	247066
<b>CLASS</b>	19-04
<b>1)AKRAM SHAIKH, AN INDIAN NATIONAL, TRADING M/S. SMART NOTEBOOKS, A PROPRIETARY CONCERN, HAVING OFFICE AT 1542-2, KHAMLAHAD STREET, NEAR PRAJAPATI ASHRAM, CHARPUL ROAD, NAVSARI-396445, GUJARAT, INDIA</b>	
<b>DATE OF REGISTRATION</b>	09/08/2012
<b>TITLE</b>	STATIONERY ARTICLE
<b>PRIORITY NA</b>	



<b>DESIGN NUMBER</b>	249045
<b>CLASS</b>	28-03
<b>1)(1)MANOJKUMAR CHANDULAL RANPARA OF (2)TUSHARBHAI MANOJKUMAR RANPARA (3)DEVANGBHAI MANOJKUMAR RANPARA (ALL PARTNERS ARE ADULT AND INDIAN NATIONAL) PARTNER OF NEW RANPARA INDUSTRIES (INDIAN PARTNERSHIP FIRM) HAVING PLACE OF BUSINESS AT -PANCHASAR ROAD, B/H. GEETA OIL MILL, MORBI-363641 DIST:RAJKOT- GUJARAT (INDIA)</b>	
<b>DATE OF REGISTRATION</b>	29/10/2012
<b>TITLE</b>	TONGUE CLEANER
<b>PRIORITY NA</b>	



<b>DESIGN NUMBER</b>	251053	
<b>CLASS</b>	12-11	
<b>1)HERO CYCLES LIMITED, HERO NAGAR, G. T. ROAD, LUDHIANA-141003 (PUNJAB), INDIA, (AN INDIAN COMPANY DULY INCORPORATED UNDER THE PROVISIONS OF INDIAN COMPANIES ACT, 1956)</b>		
<b>DATE OF REGISTRATION</b>	21/01/2013	
<b>TITLE</b>	BICYCLE	
<b>PRIORITY NA</b>		

<b>DESIGN NUMBER</b>	251159	
<b>CLASS</b>	31-00	
<b>1)KONINKLIJKE PHILIPS ELECTRONICS N.V., A COMPANY ORGANIZED AND EXISTING UNDER THE LAWS OF THE KINGDOM OF THE NETHERLANDS, RESIDING AT EINDHOVEN, WHOSE POST-OFFICE ADDRESS IS GROENEWOUDSEWEG 1, 5621 BA, EINDHOVEN, THE NETHERLANDS</b>		
<b>DATE OF REGISTRATION</b>	23/01/2013	
<b>TITLE</b>	SALAD MAKER	
<b>PRIORITY</b>		
<b>PRIORITY NUMBER</b>	<b>DATE</b>	<b>COUNTRY</b>
002079970-0001	26/07/2012	OHIM

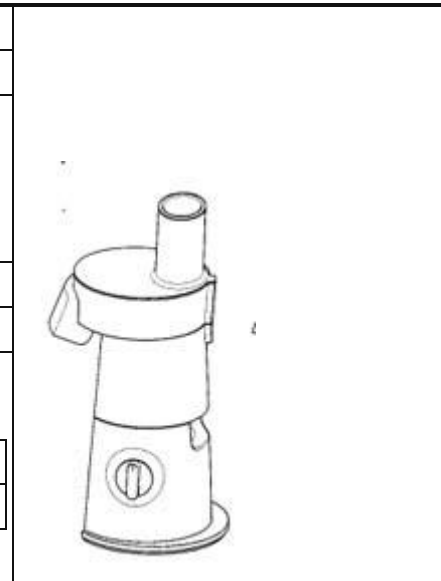

<b>DESIGN NUMBER</b>	251175	
<b>CLASS</b>	08-06	
<b>1)JAYESHBHAI DINESHBHAI SOJITRA (ADULT, &amp; INDIAN NATIONAL) PROPRIETOR OF BALAJI INDUSTRIES (INDIAN PROPRIETORSHIP CONCERN) HAVING PLACE OF BUSINESS AT : VIRANI AGHAT, OPP: MANGAL PAN STREET, BALAJI ESTATE, OPP: PAWAN INDUSTRIES RAJKOT-GUJARAT (INDIA)</b>		
<b>DATE OF REGISTRATION</b>	24/01/2013	
<b>TITLE</b>	HANDLE	
<b>PRIORITY NA</b>		





<b>DESIGN NUMBER</b>	246257	
<b>CLASS</b>	13-01	
<b>1)KABUSHIKI KAISHA YASKAWA DENKI A JAPANESE COMPANY OF THE ADDRESS:</b> 2-1, KUROSAKI-SHIROISHI, YAHATANISHI-KU, KITAKYUSHU-SHI, FUKUOKA 806-0004, JAPAN		
<b>DATE OF REGISTRATION</b>	27/06/2012	
<b>TITLE</b>	ROTARY ELECTRIC MACHINE	
<b>PRIORITY NA</b>		
<b>DESIGN NUMBER</b>	248906	
<b>CLASS</b>	09-01	
<b>1)BASF SE, A GERMAN COMPANY OF</b> 67056, LUDWIGSHAFEN, GERMANY		
<b>DATE OF REGISTRATION</b>	19/10/2012	
<b>TITLE</b>	BOTTLE	
<b>PRIORITY NA</b>		
<b>DESIGN NUMBER</b>	248961	
<b>CLASS</b>	09-03	
<b>1)ORION CORPORATION, A KOREAN CORPORATION, OF</b> 30-10, MUNBAE-DONG, YONGSAN-GU, SEOUL, REPUBLIC OF KOREA		
<b>DATE OF REGISTRATION</b>	23/10/2012	
<b>TITLE</b>	CONFECTIONERY BOX	
<b>PRIORITY NA</b>		

<b>DESIGN NUMBER</b>	245803	
<b>CLASS</b>	23-01	
<b>1)JOHN GUEST INTERNATION LIMITED OF</b> HORTON ROAD, WEST DRAYTON, MIDDLESSEX UB7 8JL, UNITED KINGDOM		
<b>DATE OF REGISTRATION</b>	08/06/2012	
<b>TITLE</b>	CONNECTOR FOR CABLES AND DUCTS	
<b>PRIORITY</b>		
<b>PRIORITY NUMBER</b>	<b>DATE</b>	<b>COUNTRY</b>
001306039-0001	09/12/2011	OHIM

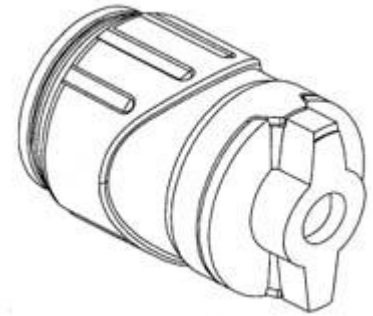

<b>DESIGN NUMBER</b>	248605	
<b>CLASS</b>	24-02	
<b>1)BECTON, DICKINSON AND COMPANY, A CORPORATION ORGANISED</b> <b>UNDER THE LAWS OF THE UNITED STATES OF AMERICA,</b> OF 1 BECTON DRIVE, MC 110, FRANKLIN LAKES, NJ 07417-1880, THE UNITED STATES OF AMERICA		
<b>DATE OF REGISTRATION</b>	12/10/2012	
<b>TITLE</b>	VESSEL ASSEMBLY	
<b>PRIORITY</b>		
<b>PRIORITY NUMBER</b>	<b>DATE</b>	<b>COUNTRY</b>
29/418, 181	12/04/2012	U.S.A.



<b>DESIGN NUMBER</b>	250819	
<b>CLASS</b>	13-03	
<b>1)LARSEN &amp; TOUBRO LIMITED, AN INDIAN COMPANY INCORPORATED</b> <b>UNDER THE COMPANIES ACT, 1956 OF</b> L & T HOUSE, BALLARD ESTATE, MUMBAI 400001, STATE OF MAHARASHTRA, INDIA		
<b>DATE OF REGISTRATION</b>	07/01/2013	
<b>TITLE</b>	MOULDED CASE CIRCUIT BREAKER	
<b>PRIORITY NA</b>		



<b>DESIGN NUMBER</b>	250882	
<b>CLASS</b>	12-16	
<b>1)FORD GLOBAL TECHNOLOGIES, LLC A COMPANY ORGANIZED AND EXISTING UNDER THE LAWS OF UNITED STATES OF AMERICA, HAVING ITS OFFICE AT</b> SUITE 800, 330 TOWN CENTER DRIVE, DEARBORN MICHIGAN-48126, UNITED STATES OF AMERICA		
<b>DATE OF REGISTRATION</b>	09/01/2013	
<b>TITLE</b>	VEHICLE WHEEL RIM	
<b>PRIORITY</b>		
<b>PRIORITY NUMBER</b>	<b>DATE</b>	<b>COUNTRY</b>
402012100596.0	02/08/2012	GERMANY



<b>DESIGN NUMBER</b>	250391	
<b>CLASS</b>	23-02	
<b>1)HANS GROHE SE, OF</b> AUESTR. 5-9, D-77761 SCHILTACH, GERMANY, A GERMAN COMPANY		
<b>DATE OF REGISTRATION</b>	20/12/2012	
<b>TITLE</b>	HOLDER FOR HAND SHOWER	
<b>PRIORITY</b>		
<b>PRIORITY NUMBER</b>	<b>DATE</b>	<b>COUNTRY</b>
001334486-0008	11/07/2012	OHIM



<b>DESIGN NUMBER</b>	232670	
<b>CLASS</b>	02-02	
<b>1)MAHOTSAV CREATION PVT. LTD.,</b> "MAHOTSAV HOUSE" NO.6, RATHI PALACE, RING ROAD, SURAT-385002, GUJARAT		
<b>DATE OF REGISTRATION</b>	16/11/2010	
<b>TITLE</b>	SAREE AND BLOUSE SET	
<b>PRIORITY NA</b>		



<b>DESIGN NUMBER</b>	249781		
<b>CLASS</b>	14-02		
<b>1)KLIO-ETERNA SCHREIBGER TE GMBH &amp; CO KG, OF GLASHÜTTENWEG 7, 77709 WOLFACH, GERMANY</b>			
<b>DATE OF REGISTRATION</b>	30/11/2012		
<b>TITLE</b>	USB-STICK		
<b>PRIORITY</b>			
<b>PRIORITY NUMBER</b>	<b>DATE</b>	<b>COUNTRY</b>	
673464001	06/06/2012	WIPO	
<b>DESIGN NUMBER</b>	251288		
<b>CLASS</b>	12-10		
<b>1)(1) NIKHILBHAI P. AMBANI (2) MAHENDRABHAI M. AMBANI (3) MAHADEVBHAI T. AMBANI ALL INDIAN NATIONAL PARTNERS OF TIRUPATI AGRO INDUSTRIES AN INDIAN PARTNERSHIP FIRM HAVING ITS PRINCIPAL PLACE OF BUSINESS AT ADDRESS:- NEAR REWA PARK, MORBI-RAJKOT HIGHWAY, VIRPAR (MORBI)-363 641, DIST.: RAJKOT, GUJARAT-INDIA</b>			
<b>DATE OF REGISTRATION</b>	29/01/2013		
<b>TITLE</b>	TRACTOR TRAILER		
<b>PRIORITY NA</b>			
<b>DESIGN NUMBER</b>	251296		
<b>CLASS</b>	08-09		
<b>1)RAKESHBHAI VITTHALBHAI BHALARA AN INDIAN NATIONAL SOLE PROPRIETOR OF DIVINE OVERSEAS INDIA AN INDIAN PROPRIETORSHIP FIRM HAVING ITS PRINCIPAL PLACE OF BUSINESS AT PLOT NO. 4, SURVEY NO. 229, OPP. SARDAR CASTING, B/H. PARIN FURNITURE, DHOLRA ROAD, GONDAL HIGHWAY, RAJKOT, GUJARAT-INDIA</b>			
<b>DATE OF REGISTRATION</b>	29/01/2013		
<b>TITLE</b>	GLASS PATCH FITTINGS		
<b>PRIORITY NA</b>			

<b>DESIGN NUMBER</b>	244251	
<b>CLASS</b>	24-02	
<b>1)BECTON, DICKINSON AND COMPANY</b> 1 BECTON DRIVE, FRANKLIN LAKES, NEW JERSEY 07417-1880, USA		
<b>DATE OF REGISTRATION</b>	30/03/2012	
<b>TITLE</b>	REAGENT HOLDER SET	
<b>PRIORITY</b>		
<b>PRIORITY NUMBER</b>	<b>DATE</b>	<b>COUNTRY</b>
29/403, 131	30/09/2011	U.S.A.

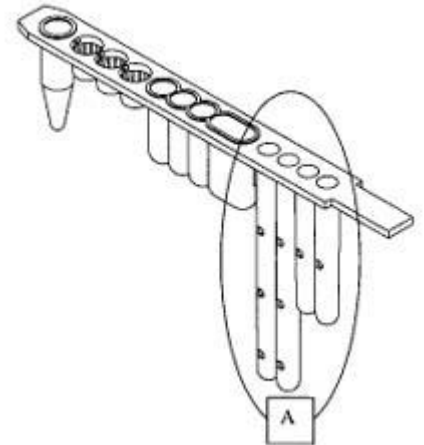

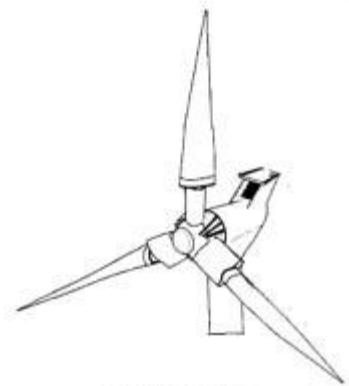

<b>DESIGN NUMBER</b>	249423	
<b>CLASS</b>	13-01	
<b>1)YOUWINENERGY GMBH, A COMPANY ORGANIZED AND EXISTING UNDER THE LAWS OF GERMANY, HAVING ITS OFFICE AT RUDOLF-DIESEL-STR. 9, D-26135 OLDENBURG, ALEMANIA, GERMANY</b>		
<b>DATE OF REGISTRATION</b>	09/11/2012	
<b>TITLE</b>	NACELLE OF WIND TURBINE	
<b>PRIORITY</b>		
<b>PRIORITY NUMBER</b>	<b>DATE</b>	<b>COUNTRY</b>
002103267	14/09/2012	OHIM



<b>DESIGN NUMBER</b>	249579	
<b>CLASS</b>	11-01	
<b>1)DEREWALA JEWELLERY INDUSTRIES LTD. (NATIONALITY-INDIAN)</b> AT-E-73, EPIP, SITAPURA INDUSTRIAL AREA, TONK ROAD, JAIPUR (RAJ.) NATIONALITY-INDIAN		
<b>DATE OF REGISTRATION</b>	20/11/2012	
<b>TITLE</b>	PENDANT	
<b>PRIORITY NA</b>		

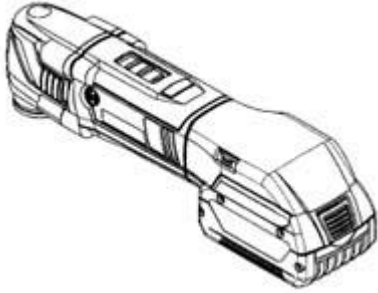

<b>DESIGN NUMBER</b>	251747		
<b>CLASS</b>	08-06		
<b>1)MUKESHBHAI GORDHANBHAI RAKHOLIYA (ADULT AND INDIAN NATIONAL) AND SOLE PROPRIETOR OF RAMESHWAR METAL (INDIAN PROPRIETORSHIP CONCERN) HAVING PLACE OF BUSINESS AT- 4, PARSANA SOCIETY, 50 FEET MAIN ROAD, B/H. 73 NUMBERS SCHOOL, RAJKOT-GUJARAT-(INDIA)</b>			
<b>DATE OF REGISTRATION</b>	19/02/2013		
<b>TITLE</b>	HANDLE		
<b>PRIORITY NA</b>			
<b>DESIGN NUMBER</b>	251757		
<b>CLASS</b>	13-02		
<b>1)ROBERT BOSCH GMBH, A GERMAN COMPANY OF POSTFACH 30 02 20, 70442 STUTTGART, DE, GERMANY</b>			
<b>DATE OF REGISTRATION</b>	19/02/2013		
<b>TITLE</b>	OSCILLATOR		
<b>PRIORITY</b>			
<b>PRIORITY NUMBER</b>	<b>DATE</b>	<b>COUNTRY</b>	
002117820	12/10/2012	OHIM	
<b>DESIGN NUMBER</b>	251782		
<b>CLASS</b>	21-01		
<b>1)PLAYGRO TOYS INDIA PVT. LTD., 2057/38, GURUDWARA ROAD, KAROL BAGH, NEW DELHI-110005, INDIA. (AN INDIAN COMPANY DULY REGISTERED UNDER THE COMPANIES ACT, 1956)</b>			
<b>DATE OF REGISTRATION</b>	19/02/2013		
<b>TITLE</b>	TOY BLOCK		
<b>PRIORITY NA</b>			

<b>DESIGN NUMBER</b>	249078	
<b>CLASS</b>	08-09	
<b>1)MR. DILIP VITHALDAS NIRMAL INDIAN NATIONALS TRADING IN THE NAME AND STYLE OF MODERN INNOVATIONS. (A PROPRIETORSHIP CONCERN) WHOSE ADDRESS IS</b> MODERN INNOVATIONS. 4, PARASNATH DARSHAN, KHALAI VILLAGE, KIROL KURLA ROAD, VIDYAVIHAR (WEST) 400086., MAHARASHTRA, INDIA		
<b>DATE OF REGISTRATION</b>	29/10/2012	
<b>TITLE</b>	GLASS FITTING	
<b>PRIORITY NA</b>		

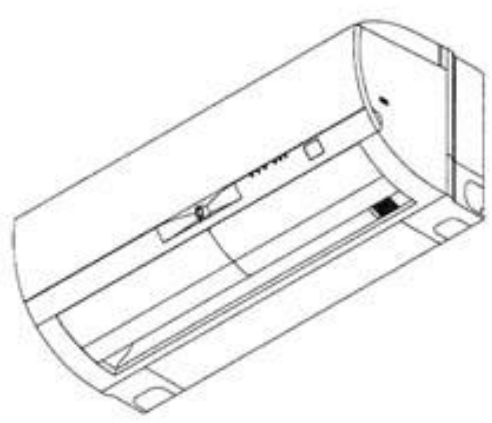
<b>DESIGN NUMBER</b>	251199	
<b>CLASS</b>	23-04	
<b>1)MITSUBISHI ELECTRIC CORPORATION, A JAPANESE COMPANY ORGANIZED AND EXISTING UNDER THE LAWS OF JAPAN, MANUFACTURERS AND MERCHANTS, OF THE ADDRESS</b> 7-3, MARUNOUCHI 2-CHOME, CHIYODA-KU, TOKYO 100-8310, JAPAN		
<b>DATE OF REGISTRATION</b>	24/01/2013	
<b>TITLE</b>	AIR CONDITIONER	
<b>PRIORITY</b>		
<b>PRIORITY NUMBER</b>	<b>DATE</b>	<b>COUNTRY</b>
2012-018064	30/07/2012	JAPAN

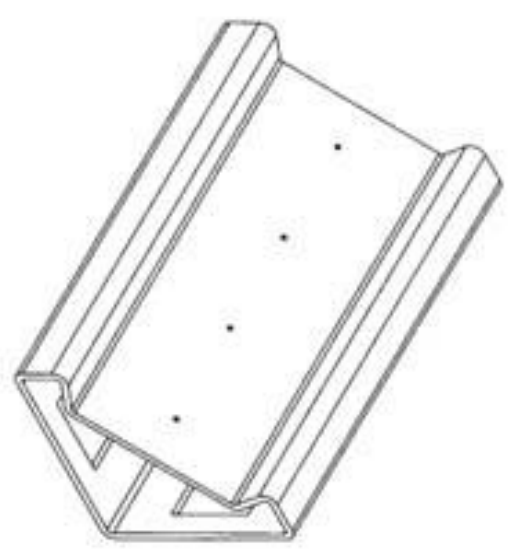
<b>DESIGN NUMBER</b>	240942	
<b>CLASS</b>	06-06	
<b>1)INGETEA POWER TECHNOLOGY, S.A.,</b> SPAIN, PARQUE TECNOLÓGICO DE BIZKAIA EDIFICIO 106 2 <sup>o</sup> PLANTA 48170 ZAMUDIO BIZKAIA (SPAIN)		
<b>DATE OF REGISTRATION</b>	24/11/2011	
<b>TITLE</b>	COMPONENTS FOR CUPBOARDS	
<b>PRIORITY</b>		
<b>PRIORITY NUMBER</b>	<b>DATE</b>	<b>COUNTRY</b>
001868480-0003	25/05/2011	OHIM



<b>DESIGN NUMBER</b>	248134	
<b>CLASS</b>	08-07	
<b>1)MAHESHBHAI M. VADGAMA AN INDIAN NATIONAL SOLE PROPRIETOR OF AMAR HARDWARE PRODUCTS AN INDIAN PROPRIETORSHIP FIRM HAVING ITS PRINCIPAL PLACE OF BUSINESS</b> AT SAMRAT INDUSTRIAL AREA, 50 FEET MAIN ROAD, NEAR TECHNO HYDRAULIC, B/H. S.T. WORKSHOP, RAJKOT, GUJARAT-INDIA.		
<b>DATE OF REGISTRATION</b>	25/09/2012	
<b>TITLE</b>	TOWER BOLT	
<b>PRIORITY NA</b>		

<b>DESIGN NUMBER</b>	246370	
<b>CLASS</b>	10-04	
<b>1)METTLER-TOLEDO AG, A SWISS COMPANY,</b> IM LANGACHER 44 CH-8606 GREIFENSEE, SWITZERLAND		
<b>DATE OF REGISTRATION</b>	05/07/2012	
<b>TITLE</b>	DIMENSION MEASURING INSTRUMENT	
<b>PRIORITY</b>		
<b>PRIORITY NUMBER</b>	<b>DATE</b>	<b>COUNTRY</b>
001986472	03/02/2012	OHIM



<b>DESIGN NUMBER</b>	250877	
<b>CLASS</b>	26-06	
<b>1)FORD GLOBAL TECHNOLOGIES, LLC A COMPANY ORGANIZED AND EXISTING UNDER THE LAWS OF UNITED STATES OF AMERICA, HAVING ITS OFFICE AT</b> SUITE 800, 330 TOWN CENTER DRIVE, DEARBORN MICHIGAN-48126, UNITED STATES OF AMERICA		
<b>DATE OF REGISTRATION</b>	09/01/2013	
<b>TITLE</b>	VEHICLE TAILLIGHT	
<b>PRIORITY</b>		
<b>PRIORITY NUMBER</b>	<b>DATE</b>	<b>COUNTRY</b>
402012100597.9	02/08/2012	GERMANY





<b>DESIGN NUMBER</b>	250592	
<b>CLASS</b>	09-03	
<b>1)SOREMARTEC S.A., A BELGIAN JOINT STOCK COMPANY OF RUE JOSEPH NETZER 5, B-6700 ARLON, BELGIUM</b>		
<b>DATE OF REGISTRATION</b>	02/01/2013	
<b>TITLE</b>	BOX	
<b>PRIORITY</b>		
<b>PRIORITY NUMBER</b>	<b>DATE</b>	<b>COUNTRY</b>
DM/078834	06/07/2012	WIPO

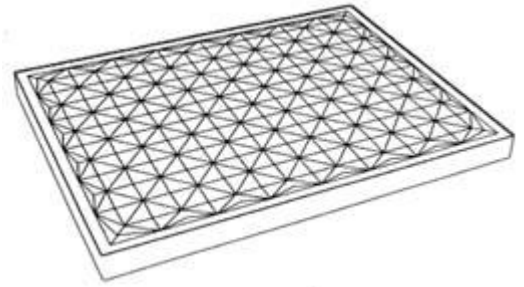

<b>DESIGN NUMBER</b>	249667	
<b>CLASS</b>	09-01	
<b>1)PEARL POLYMERS LIMITED, 204, ROHIT HOUSE, 3, TOLSTOY MARG, NEW DELHI-110 001, INDIA, A COMPANY INCORPORATED UNDER THE COMPANIES ACT, 1956, OF THE ABOVE ADDRESS</b>		
<b>DATE OF REGISTRATION</b>	23/11/2012	
<b>TITLE</b>	BOTTLE	
<b>PRIORITY NA</b>		



<b>DESIGN NUMBER</b>	249691	
<b>CLASS</b>	09-08	
<b>1)RIYO PARAPACK PVT. LTD., 411, RAHEJA CHAMBERS, NARIMAN POINT, MUMBAI-400 021. STATE OF MAHARASHTRA, (INDIA), A PVT. LTD., COMPANY INCORPORATED UNDER INDIAN COMPANIES ACT, INDIAN NATIONAL OF ABOVE ADDRESS</b>		
<b>DATE OF REGISTRATION</b>	26/11/2012	
<b>TITLE</b>	PALLET	
<b>PRIORITY NA</b>		



<b>DESIGN NUMBER</b>	251233	
<b>CLASS</b>	13-03	
<b>1)ABB TECHNOLOGY AG, A SWISS COMPANY OF AFFOLTERNSTRASSE 44, 8050 ZÜRICH, SWITZERLAND</b>		
<b>DATE OF REGISTRATION</b>	28/01/2013	
<b>TITLE</b>	SWITCHING DEVICE FOR AN ELECTRICAL SWITCHGEAR	
<b>PRIORITY</b>		
<b>PRIORITY NUMBER</b>	<b>DATE</b>	<b>COUNTRY</b>
002081570	31/07/2012	OHIM

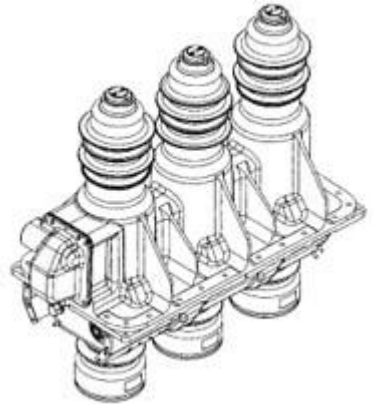

<b>DESIGN NUMBER</b>	249096	
<b>CLASS</b>	08-05	
<b>1)METALLIZING EQUIPMENT COMPANY PVT. LTD. E-101, M.I.A, PHASE-2, BASNI, JODHPUR-342005, RAJASTHAN, INDIA</b>		
<b>DATE OF REGISTRATION</b>	30/10/2012	
<b>TITLE</b>	OXY LIQUID FUEL GAS GUN	
<b>PRIORITY NA</b>		



<b>DESIGN NUMBER</b>	251081	
<b>CLASS</b>	06-02	
<b>1)MUKA METAL TICARET VE SANAYI ANONIM SIRKETI, A COMPANY INCORPORATED IN TURKEY AND HAVING ITS ADDRESS AT ORGANIZE SANAYI BOLGESI 9.CAD.NO:16 MELIKGAZI KAYSERI, TURKIYE</b>		
<b>DATE OF REGISTRATION</b>	21/01/2013	
<b>TITLE</b>	HOSPITAL BED	
<b>PRIORITY NA</b>		



<b>DESIGN NUMBER</b>	244257	
<b>CLASS</b>	24-02	
<b>1)BECTON, DICKINSON AND COMPANY</b> 1 BECTON DRIVE, FRANKLIN LAKES, NEW JERSEY 07417-1880, USA		
<b>DATE OF REGISTRATION</b>	30/03/2012	
<b>TITLE</b>	REAGENT HOLDER SET	
<b>PRIORITY</b>		
<b>PRIORITY NUMBER</b>	<b>DATE</b>	<b>COUNTRY</b>
29/403, 131	30/09/2011	U.S.A.

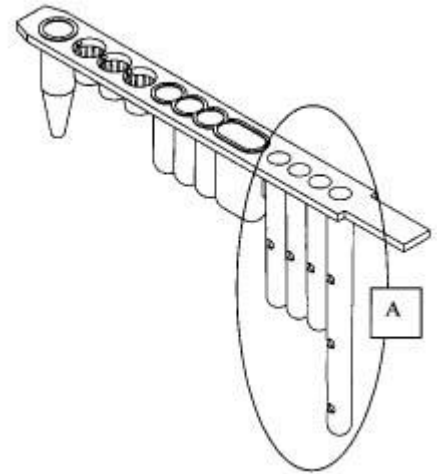

<b>DESIGN NUMBER</b>	249331	
<b>CLASS</b>	23-02	
<b>1)VOLA A/S, A JOINT STOCK COMPANY ESTABLISHED UNDER THE DANISH LAW, OF</b> LUNAVEJ 2, 8700 HORSENS, DENMARK		
<b>DATE OF REGISTRATION</b>	08/11/2012	
<b>TITLE</b>	SHOWER HEAD	
<b>PRIORITY</b>		
<b>PRIORITY NUMBER</b>	<b>DATE</b>	<b>COUNTRY</b>
002039693-0001	10/05/2012	OHIM

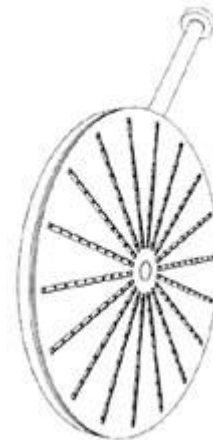

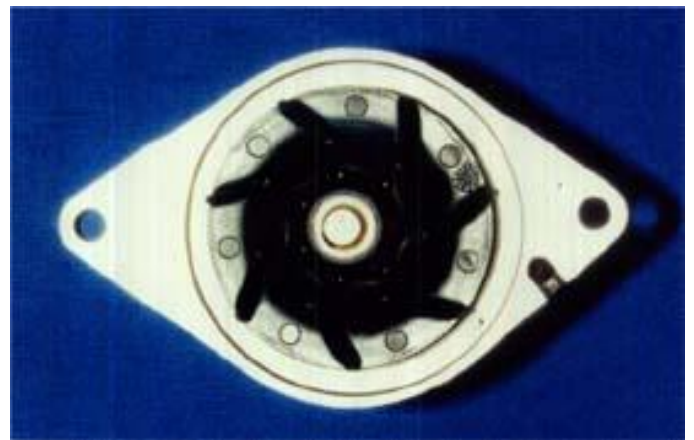

<b>DESIGN NUMBER</b>	249434
<b>CLASS</b>	12-16
<b>1)CONCENTRIC PUMPS PUNE PVT. LTD. A COMPANY REGISTERED UNDER COMPANY ACT 1956 OF</b> GAT NO. 26/1, 27 & 28 (PART), OFF PUNE-NAGAR ROAD, VILLAGE LONIKAND, P.O. LONIKAND, TALUKA HAVELI, PUNE-412216, MAHARASHTRA, INDIA	
<b>DATE OF REGISTRATION</b>	12/11/2012
<b>TITLE</b>	ENGINE COOLING WATER PUMP
<b>PRIORITY NA</b>	

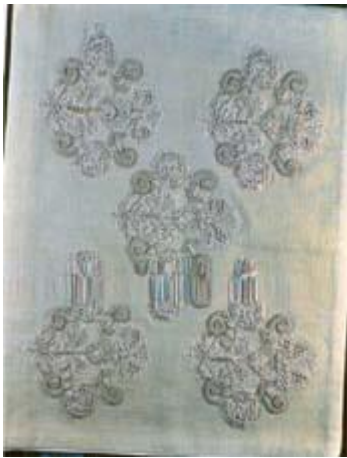

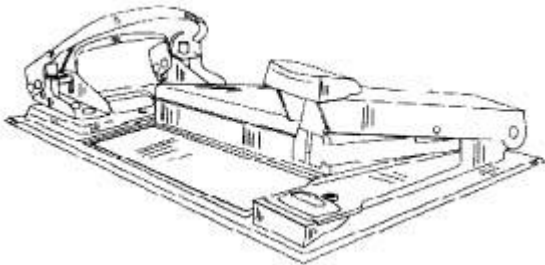

<b>DESIGN NUMBER</b>	249593	
<b>CLASS</b>	06-13	
<b>1)SARITA HANDA DESIGN WORKS PVT. LTD., AN INDIAN COMPANY OF D-11, DEFENCE COLONY, NEW DELHI-110024, INDIA</b>		
<b>DATE OF REGISTRATION</b>	20/11/2012	
<b>TITLE</b>	PILLOW COVER	
<b>PRIORITY NA</b>		



<b>DESIGN NUMBER</b>	251791	
<b>CLASS</b>	19-02	
<b>1)TEJAS SAMBHAJI HAGAVANE, AN INDIAN NATIONAL, HAVING ADDRESS: SAI SATYAM PARK, NEAR GANESH TEMPLE, WAGHOLI, PUNE-412007.</b>		
<b>DATE OF REGISTRATION</b>	20/02/2013	
<b>TITLE</b>	MULTI-UTILITY STATIONARY DEVICE	
<b>PRIORITY NA</b>		

<b>DESIGN NUMBER</b>	251893	
<b>CLASS</b>	24-01	
<b>1)MR. MADHUKAR G. GOKHALE AN INDIAN NATIONAL TRADING IN THE NAME AND STYLE OF MANMAN MFG. CO. PVT. LTD (A CORPORATE ENTITY INCORPORATED IN INDIA UNDER THE COMPANIES ACT, 1956) WHOSE ADDRESS IS 1157, SADASHIV PETH, OPP. BOY'S BHAVE HIGH SCHOOL, PUNE-411030, MAHARASHTRA, INDIA</b>		
<b>DATE OF REGISTRATION</b>	27/02/2013	
<b>TITLE</b>	ELECTRICAL TOOL FOR ORTHOPEDIC SURGERY	
<b>PRIORITY NA</b>		

<b>DESIGN NUMBER</b>	249943	
<b>CLASS</b>	09-07	
<b>1)MONO PACKAGING PVT. LTD., 506/A, SHREENATH COMPLEX, P. K. ROAD EXTENSION, MULUND (WEST), MUMBAI-400080, INDIA. (AN INDIAN COMPANY DULY REGISTERED UNDER THE COMPANIES ACT, 1956)</b>		
<b>DATE OF REGISTRATION</b>	05/12/2012	
<b>TITLE</b>	BOTTLE CAP	
<b>PRIORITY NA</b>		

<b>DESIGN NUMBER</b>	251622	
<b>CLASS</b>	26-05	
<b>1)GE INDIA INDUSTRIAL PRIVATE LIMITED., AN INDIAN COMPANY REGISTERED UNDER THE COMPANIES ACT 1956 HAVING ITS REGISTERED OFFICE AT PLOT NO. 42/1 &amp; 45/14, ELECTRONIC CITY PHASE II BANGALORE 560100, KARNATAKA, INDIA; NATIONALITY: IN</b>		
<b>DATE OF REGISTRATION</b>	13/02/2013	
<b>TITLE</b>	LIGHTING APPARATUS	
<b>PRIORITY NA</b>		

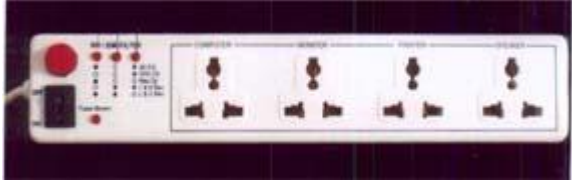
<b>DESIGN NUMBER</b>	250486		
<b>CLASS</b>	09-01		
<b>1)HINDUSTAN UNILEVER LIMITED, A COMPANY INCORPORATED UNDER THE INDIAN COMPANIES ACT, 1913, HAVING ITS REGISTERED OFFICE AT UNILEVER HOUSE, B. D. SAWANT MARG, CHAKALA, ANDHERI (EAST), MUMBAI 400 099, STATE OF MAHARASHTRA, INDIA</b>			
<b>DATE OF REGISTRATION</b>	26/12/2012		
<b>TITLE</b>	BOTTLE		
<b>PRIORITY</b>			
<b>PRIORITY NUMBER</b>	<b>DATE</b>	<b>COUNTRY</b>	
001333041	02/07/2012	OHIM	

<b>DESIGN NUMBER</b>	249090	
<b>CLASS</b>	13-03	
<b>1)1) MR. LALIT T. GWALANI AND 2) MRS. SUNITA R. GWALANI, PARTNERS-INDIAN NATIONAL, TRADING AS DOSSAN ENGINEERING COMPANY, A REGISTERED PARTNERSHIP FIRM IN INDIA, HAVING ITS REGISTERED OFFICE AT 205, BAJSON INDUSTRIAL ESTATE, 40, CHAKALA ROAD, ANDHERI (EAST), MUMBAI 400 099, STATE OF MAHARASHTRA, INDIA, OF ABOVE ADDRESS</b>		
<b>DATE OF REGISTRATION</b>	30/10/2012	
<b>TITLE</b>	POWER EXTENSION SOCKET	
<b>PRIORITY NA</b>		
<b>DESIGN NUMBER</b>	251057	
<b>CLASS</b>	12-11	
<b>1)HERO CYCLES LIMITED, HERO NAGAR, G. T. ROAD, LUDHIANA-141003 (PUNJAB), INDIA, (AN INDIAN COMPANY DULY INCORPORATED UNDER THE PROVISIONS OF INDIAN COMPANIES ACT, 1956)</b>		
<b>DATE OF REGISTRATION</b>	21/01/2013	
<b>TITLE</b>	BICYCLE	
<b>PRIORITY NA</b>		
<b>DESIGN NUMBER</b>	249428	
<b>CLASS</b>	12-16	
<b>1)CONCENTRIC PUMPS PUNE PVT. LTD. A COMPANY REGISTERED UNDER COMPANY ACT 1956 OF GAT NO. 26/1, 27 &amp; 28 (PART), OFF PUNE-NAGAR ROAD, VILLAGE LONIKAND, P.O. LONIKAND, TALUKA HAVELI, PUNE-412216, MAHARASHTRA, INDIA</b>		
<b>DATE OF REGISTRATION</b>	12/11/2012	
<b>TITLE</b>	ENGINE COOLING WATER PUMP	
<b>PRIORITY NA</b>		



<b>DESIGN NUMBER</b>	249581	
<b>CLASS</b>	11-01	
<b>1)DEREWALA JEWELLERY INDUSTRIES LTD. (NATIONALITY-INDIAN)</b> AT-E-73, EPIP, SITAPURA INDUSTRIAL AREA, TONK ROAD, JAIPUR (RAJ.) NATIONALITY-INDIAN		
<b>DATE OF REGISTRATION</b>	20/11/2012	
<b>TITLE</b>	PENDANT	
<b>PRIORITY NA</b>		

<b>DESIGN NUMBER</b>	251730	
<b>CLASS</b>	09-07	
<b>1)NATIONAL PLASTICS,</b> 91 BASANT AVENUE, AMRITSAR-143011, INDIA, AN INDIAN COMPANY		
<b>DATE OF REGISTRATION</b>	18/02/2013	
<b>TITLE</b>	CAP	
<b>PRIORITY NA</b>		

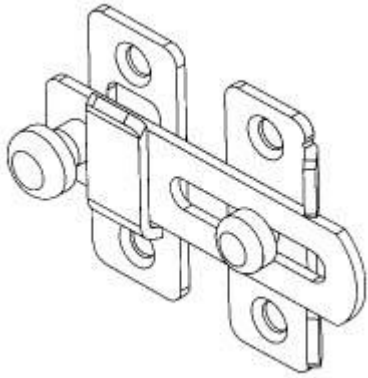
<b>DESIGN NUMBER</b>	251829	
<b>CLASS</b>	08-07	
<b>1)EBCO PVT. LTD., A COMPANY INCORPORATED UNDER THE INDIAN COMPANIES ACT, AT</b> 402-3, HYDE PARK, SAKI VIHAR ROAD, MUMBAI-400072, MAHARASHTRA, INDIA.		
<b>DATE OF REGISTRATION</b>	22/02/2013	
<b>TITLE</b>	DOOR LATCH	
<b>PRIORITY NA</b>		

<b>DESIGN NUMBER</b>	248918		
<b>CLASS</b>	09-01		
1)BASF SE, A GERMAN COMPANY OF 67056, LUDWIGSHAFEN, GERMANY			
<b>DATE OF REGISTRATION</b>	19/10/2012		
<b>TITLE</b>	BOTTLE		
<b>PRIORITY NA</b>			
<b>DESIGN NUMBER</b>	250945		
<b>CLASS</b>	12-16		
1)FORD GLOBAL TECHNOLOGIES, LLC A COMPANY ORGANIZED AND EXISTING UNDER THE LAWS OF UNITED STATES OF AMERICA, HAVING ITS OFFICE AT SUITE 800, 330 TOWN CENTER DRIVE, DEARBORN MICHIGAN-48126, UNITED STATES OF AMERICA			
<b>DATE OF REGISTRATION</b>	10/01/2013		
<b>TITLE</b>	VEHICLE WHEEL RIM		
<b>PRIORITY</b>			
<b>PRIORITY NUMBER</b>	<b>DATE</b>	<b>COUNTRY</b>	
402012100596.0	02/08/2012	GERMANY	
<b>DESIGN NUMBER</b>	250536		
<b>CLASS</b>	31-00		
1)KONINKLIJKE PHILIPS ELECTRONICS N.V., A COMPANY ORGANIZED AND EXISTING UNDER THE LAWS OF THE KINGDOM OF THE NETHERLANDS, RESIDING AT EINDHOVEN, WHOSE POST-OFFICE ADDRESS IS GROENEWOUDSEWEG 1, 5621 BA, EINDHOVEN, THE NETHERLANDS			
<b>DATE OF REGISTRATION</b>	31/12/2012		
<b>TITLE</b>	ELECTRIC MIXER		
<b>PRIORITY</b>			
<b>PRIORITY NUMBER</b>	<b>DATE</b>	<b>COUNTRY</b>	
002066878-0002	02/07/2012	OHIM	



<b>DESIGN NUMBER</b>	251234	
<b>CLASS</b>	28-99	
<b>1)HINDUSTAN UNILEVER LIMITED, A COMPANY INCORPORATED UNDER THE INDIAN COMPANIES ACT, 1913, HAVING ITS REGISTERED OFFICE AT</b> UNILEVER HOUSE, B. D. SAWANT MARG, CHAKALA, ANDHERI (EAST), MUMBAI 400 099, STATE OF MAHARASHTRA, INDIA		
<b>DATE OF REGISTRATION</b>	28/01/2013	
<b>TITLE</b>	DETERGENT BAR	
<b>PRIORITY</b>		
<b>PRIORITY NUMBER</b>	<b>DATE</b>	<b>COUNTRY</b>
002080333-0001	27/07/2012	OHIM

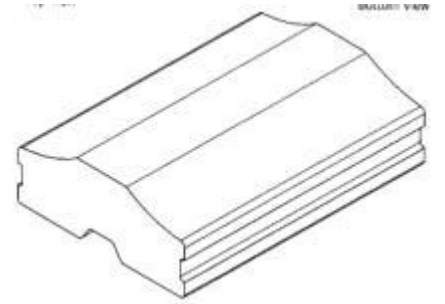

<b>DESIGN NUMBER</b>	251243	
<b>CLASS</b>	26-05	
<b>1)GE INDIA INDUSTRIAL PRIVATE LIMITED., AN INDIAN COMPANY REGISTERED UNDER THE COMPANIES ACT 1956 HAVING ITS REGISTERED OFFICE AT</b> PLOT NO. 42/1 & 45/14, ELECTRONIC CITY PHASE II, BANGALORE-560100, KARNATAKA, INDIA; NATIONALITY: IN		
<b>DATE OF REGISTRATION</b>	29/01/2013	
<b>TITLE</b>	LIGHTING APPARATUS	
<b>PRIORITY NA</b>		

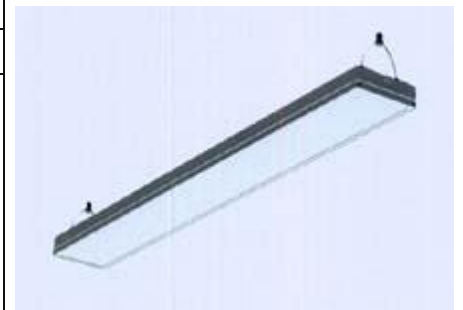

<b>DESIGN NUMBER</b>	251292	
<b>CLASS</b>	08-09	
<b>1)RAKESHBHAI VITTHALBHAI BHALARA AN INDIAN NATIONAL SOLE PROPRIETOR OF DIVINE OVERSEAS INDIA AN INDIAN PROPRIETORSHIP FIRM HAVING ITS PRINCIPAL PLACE OF BUSINESS AT</b> PLOT NO. 4, SURVEY NO. 229, OPP. SARDAR CASTING, B/H. PARIN FURNITURE, DHOLRA ROAD, GONDAL HIGHWAY, RAJKOT, GUJARAT-INDIA		
<b>DATE OF REGISTRATION</b>	29/01/2013	
<b>TITLE</b>	GLASS PATCH FITTINGS	
<b>PRIORITY NA</b>		



<b>DESIGN NUMBER</b>	251301	
<b>CLASS</b>	15-03	
<b>1)PUBERT HENRI SAS., OF</b> ROUTE DE POUZAUGES-ZI DE PIERRE BRUNE, 85110 CHANTONNAY, FRANCE, NATIONALITY: FRENCH		
<b>DATE OF REGISTRATION</b>	30/01/2013	
<b>TITLE</b>	MOTOR HOE	
<b>PRIORITY NA</b>		
<b>DESIGN NUMBER</b>	248129	
<b>CLASS</b>	08-07	
<b>1)MAHESHBHAI M. VADGAMA AN INDIAN NATIONAL SOLE PROPRIETOR</b> <b>OF AMAR HARDWARE PRODUCTS AN INDIAN PROPRIETORSHIP FIRM</b> <b>HAVING ITS PRINCIPAL PLACE OF BUSINESS</b> AT SAMRAT INDUSTRIAL AREA, 50 FEET MAIN ROAD, NEAR TECHNO HYDRAULIC, B/H. S.T. WORKSHOP, RAJKOT, GUJARAT-INDIA.		
<b>DATE OF REGISTRATION</b>	25/09/2012	
<b>TITLE</b>	TOWER BOLT	
<b>PRIORITY NA</b>		
<b>DESIGN NUMBER</b>	246873	
<b>CLASS</b>	09-01	
<b>1)INTERNATIONAL FOODSTUFFS COMPANY (LIMITED LIABILITY</b> <b>COMPANY, UNDER THE LAWS OF UNITED ARAB EMIRATES) HAVING</b> <b>ADDRESS</b> AT POST BOX NO. 4115, SHARJAH, UNITED ARAB EMIRATES		
<b>DATE OF REGISTRATION</b>	01/08/2012	
<b>TITLE</b>	CARBOY	
<b>PRIORITY NA</b>		

<b>DESIGN NUMBER</b>	249422	
<b>CLASS</b>	13-01	
<b>1)YOUWINENERGY GMBH, A COMPANY ORGANIZED AND EXISTING UNDER THE LAWS OF GERMANY, HAVING ITS OFFICE AT RUDOLF-DIESEL-STR. 9, D-26135 OLDENBURG, ALEMANIA, GERMANY</b>		
<b>DATE OF REGISTRATION</b>	09/11/2012	
<b>TITLE</b>	NACELLE OF WIND TURBINE	
<b>PRIORITY</b>		
<b>PRIORITY NUMBER</b>	<b>DATE</b>	<b>COUNTRY</b>
002103267	14/09/2012	OHIM

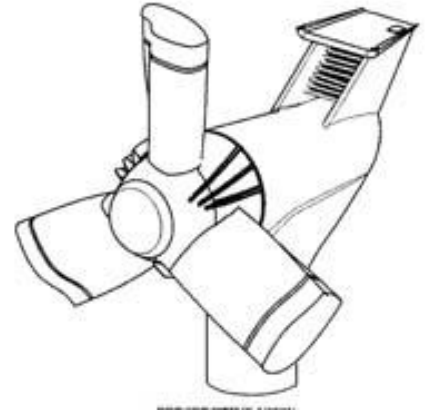





<b>DESIGN NUMBER</b>	249576	
<b>CLASS</b>	11-01	
<b>1)DEREWALA JEWELLERY INDUSTRIES LTD. (NATIONALITY-INDIAN) AT-E-73, EPIP, SITAPURA INDUSTRIAL AREA, TONK ROAD, JAIPUR (RAJ.) NATIONALITY-INDIAN.</b>		
<b>DATE OF REGISTRATION</b>	20/11/2012	
<b>TITLE</b>	PENDANT	
<b>PRIORITY NA</b>		

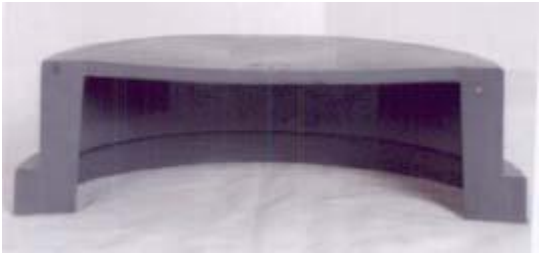
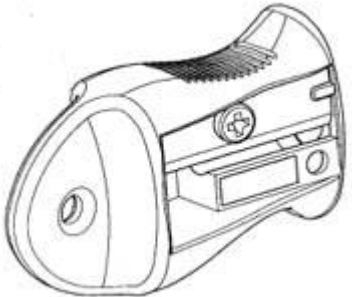

<b>DESIGN NUMBER</b>	251746	
<b>CLASS</b>	08-06	
<b>1)MUKESHBHAI GORDHANBHAI RAKHOLIYA (ADULT AND INDIAN NATIONAL) AND SOLE PROPRIETOR OF RAMESHWAR METAL (INDIAN PROPRIETORSHIP CONCERN) HAVING PLACE OF BUSINESS AT- 4, PARSANA SOCIETY, 50 FEET MAIN ROAD, B/H. 73 NUMBERS SCHOOL, RAJKOT-GUJARAT-(INDIA)</b>		
<b>DATE OF REGISTRATION</b>	19/02/2013	
<b>TITLE</b>	HANDLE	
<b>PRIORITY NA</b>		





<b>DESIGN NUMBER</b>	251956	
<b>CLASS</b>	06-03	
<b>1)GODREJ &amp; BOYCE MFG. CO. LTD., AN INDIAN COMPANY INCORPORATED UNDER THE COMPANIES ACT, 1913, OF GODREJ INTERIO, PLANT 4, PIROJSHANAGER, VIKHROLI (WEST), MUMBAI-400079, INDIA</b>		
<b>DATE OF REGISTRATION</b>	01/03/2013	
<b>TITLE</b>	DESK	
<b>PRIORITY NA</b>		
<b>DESIGN NUMBER</b>	246927	
<b>CLASS</b>	23-01	
<b>1)SATISH M. BOTHARA SOLE PROPRIETOR OF GAURAV AGRO PIPES OF S. NO. 80, 10TH MILE STONE, NAGAR-KALYAN ROAD, A/P-BHALWANI, TAL-PARNER, DIST. AHMEDNAGAR-414 103, MAHARASHTRA, INDIA, INDIAN COMPANY</b>		
<b>DATE OF REGISTRATION</b>	03/08/2012	
<b>TITLE</b>	STOP END FOR PIPE FITTING	
<b>PRIORITY NA</b>		
<b>DESIGN NUMBER</b>	251161	
<b>CLASS</b>	19-06	
<b>1)SDI CORPORATION, A COMPANY OF TAIWAN, R.O.C. OF NO. 260, SEC. 2, CHANG NAN RD., CHANG HUA, TAIWAN, R.O.C.</b>		
<b>DATE OF REGISTRATION</b>	23/01/2013	
<b>TITLE</b>	PENCIL SHARPENER	
<b>PRIORITY NA</b>		

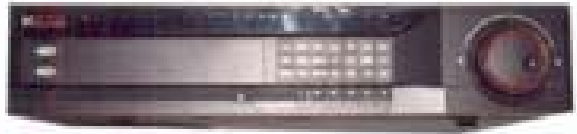

<b>DESIGN NUMBER</b>	251178	
<b>CLASS</b>	08-06	
<b>1)HITESHBHAI VINODBHAI GHIYA (ADULT, &amp; INDIAN NATIONAL)          PROPRIETOR OF HITESH TRADERS HAVING PLACE OF BUSINESS AT :          "SHRI SWAMINARAYAN KRUPA □ KOTHARIYA MAIN ROAD, B/H PUNIT          SOCIETY, 5-GOKUL NAGAR, RAJKOT-360002 GUJARAT (INDIA)</b>		
<b>DATE OF REGISTRATION</b>	24/01/2013	
<b>TITLE</b>	HANDLE	
<b>PRIORITY NA</b>		
<b>DESIGN NUMBER</b>	248913	
<b>CLASS</b>	09-01	
<b>1)BASF SE, A GERMAN COMPANY OF          67056, LUDWIGSHAFEN, GERMANY</b>		
<b>DATE OF REGISTRATION</b>	19/10/2012	
<b>TITLE</b>	BOTTLE	
<b>PRIORITY NA</b>		
<b>DESIGN NUMBER</b>	245868	
<b>CLASS</b>	02-01	
<b>1)SUMAN BHARTI,          PLOT-510, UDHTOG VIHAR PHASE-5, GURGAON-122016, HARYANA, INDIA, A          CITIZEN OF INDIA</b>		
<b>DATE OF REGISTRATION</b>	12/06/2012	
<b>TITLE</b>	CORSET	
<b>PRIORITY NA</b>		

<b>DESIGN NUMBER</b>	250876		
<b>CLASS</b>	26-06		
<b>1)FORD GLOBAL TECHNOLOGIES, LLC A COMPANY ORGANIZED AND EXISTING UNDER THE LAWS OF UNITED STATES OF AMERICA, HAVING ITS OFFICE AT</b> SUITE 800, 330 TOWN CENTER DRIVE, DEARBORN MICHIGAN-48126, UNITED STATES OF AMERICA			
<b>DATE OF REGISTRATION</b>	09/01/2013		
<b>TITLE</b>	VEHICLE TAILLIGHT		
<b>PRIORITY</b>			
<b>PRIORITY NUMBER</b>	<b>DATE</b>	<b>COUNTRY</b>	
402012100597.9	02/08/2012	GERMANY	
<b>DESIGN NUMBER</b>	250943		
<b>CLASS</b>	12-16		
<b>1)FORD GLOBAL TECHNOLOGIES, LLC A COMPANY ORGANIZED AND EXISTING UNDER THE LAWS OF UNITED STATES OF AMERICA, HAVING ITS OFFICE AT</b> SUITE 800, 330 TOWN CENTER DRIVE, DEARBORN MICHIGAN-48126, UNITED STATES OF AMERICA			
<b>DATE OF REGISTRATION</b>	10/01/2013		
<b>TITLE</b>	VEHICLE WHEEL RIM		
<b>PRIORITY</b>			
<b>PRIORITY NUMBER</b>	<b>DATE</b>	<b>COUNTRY</b>	
402012100596.0	02/08/2012	GERMANY	
<b>DESIGN NUMBER</b>	250469		
<b>CLASS</b>	06-01		
<b>1)GODREJ &amp; BOYCE MFG. CO. LTD., AN INDIAN COMPANY INCORPORATED UNDER THE COMPANIES ACT 1913, OF</b> GODREJ INTERIO, PLANT 4, PIROJSHANAGER, VIKHROLI (WEST), MUMBAI-400079, INDIA			
<b>DATE OF REGISTRATION</b>	26/12/2012		
<b>TITLE</b>	SOFA		
<b>PRIORITY NA</b>			

<b>DESIGN NUMBER</b>	249734	
<b>CLASS</b>	14-01	
<b>1)ADITYA INFOTECH LIMITED, KHEMKA CENTRE, 2-5, NEHRU PLACE, NEW DELHI 110019, DELHI STATE, INDIA, A LIMITED COMPAY INCORPORATED UNDER THE INDIAN COMPANIES ACT, 1956</b>		
<b>DATE OF REGISTRATION</b>	27/11/2012	
<b>TITLE</b>	DIGITAL VIDEO RECORDER	
<b>PRIORITY NA</b>		

<b>DESIGN NUMBER</b>	251395	
<b>CLASS</b>	08-06	
<b>1)PIYUSHBHAI DILIPBHAI DHOLARIYA (ADULT, &amp; INDIAN NATIONAL) PROPRIETOR OF FLOWTECH INDUSTRIES HAVING PLACE OF BUSINESS AT : 7, PARSANA SOCIETY, 50 FOOT ROAD, NEAR SORATHIYAWADI CIRCLE, RAJKOT-GUJARAT (INDIA)</b>		
<b>DATE OF REGISTRATION</b>	05/02/2013	
<b>TITLE</b>	HANDLE	
<b>PRIORITY NA</b>		

<b>DESIGN NUMBER</b>	246820	<div style="text-align: right; font-size: small;">Sheet No.:01</div>  <div style="text-align: center; font-size: x-small;">Perspective view</div>
<b>CLASS</b>	09-01	
<b>1)ITC LIMITED, AN INDIAN COMPANY WITHIN THE MEANING OF THE COMPANIES ACT, 1956 OF VIRGINIA HOUSE, 37, J. L. NEHRU ROAD, KOLKATA - 700071, WEST BENGAL, INDIA</b>		
<b>DATE OF REGISTRATION</b>	30/07/2012	
<b>TITLE</b>	JAR	
<b>PRIORITY NA</b>		

<b>DESIGN NUMBER</b>	249595	
<b>CLASS</b>	06-13	
<b>1)SARITA HANDA DESIGN WORKS PVT. LTD., AN INDIAN COMPANY OF D-11, DEFENCE COLONY, NEW DELHI-110024, INDIA</b>		
<b>DATE OF REGISTRATION</b>	20/11/2012	
<b>TITLE</b>	PILLOW COVER	
<b>PRIORITY NA</b>		
<b>DESIGN NUMBER</b>	251751	
<b>CLASS</b>	08-06	
<b>1)MUKESHBHAI GORDHANBHAI RAKHOLIYA (ADULT AND INDIAN NATIONAL) AND SOLE PROPRIETOR OF RAMESHWAR METAL (INDIAN PROPRIETORSHIP CONCERN) HAVING PLACE OF BUSINESS AT- 4, PARSANA SOCIETY, 50 FEET MAIN ROAD, B/H. 73 NUMBERS SCHOOL, RAJKOT-GUJARAT-(INDIA)</b>		
<b>DATE OF REGISTRATION</b>	19/02/2013	
<b>TITLE</b>	HANDLE	
<b>PRIORITY NA</b>		
<b>DESIGN NUMBER</b>	249321	
<b>CLASS</b>	08-02	
<b>1)NATIONAL INSTITUTE OF DESIGN LOCATED AT PALDI, AHMEDABAD 380007, GUJARAT, HAVING NATIONALITY AS INDIAN</b>		
<b>DATE OF REGISTRATION</b>	08/11/2012	
<b>TITLE</b>	NAIL GUN	
<b>PRIORITY NA</b>		



<b>DESIGN NUMBER</b>	251122		
<b>CLASS</b>	12-16		
<b>1)BAJAJ AUTO LIMITED, AN INDIAN COMPANY, INCORPORATED UNDER THE COMPANIES ACT OF 1956, HAVING ITS PRINCIPAL PLACE OF BUSINESS AT NEW 2ND &amp; 3RD FLOOR, KHIVRAJ BUILDING,</b> NO. 616, ANNASALAI, CHENNAI - 600006, STATE OF TAMIL NADU, INDIA, AND REGISTERED OFFICE AT AKURDI, PUNE-411035, STATE OF MAHARASHTRA, INDIA			
<b>DATE OF REGISTRATION</b>	22/01/2013		
<b>TITLE</b>	WHEEL RIM FOR VEHICLE		
<b>PRIORITY NA</b>			
<b>DESIGN NUMBER</b>	248858		
<b>CLASS</b>	28-03		
<b>1)LASER SHAVING (INDIA) PRIVATE LIMITED, A COMPANY DULY ORGANIZED UNDER THE INDIAN COMPANIES ACT, 1956 AND HAVING ITS REGISTERED OFFICE AT</b> MALHOTRA HOUSE, 6-3-1186, BEGUMPET, HYDERABAD 500016, ANDHRA PRADESH, INDIA.			
<b>DATE OF REGISTRATION</b>	17/10/2012		
<b>TITLE</b>	RAZOR		
<b>PRIORITY NA</b>			
<b>DESIGN NUMBER</b>	245810		
<b>CLASS</b>	23-01		
<b>1)JOHN GUEST INTERNATIONAL LIMITED OF</b> HORTON ROAD, WEST DRAYTON, MIDDLESSEX UB7 8JL, UNITED KINGDOM			
<b>DATE OF REGISTRATION</b>	08/06/2012		
<b>TITLE</b>	CONNECTOR FOR CABLES AND DUCTS		
<b>PRIORITY</b>			
<b>PRIORITY NUMBER</b>	<b>DATE</b>	<b>COUNTRY</b>	
001306047-0004	09/12/2011	OHIM	

<b>DESIGN NUMBER</b>	248474			
<b>CLASS</b>	12-13			
<b>1)KUMIKO UCHIYAMA,</b> 1-12-1-2210, NUMAKAGE, MINAMI-KU, SAITAMA, SAITAMA 336-0027, JAPAN, A JAPANESE NATIONAL				
<b>DATE OF REGISTRATION</b>	04/10/2012			
<b>TITLE</b>	ELECTRIC CART			
<b>PRIORITY</b>				
<b>PRIORITY NUMBER</b>	<b>DATE</b>	<b>COUNTRY</b>		
201230099813.2	09/04/2012	CHINA		
<b>PRIORITY NA</b>				
<b>PRIORITY NA</b>				
<b>DESIGN NUMBER</b>	248596			
<b>CLASS</b>	06-04			
<b>1)BUTTERFLY METAL PVT. LTD. (A COMPANY INCORPORATED UNDER THE COMPANIES ACT, 1956) HAVING ITS PRINCIPAL PLACE OF BUSINESS AT PLOT NO. G-733, G.I.D.C., LODHIKA, KALAWAD ROAD, NR. TELEPHONE EXCHANGE, METODA, RAJKOT-360003 GUJARAT-INDIA.</b>				
<b>DATE OF REGISTRATION</b>	12/10/2012			
<b>TITLE</b>	STORAGE FURNITURE			
<b>PRIORITY NA</b>				
<b>PRIORITY NA</b>				
<b>DESIGN NUMBER</b>	250818			
<b>CLASS</b>	13-03			
<b>1)LARSEN &amp; TOUBRO LIMITED, AN INDIAN COMPANY INCORPORATED UNDER THE COMPANIES ACT, 1956 OF L &amp; T HOUSE, BALLARD ESTATE, MUMBAI 400001, STATE OF MAHARASHTRA, INDIA</b>				
<b>DATE OF REGISTRATION</b>	07/01/2013			
<b>TITLE</b>	MOULDED CASE CIRCUIT BREAKER			
<b>PRIORITY NA</b>				

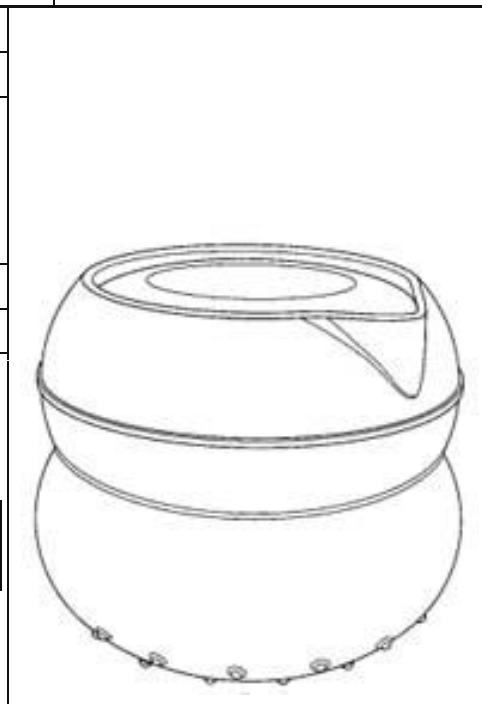

<b>DESIGN NUMBER</b>	251579	
<b>CLASS</b>	11-02	
<b>1)VIBHOR SOGANI, AN INDIAN NATIONAL, OF THE ADDRESS</b> A-47/10, G.F. D.L.F. PHASE-I, GURGAON-122001, HARYANA, INDIA		
<b>DATE OF REGISTRATION</b>	11/02/2013	
<b>TITLE</b>	DECORATIVE ARTICLE	
<b>PRIORITY NA</b>		

<b>DESIGN NUMBER</b>	250488	
<b>CLASS</b>	09-01	
<b>1)HINDUSTAN UNILEVER LIMITED, A COMPANY INCORPORATED UNDER THE INDIAN COMPANIES ACT, 1913, HAVING ITS REGISTERED OFFICE AT</b> UNILEVER HOUSE, B. D. SAWANT MARG, CHAKALA, ANDHERI (EAST), MUMBAI 400099, STATE OF MAHARASHTRA, INDIA		
<b>DATE OF REGISTRATION</b>	26/12/2012	
<b>TITLE</b>	BOTTLE	
<b>PRIORITY</b>		
<b>PRIORITY NUMBER</b>	<b>DATE</b>	<b>COUNTRY</b>
001333041	02/07/2012	OHIM





<b>DESIGN NUMBER</b>	250561	
<b>CLASS</b>	12-11	
<b>1)HONDA MOTOR CO., LTD., A JAPANESE CORPORATION, OF</b> 1-1, MINAMIAOYAMA 2-CHOME, MINATO-KU, TOKYO, JAPAN		
<b>DATE OF REGISTRATION</b>	31/12/2012	
<b>TITLE</b>	MOTORCYCLE	
<b>PRIORITY</b>		
<b>PRIORITY NUMBER</b>	<b>DATE</b>	<b>COUNTRY</b>
2012-017030	18/07/2012	JAPAN



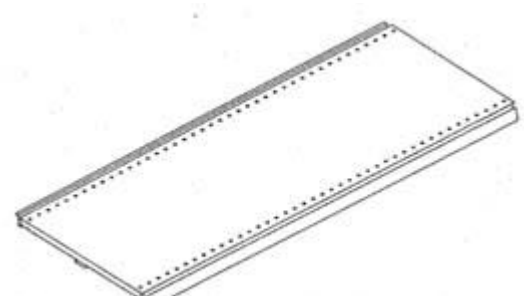

<b>DESIGN NUMBER</b>	232669	
<b>CLASS</b>	02-02	
<b>1)MAHOTSAV CREATION PVT. LTD., "MAHOTSAV HOUSE" NO.6, RATHI PALACE, RING ROAD, SURAT-385002, GUJARAT</b>		
<b>DATE OF REGISTRATION</b>	16/11/2010	
<b>TITLE</b>	SAREE AND BLOUSE SET	
<b>PRIORITY NA</b>		
<b>DESIGN NUMBER</b>	247004	
<b>CLASS</b>	26-02	
<b>1)SPECTRUM TOOL ENGINEERS PRIVATE LIMITED, AN INDIAN COMPANY OF # 97 &amp; 100, PETECHANNAPPA INDUSTRIAL ESTATE, KAMAKSHIPALYA, MAGADI MAIN ROAD, BANGALORE 560079, STATE OF KARNATAKA, INDIA, AN INDIAN COMPANY</b>		
<b>DATE OF REGISTRATION</b>	06/08/2012	
<b>TITLE</b>	EMERGENCY LIGHT	
<b>PRIORITY NA</b>		
<b>DESIGN NUMBER</b>	249035	
<b>CLASS</b>	28-03	
<b>1)(1)MANOJKUMAR CHANDULAL RANPARA OF (2)TUSHARBHAI MANOJKUMAR RANPARA (3)DEVANGBHAI MANOJKUMAR RANPARA (ALL PARTNER ARE ADULT AND INDIAN NATIONAL) PARTNER OF NEW RANPARA INDUSTRIES HAVING PLACE OF BUSINESS AT -8, LATI PLOT, MORBI, DIST:RAJKOT-GUJARAT (INDIA)</b>		
<b>DATE OF REGISTRATION</b>	29/10/2012	
<b>TITLE</b>	TONGUE CLEANER	
<b>PRIORITY NA</b>		

<b>DESIGN NUMBER</b>	249159	
<b>CLASS</b>	25-02	
<b>1)THE SUPREME INDUSTRIES LTD., (AN INDIAN PUBLIC LIMITED COMPANY),</b> 601, CENTRAL PLAZA, 2/6 SARAT BOSE ROAD, KOLKATA - 700020, WEST BENGAL, INDIA		
<b>DATE OF REGISTRATION</b>	01/11/2012	
<b>TITLE</b>	MANHOLE	
<b>PRIORITY NA</b>		

<b>DESIGN NUMBER</b>	249255	
<b>CLASS</b>	06-06	
<b>1)TEGOMETALL INTERNATIONAL AG,</b> OF INDUSTRIESTRASSE 7, 8574 LENGWIL, SWITZERLAND		
<b>DATE OF REGISTRATION</b>	05/11/2012	
<b>TITLE</b>	RACK SHELF	
<b>PRIORITY</b>		
<b>PRIORITY NUMBER</b>	<b>DATE</b>	<b>COUNTRY</b>
001324768-001	04/05/2012	OHIM



<b>DESIGN NUMBER</b>	251121	
<b>CLASS</b>	12-16	
<b>1)BAJAJ AUTO LIMITED, AN INDIAN COMPANY, INCORPORATED UNDER THE COMPANIES ACT OF 1956, HAVING ITS PRINCIPAL PLACE OF BUSINESS AT NEW 2ND &amp; 3RD FLOOR, KHIVRAJ BUILDING,</b> NO. 616, ANNASALAI, CHENNAI - 600006, STATE OF TAMIL NADU, INDIA, AND REGISTERED OFFICE AT AKURDI, PUNE-411035, STATE OF MAHARASHTRA, INDIA		
<b>DATE OF REGISTRATION</b>	22/01/2013	
<b>TITLE</b>	WHEEL RIM FOR VEHICLE	
<b>PRIORITY NA</b>		



<b>DESIGN NUMBER</b>	251173	
<b>CLASS</b>	08-06	
<b>1)(1) RAMESHBHAI PANCHABHAI PAMBHAR (2) MAGANBHAI PANCHABHAI PAMBHAR (3) TRIBHOVANBHAI PANCHABHAI PAMBHAR (ALL PARTNERS ARE INDIAN NATIONALS) PARTNERS OF SHREE KHODIYAR INDUSTRIES (REGISTERED UNDER THE INDIAN PARTNERSHIP ACT-1932) HAVING PLACE OF BUSINESS AT : 2/8, GOKULNAGAR, 50 FEET ROAD, RAJKOT-360002 GUJARAT (INDIA)</b>		
<b>DATE OF REGISTRATION</b>	24/01/2013	
<b>TITLE</b>	HANDLE	
<b>PRIORITY NA</b>		

<b>DESIGN NUMBER</b>	250808		
<b>CLASS</b>	02-04		
<b>1)ALPARGATAS S.A., A CORPORATION ORGANIZED AND EXISTING UNDER THE LAWS OF THE BRAZIL WHO ARE BRAZILIAN BY NATIONALITY AND WHOSE ADDRESS IS AVENIDA DOUTOR CARDOSO DE MELO 1336, VILA OLIMPIA, SÃO PAULO, SP, BRAZI, CEP : 04548-005</b>			
<b>DATE OF REGISTRATION</b>	07/01/2013		
<b>TITLE</b>	SHOE		
<b>PRIORITY</b>			
<b>PRIORITY NUMBER</b>	<b>DATE</b>	<b>COUNTRY</b>	
002088955	17/08/2012	OHIM	

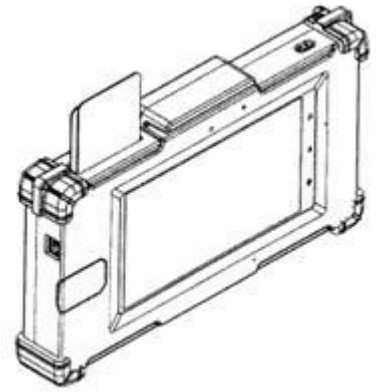
<b>DESIGN NUMBER</b>	246625		
<b>CLASS</b>	26-05		
<b>1)PRUDENT SYSTEMS PVT. LTD., C/O. RAKESH KUMAR SINGH, 302/27, ADITYA NAGAR, INDORE, MADHYA PRADESH, PIN-452001 INDIA AN INDIAN COMPANY</b>			
<b>DATE OF REGISTRATION</b>	20/07/2012		
<b>TITLE</b>	SOLAR LAMP		
<b>PRIORITY NA</b>			



<b>DESIGN NUMBER</b>	249442	
<b>CLASS</b>	09-01	
<b>1) V. B. INDUSTRIES, PLOT NO. 64/65/66, DAMAN INDUSTRIAL ESTATE, NEAR FIRE STATION, SOMNATH ROAD, DAMAN 396210, (U.T.), INDIA, A PARTNERSHIP FIRM REGISTERED UNDER THE INDIAN PARTNERSHIP ACT, WHOSE PARTNERS ARE (1) BHAWARLAL MANGILAL JAIN, (2) PRAVIN BHAWARLAL JAIN (3) NARESH BHAWARLAL JAIN, ALL OF INDIAN NATIONALITY,</b> RESIDENT OF 92/2, JAWAHAR NAGAR, ROAD NO. 5, GOREGAON WEST, MUMBAI 400062, MAHARASHTRA, INDIA		
<b>DATE OF REGISTRATION</b>	12/11/2012	
<b>TITLE</b>	BOTTLE WITH CAP	
<b>PRIORITY NA</b>		
<b>DESIGN NUMBER</b>	249514	
<b>CLASS</b>	14-02	
<b>1) BEWO TECHNOLOGIES PVT. LTD</b> #803-804, PRESTIGE MERIDIAN II, M. G. ROAD, BANGALORE-560001		
<b>DATE OF REGISTRATION</b>	16/11/2012	
<b>TITLE</b>	CASING FOR TABLET DEVICE	
<b>PRIORITY NA</b>		
<b>DESIGN NUMBER</b>	249594	
<b>CLASS</b>	06-13	
<b>1) SARITA HANDA DESIGN WORKS PVT. LTD., AN INDIAN COMPANY OF D-11, DEFENCE COLONY, NEW DELHI-110024, INDIA</b>		
<b>DATE OF REGISTRATION</b>	20/11/2012	
<b>TITLE</b>	DUVET	
<b>PRIORITY NA</b>		

<b>DESIGN NUMBER</b>	251874		
<b>CLASS</b>	12-11		
<b>1)S. R. TOOL INDUSTRIES OF SUA ROAD, EASTMAN CHOWK, JASPAL BANGAR ROAD, LUDHIANA-141010 (PUNJAB), INDIA,</b> AN INDIAN PROPRIETORSHIP FIRM WHOSE PROPRIETOR IS SHRI RAM, AN INDIAN NATIONAL OF ABOVE ADDRESS			
<b>DATE OF REGISTRATION</b>	26/02/2013		
<b>TITLE</b>	RIM FOR TRICYCLES		
<b>PRIORITY NA</b>			
<b>DESIGN NUMBER</b>	251898		
<b>CLASS</b>	07-07		
<b>1)NAYASA WORLD OF SURVEY NO. 655/1C NEAR SOMNANATH CO.OP.SOCIETY, DABHEL NANI DAMAN, DAMAN-396 310, (UNION TERRITORIES) DAMAN, INDIA,</b> INDIAN PARTNERSHIP FIRM, WHOSE PARTNERS ARE RUPA SACHDEV, MANASI SACHDEV & KISHOR MALIK, ALL INDIAN NATIONALS			
<b>DATE OF REGISTRATION</b>	27/02/2013		
<b>TITLE</b>	TIFFIN BOX		
<b>PRIORITY NA</b>			
<b>DESIGN NUMBER</b>	250209		
<b>CLASS</b>	12-11		
<b>1)HONDA MOTOR CO., LTD., A JAPANESE CORPORATION, OF 1-1, MINAMIAOYAMA 2-CHOME, MINATO-KU, TOKYO, JAPAN</b>			
<b>DATE OF REGISTRATION</b>	17/12/2012		
<b>TITLE</b>	MOTOR SCOOTER		
<b>PRIORITY</b>			
<b>PRIORITY NUMBER</b>	<b>DATE</b>	<b>COUNTRY</b>	
2012-014634	20/06/2012	JAPAN	
<b>PRIORITY NA</b>			
<b>PRIORITY NA</b>			



<b>DESIGN NUMBER</b>	245809	
<b>CLASS</b>	23-01	
<b>1)JOHN GUEST INTERNATION LIMITED OF</b> HORTON ROAD, WEST DRAYTON, MIDDLESSEX UB7 8JL, UNITED KINGDOM		
<b>DATE OF REGISTRATION</b>	08/06/2012	
<b>TITLE</b>	CONNECTOR FOR CABLES AND DUCTS	
<b>PRIORITY</b>		
<b>PRIORITY NUMBER</b>	<b>DATE</b>	<b>COUNTRY</b>
001306047-0003	09/12/2011	OHIM

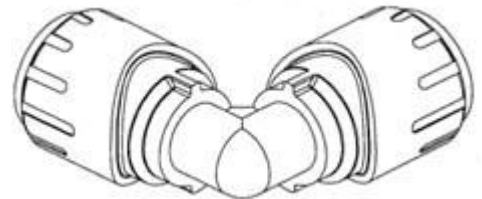

<b>DESIGN NUMBER</b>	248708	
<b>CLASS</b>	14-03	
<b>1)KONINKLIJKE PHILIPS ELECTRONICS N.V., A COMPANY ORGANIZED AND EXISTING UNDER THE LAWS OF THE KINGDOM OF THE NETHERLANDS, RESIDING AT EINDHOVEN, WHOSE POST-OFFICE ADDRESS IS</b> GROENEWOUDSEWEG 1, 5621 BA, EINDHOVEN, THE NETHERLANDS		
<b>DATE OF REGISTRATION</b>	12/10/2012	
<b>TITLE</b>	TELEPHONE	
<b>PRIORITY</b>		
<b>PRIORITY NUMBER</b>	<b>DATE</b>	<b>COUNTRY</b>
002024943-0001	12/04/2012	OHIM

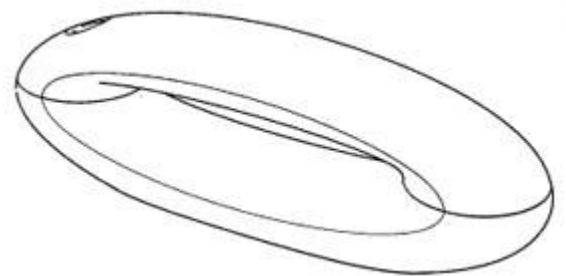

<b>DESIGN NUMBER</b>	250880	
<b>CLASS</b>	12-16	
<b>1)FORD GLOBAL TECHNOLOGIES, LLC A COMPANY ORGANIZED AND EXISTING UNDER THE LAWS OF UNITED STATES OF AMERICA, HAVING ITS OFFICE AT</b> SUITE 800, 330 TOWN CENTER DRIVE, DEARBORN MICHIGAN-48126, UNITED STATES OF AMERICA		
<b>DATE OF REGISTRATION</b>	09/01/2013	
<b>TITLE</b>	VEHICLE REAR VIEW MIRROR	
<b>PRIORITY</b>		
<b>PRIORITY NUMBER</b>	<b>DATE</b>	<b>COUNTRY</b>
402012100596.0	02/08/2012	GERMANY



<b>DESIGN NUMBER</b>	250947	
<b>CLASS</b>	12-16	
<b>1)FORD GLOBAL TECHNOLOGIES, LLC A COMPANY ORGANIZED AND EXISTING UNDER THE LAWS OF UNITED STATES OF AMERICA, HAVING ITS OFFICE AT</b> SUITE 800, 330 TOWN CENTER DRIVE, DEARBORN MICHIGAN-48126, UNITED STATES OF AMERICA		
<b>DATE OF REGISTRATION</b>	10/01/2013	
<b>TITLE</b>	VEHICLE WHEEL RIM	
<b>PRIORITY</b>		
<b>PRIORITY NUMBER</b>	<b>DATE</b>	<b>COUNTRY</b>
402012100596.0	02/08/2012	GERMANY



<b>DESIGN NUMBER</b>	250560	
<b>CLASS</b>	12-16	
<b>1)HONDA MOTOR CO., LTD., A JAPANESE CORPORATION, OF</b> 1-1, MINAMIAOYAMA 2-CHOME, MINATO-KU, TOKYO, JAPAN		
<b>DATE OF REGISTRATION</b>	31/12/2012	
<b>TITLE</b>	FRONT SIDE COWL FOR MOTORCYCLE	
<b>PRIORITY</b>		
<b>PRIORITY NUMBER</b>	<b>DATE</b>	<b>COUNTRY</b>
2012-017029	18/07/2012	JAPAN





<b>DESIGN NUMBER</b>	232668	
<b>CLASS</b>	02-02	
<b>1)MAHOTSAV CREATION PVT. LTD.,</b> "MAHOTSAV HOUSE" NO.6, RATHI PALACE, RING ROAD, SURAT-385002, GUJARAT		
<b>DATE OF REGISTRATION</b>	16/11/2010	
<b>TITLE</b>	SAREE AND BLOUSE SET	
<b>PRIORITY NA</b>		



<b>DESIGN NUMBER</b>	251265	
<b>CLASS</b>	06-01	
<b>1)THE SUPREME INDUSTRIES LTD., (AN INDIAN PUBLIC LIMITED COMPANY), 601, CENTRAL PLAZA, 2/6, SARAT BOSE ROAD, KOLKATA - 700020, WEST BENGAL, INDIA</b>		
<b>DATE OF REGISTRATION</b>	29/01/2013	
<b>TITLE</b>	CHAIR	
<b>PRIORITY NA</b>		

<b>DESIGN NUMBER</b>	249046	
<b>CLASS</b>	08-06	
<b>1)SANDEEPBHAI GIRDHARBHAI RAIYANI (INDIAN NATIONALS) SOLE PROPRIETOR OF RAJ TECHNOCAST (INDIAN PROPRIETORSHIP CONCERN) HAVING PLACE OF BUSINESS AT - 7, PARSANA SOCIETY, 50 FOOT ROAD, NEAR SORATHIYAWADI CIRCLE, RAJKOT-GUJARAT (INDIA)</b>		
<b>DATE OF REGISTRATION</b>	29/10/2012	
<b>TITLE</b>	HANDLE	
<b>PRIORITY NA</b>		

<b>DESIGN NUMBER</b>	249163	
<b>CLASS</b>	26-02	
<b>1)EASY SOLAR SOLUTIONS PVT. LTD., 101, FIRST FLOOR, 65, VIJAY BLOCK, HIMALYA PALACE, (BEHIND ARCHIES GALLERY), VIKAS MARG, LAXMI NAGAR, DELHI-110 092, INDIA, AN INDIAN COMPANY REGISTERED UNDER THE PROVISIONS OF INDIAN COMPANIES ACT, 1956, OF THE ABOVE ADDRESS</b>		
<b>DATE OF REGISTRATION</b>	01/11/2012	
<b>TITLE</b>	LANTERN	
<b>PRIORITY NA</b>		



<b>DESIGN NUMBER</b>	251054	
<b>CLASS</b>	12-11	
<b>1)HERO CYCLES LIMITED,</b> HERO NAGAR, G. T. ROAD, LUDHIANA-141003 (PUNJAB), INDIA, (AN INDIAN COMPANY DULY INCORPORATED UNDER THE PROVISIONS OF INDIAN COMPANIES ACT, 1956)		
<b>DATE OF REGISTRATION</b>	21/01/2013	
<b>TITLE</b>	BICYCLE	
<b>PRIORITY NA</b>		

<b>DESIGN NUMBER</b>	248201	
<b>CLASS</b>	14-03	
<b>1)RESEARCH IN MOTION LIMITED, A CANADIAN CORPORATION</b> OF 295 PHILLIP STREET, WATERLOO, ONTARIO N2L 3W8, CANADA		
<b>DATE OF REGISTRATION</b>	27/09/2012	
<b>TITLE</b>	MOBILE PHONE	
<b>PRIORITY</b>		
<b>PRIORITY NUMBER</b>	<b>DATE</b>	<b>COUNTRY</b>
29/417052	29/03/2012	U.S.A.

<b>DESIGN NUMBER</b>	248268	
<b>CLASS</b>	15-04	
<b>1)JOSEPH VÖGELE AG,</b> OF JOSEPH-VÖGELE-STR.1, 67067 LUDWIGSHAFEN/RHEIN, GERMANY; NATIONALITY: GERMAN		
<b>DATE OF REGISTRATION</b>	28/09/2012	
<b>TITLE</b>	SCREED OF A ROAD MAKING MACHINE	
<b>PRIORITY</b>		
<b>PRIORITY NUMBER</b>	<b>DATE</b>	<b>COUNTRY</b>
001322689	29/03/2012	OHIM

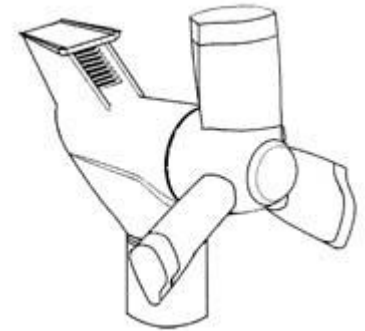
<b>DESIGN NUMBER</b>	246872	
<b>CLASS</b>	09-01	
<b>1)INTERNATIONAL FOODSTUFFS COMPANY (LIMITED LIABILITY COMPANY, UNDER THE LAWS OF UNITED ARAB EMIRATES) HAVING ADDRESS</b> AT POST BOX NO. 4115, SHARJAH, UNITED ARAB EMIRATES		
<b>DATE OF REGISTRATION</b>	01/08/2012	
<b>TITLE</b>	CARBOY	
<b>PRIORITY NA</b>		
<b>DESIGN NUMBER</b>	249421	
<b>CLASS</b>	13-01	
<b>1)YOUWINENERGY GMBH, A COMPANY ORGANIZED AND EXISTING UNDER THE LAWS OF GERMANY, HAVING ITS OFFICE AT</b> RUDOLF-DIESEL-STR. 9, D-26135 OLDENBURG, ALEMANIA, GERMANY		
<b>DATE OF REGISTRATION</b>	09/11/2012	
<b>TITLE</b>	NACELLE OF WIND TURBINE	
<b>PRIORITY</b>		
<b>PRIORITY NUMBER</b>	<b>DATE</b>	<b>COUNTRY</b>
002103267	14/09/2012	OHIM
<b>DESIGN NUMBER</b>	249486	
<b>CLASS</b>	23-01	
<b>1)STRAUSS WATER LTD., OF</b> 49 HASIVIM ST., PETACH TIKVA 49517, ISRAEL; NATIONALITY: ISRAELI		
<b>DATE OF REGISTRATION</b>	15/11/2012	
<b>TITLE</b>	WATER PURIFIER	
<b>PRIORITY</b>		
<b>PRIORITY NUMBER</b>	<b>DATE</b>	<b>COUNTRY</b>
52714	20/05/2012	ISRAEL



<b>DESIGN NUMBER</b>	251745	
<b>CLASS</b>	08-06	
<b>1)PIYUSHBHAI DILIPBHAI DHOLARIYA (ADULT, &amp; INDIAN NATIONAL) PROPRIETOR OF FLOWTECH INDUSTRIES HAVING PLACE OF BUSINESS AT :</b> 7, PARSANA SOCIETY, 50 FOOT ROAD, NEAR SORATHIYAWADI CIRCLE, RAJKOT-GUJARAT (INDIA)		
<b>DATE OF REGISTRATION</b>	19/02/2013	
<b>TITLE</b>	HANDLE	
<b>PRIORITY NA</b>		
<b>DESIGN NUMBER</b>	251753	
<b>CLASS</b>	19-02	
<b>1)KANIN INDIA (REGD), B-XXX-6754, FOCAL POINT, LUDHIANA-141010, PUNJAB, INDIA, AN INDIAN PARTNERSHIP FIRM, WHOSE PARTNERS ARE ARIHANT JAIN, VISHWA JAIN, MS. NEELAM JAIN, MR. AMBRISH JAIN, MR. GAUTAM JAIN, AND MR. AMIT JAIN (ALL INDIAN NATIONALS) HAVING THEIR ADDRESS OF</b> B-XXX-6754, FOCAL POINT, LUDHIANA-141010, PUNJAB INDIA		
<b>DATE OF REGISTRATION</b>	19/02/2013	
<b>TITLE</b>	STAPLER	
<b>PRIORITY NA</b>		
<b>DESIGN NUMBER</b>	251805	
<b>CLASS</b>	09-03	
<b>1)MR. SANTOSH KUMAR., AN INDIAN NATIONAL DIRECTOR OF PROMENS (INDIA) PVT. LTD., A COMPANY INCORPORATED UNDER THE COMPANIES ACT, 1956., HAVING ITS PRINCIPAL PLACE OF BUSINESS AT,</b> 601, VENUS ATLANTIS CORPORATE PARK, PRAHALAD NAGAR, AHMEDABAD-380015. GUJARAT-INDIA		
<b>DATE OF REGISTRATION</b>	21/02/2013	
<b>TITLE</b>	BOX (FREIGHT CONTAINER)	
<b>PRIORITY NA</b>		



<b>DESIGN NUMBER</b>	245804	
<b>CLASS</b>	23-01	
<b>1)JOHN GUEST INTERNATION LIMITED OF</b> HORTON ROAD, WEST DRAYTON, MIDDLESEX UB7 8JL, UNITED KINGDOM		
<b>DATE OF REGISTRATION</b>	08/06/2012	
<b>TITLE</b>	CONNECTOR FOR CABLES AND DUCTS	
<b>PRIORITY</b>		
<b>PRIORITY NUMBER</b>	<b>DATE</b>	<b>COUNTRY</b>
001306039-0002	09/12/2011	OHIM





<b>DESIGN NUMBER</b>	245864	
<b>CLASS</b>	02-01	
<b>1)SUMAN BHARTI,</b> PLOT-510, UDHTOG VIHAR PHASE-5, GURGAON-122016, HARYANA, INDIA, A CITIZEN OF INDIA		
<b>DATE OF REGISTRATION</b>	12/06/2012	
<b>TITLE</b>	CORSET	
<b>PRIORITY NA</b>		







<b>DESIGN NUMBER</b>	248606	
<b>CLASS</b>	24-02	
<b>1)BECTON, DICKINSON AND COMPANY, A CORPORATION</b> <b>ORGANISED UNDER THE LAWS OF THE UNITED STATES OF AMERICA,</b> OF 1 BECTON DRIVE, MC 110, FRANKLIN LAKES, NJ 07417-1880, THE UNITED STATES OF AMERICA		
<b>DATE OF REGISTRATION</b>	12/10/2012	
<b>TITLE</b>	CAP FOR A VESSEL ASSEMBLY	
<b>PRIORITY</b>		
<b>PRIORITY NUMBER</b>	<b>DATE</b>	<b>COUNTRY</b>
29/418,181	12/04/2012	U.S.A.



<b>DESIGN NUMBER</b>	250875		
<b>CLASS</b>	26-06		
<b>1)FORD GLOBAL TECHNOLOGIES, LLC A COMPANY ORGANIZED AND EXISTING UNDER THE LAWS OF UNITED STATES OF AMERICA, HAVING ITS OFFICE AT</b> SUITE 800, 330 TOWN CENTER DRIVE, DEARBORN MICHIGAN-48126, UNITED STATES OF AMERICA			
<b>DATE OF REGISTRATION</b>	09/01/2013		
<b>TITLE</b>	VEHICLE TAILLIGHT		
<b>PRIORITY</b>			
<b>PRIORITY NUMBER</b>	<b>DATE</b>	<b>COUNTRY</b>	
402012100597.9	02/08/2012	GERMANY	
<b>DESIGN NUMBER</b>	250908		
<b>CLASS</b>	08-06		
<b>1)DIPAKBHAI PRADEEPBHAI SOJITRA (INDIAN NATIONAL) PROPRIETOR OF UNITECH INDUSTRIES (INDIAN PROPRIETORSHIP CONCERN) HAVING PLACE OF BUSINESS AT:</b> 3/11, BHAKTINAGAR, STATION PLOT, RAJKOT-360002-GUJARAT (INDIA)			
<b>DATE OF REGISTRATION</b>	10/01/2013		
<b>TITLE</b>	HANDLE		
<b>PRIORITY NA</b>			
<b>DESIGN NUMBER</b>	250942		
<b>CLASS</b>	12-16		
<b>1)FORD GLOBAL TECHNOLOGIES, LLC A COMPANY ORGANIZED AND EXISTING UNDER THE LAWS OF UNITED STATES OF AMERICA, HAVING ITS OFFICE AT</b> SUITE 800, 330 TOWN CENTER DRIVE, DEARBORN MICHIGAN-48126, UNITED STATES OF AMERICA			
<b>DATE OF REGISTRATION</b>	10/01/2013		
<b>TITLE</b>	VEHICLE WHEEL RIM		
<b>PRIORITY</b>			
<b>PRIORITY NUMBER</b>	<b>DATE</b>	<b>COUNTRY</b>	
402012100596.0	02/08/2012	GERMANY	



<b>DESIGN NUMBER</b>	251588	
<b>CLASS</b>	06-01	
<b>1)THE SUPREME INDUSTRIES LTD., (AN INDIAN PUBLIC LIMITED COMPANY),</b> 601, CENTRAL PLAZA, 2/6, SARAT BOSE ROAD, KOLKATA - 700020, WEST BENGAL, INDIA		
<b>DATE OF REGISTRATION</b>	12/02/2013	
<b>TITLE</b>	CHAIR	
<b>PRIORITY NA</b>		
<b>DESIGN NUMBER</b>	250468	
<b>CLASS</b>	06-01	
<b>1)GODREJ &amp; BOYCE MFG. CO. LTD., AN INDIAN COMPANY INCORPORATED UNDER THE COMPANIES ACT 1913, OF</b> GODREJ INTERIO, PLANT 4, PIROJSHANAGER, VIKHROLI (WEST), MUMBAI-400079, INDIA		
<b>DATE OF REGISTRATION</b>	26/12/2012	
<b>TITLE</b>	SOFA	
<b>PRIORITY NA</b>		
<b>DESIGN NUMBER</b>	249647	
<b>CLASS</b>	09-01	
<b>1)LION DATES IMPEX (P) LTD., A PRIVATE LIMITED COMPANY, REGISTERED AS PER INDIAN COMPANIES ACT, HAVING OFFICE</b> AT NO. 40, STRELING ROAD, NUNGAMBAKKAM, CHENNAI-600 034, TAMILNADU, INDIA		
<b>DATE OF REGISTRATION</b>	22/11/2012	
<b>TITLE</b>	BOTTLE	
<b>PRIORITY NA</b>		

<b>DESIGN NUMBER</b>	251289	
<b>CLASS</b>	08-06	
<b>1)JALPESHBHAI S. GOSWAMI AND NILESHBHAI S. GOSWAMI BOTH INDIAN NATIONAL PARTNERS OF RUSHIV TECHNOCAST AN INDIAN PARTNERSHIP FIRM HAVING ITS PRINCIPAL PLACE OF BUSINESS AT</b> 80 FEET ROAD, NEAR ACCURATE WEIGH BRIDGE, NEAR AJI VASAHAT, RAJKOT, GUJARAT - INDIA		
<b>DATE OF REGISTRATION</b>	29/01/2013	
<b>TITLE</b>	HANDLE	
<b>PRIORITY NA</b>		