

**INTRODUCTION**

In view of the recent amendment made in the Designs (Amendment) Rules, 2008 with effect from 17/06/2008, Publication of the matter relating to Designs is being published in the Official Journal of The Patent Office. This Journal is being published on weekly basis on every Friday covering the various proceedings on Designs as required according to the provisions of under Rule 22, 25, 27 and 39 of the Design (Amendment) Rules, 2008. All the enquiries on this Official Journal and other information as required by the public should be addressed to the Controller General of Patents, Designs & Trade Marks. Suggestions and comments are requested from all quarters so that the content can be enriched.

## **COPYRIGHT PUBLICATION**

<b>SL NO</b>	<b>CASE NUMBERS</b>	<b>RENEWED ON</b>
<b>1.</b>	<b>235027</b>	<b>13.08.2013</b>
<b>2.</b>	<b>235028</b>	<b>13.08.2013</b>
<b>3.</b>	<b>245071</b>	<b>30.07.2013</b>
<b>4.</b>	<b>245593</b>	<b>30.07.2013</b>
<b>5.</b>	<b>245756</b>	<b>30.07.2013</b>
<b>6.</b>	<b>246094</b>	<b>30.07.2013</b>
<b>7.</b>	<b>246554</b>	<b>30.07.2013</b>
<b>8.</b>	<b>246750</b>	<b>30.07.2013</b>
<b>9.</b>	<b>246751</b>	<b>30.07.2013</b>
<b>10.</b>	<b>246826</b>	<b>30.07.2013</b>

THE DESIGNS ACT 2000  
SECTION 30  
DESIGN ASSIGNMENT

The Design stands in the name of DINESH PATEL SOLE PROPRIETOR OF E SEALS TECHNOLOGIES registered under the Designs Act, 2000 has been assigned in the Register of Designs in the name as follows:-

<b>Design No.</b>	<b>Class</b>	<b>Name</b>
<b>211638, 211640</b>	<b>09-07</b>	<b>PATEL BROTHERS A PROPRIETORSHIP FIRM OF 266/3, G.I.D.C. PHASE-II, WADHWANCITY-363 035 DIST. SURENDRANAGAR, GUJARAT, INDIAN COMPANY REPRESENTED BY IT'S PROPRIETOR ATULBHAI NARSIBHAI PATEL</b>

THE DESIGNS ACT 2000  
SECTION 30  
DESIGN ASSIGNMENT

The Design stands in the name of ZHUHAI NINESTAR MANAGEMENT CO., LTD. registered under the Designs Act, 2000 has been assigned in the Register of Designs in the name as follows:-

<b>Design No.</b>	<b>Class</b>	<b>Name</b>
<b>228815 228816</b>	<b>14-02</b>	<b>ZHUHAI SEINE TECHNOLOGY LIMITED NO. 63, MINGZHUBEI ROAD, XIANGZHOU DISTRICT, ZHUHAI GUANGDONG, CHINA</b>



## REGISTRATION OF DESIGNS

The following designs have been registered. They are now open for public inspection. In the following each entry the Date of Registration is shown. The Priority Number, Priority Date and Priority Country are also shown

<b>DESIGN NUMBER</b>	212720		 <p style="font-size: small; text-align: center;">PERSPECTIVE VIEW – RIGHT FRONT</p>
<b>CLASS</b>	12-13		
<b>1)MS. JAYANTHI JAYACHNADRA RAO.,</b> 303, 11-C, ANITA NAGAR, LOKHANDWALA TOWNSHIP, AKURLI ROAD, KANDIVALI (EAST) MUMBAI-400 101, MAHARASHTRA STATE (INDIA)			
<b>DATE OF REGISTRATION</b>	28/09/2007		
<b>TITLE</b>	INDUSTRIAL SWEEPING MACHINE		
<b>PRIORITY NA</b>			
<b>DESIGN NUMBER</b>	250300		
<b>CLASS</b>	24-01		
<b>1)GE HEALTHCARE BIO-SCIENCES AB, A SWEDISH COMPANY OF</b> BJÖRKGATAN 30, SE-75184 UPPSALA, SWEDEN			
<b>DATE OF REGISTRATION</b>	19/12/2012		
<b>TITLE</b>	CHROMATOGRAPHY COLUMN		
<b>PRIORITY</b>			
<b>PRIORITY NUMBER</b>	<b>DATE</b>	<b>COUNTRY</b>	
13/528973	21/06/2012	U.S.A.	
<b>DESIGN NUMBER</b>	251293		
<b>CLASS</b>	08-09		
<b>1)RAKESHBHAI VITTHALBHAI BHALARA AN INDIAN NATIONAL SOLE</b> <b>PROPRIETOR OF DIVINE OVERSEAS INDIA AN INDIAN PROPRIETORSHIP</b> <b>FIRM HAVING ITS PRINCIPAL PLACE OF BUSINESS AT</b> PLOT NO. 4, SURVEY NO. 229, OPP. SARDAR CASTING, B/H. PARIN FURNITURE, DHOLRA ROAD, GONDAL HIGHWAY, RAJKOT, GUJARAT-INDIA			
<b>DATE OF REGISTRATION</b>	29/01/2013		
<b>TITLE</b>	GLASS PATCH FITTINGS		
<b>PRIORITY NA</b>			

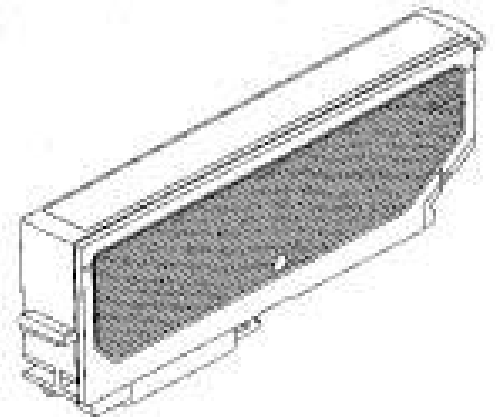
<b>DESIGN NUMBER</b>	251750	
<b>CLASS</b>	08-06	
<b>1)MUKESHBHAI GORDHANBHAI RAKHOLIYA (ADULT AND INDIAN NATIONAL) AND SOLE PROPRIETOR OF RAMESHWAR METAL (INDIAN PROPRIETORSHIP CONCERN) HAVING PLACE OF BUSINESS AT-</b> 4, PARSANA SOCIETY, 50 FEET MAIN ROAD, B/H. 73 NUMBERS SCHOOL, RAJKOT-GUJARAT-(INDIA)		
<b>DATE OF REGISTRATION</b>	19/02/2013	
<b>TITLE</b>	HANDLE	
<b>PRIORITY NA</b>		
<b>DESIGN NUMBER</b>	251868	
<b>CLASS</b>	18-02	
<b>1)SEIKO EPSON CORPORATION, A CORPORATION ORGANIZED AND EXISTING UNDER THE LAWS OF JAPAN,</b> 4-1, NISHISHINJUKU 2-CHOME, SHINJUKU-KU, TOKYO 163-0811 JAPAN		
<b>DATE OF REGISTRATION</b>	26/02/2013	
<b>TITLE</b>	INK CARTRIDGE	
<b>PRIORITY</b>		
<b>PRIORITY NUMBER</b>	<b>DATE</b>	<b>COUNTRY</b>
2012-021045	31/08/2012	JAPAN
<b>PRIORITY NA</b>		
<b>DESIGN NUMBER</b>	252113	
<b>CLASS</b>	12-11	
<b>1)TVS MOTOR COMPANY LIMITED, AN INDIAN COMPANY INCORPORATED UNDER THE COMPANIES ACT, 1956, HAVING ITS REGISTERED OFFICE AT</b> JAYALAKSHMI ESTATES''• , 29 (OLD NO. 8) HADDOWS ROAD, CHENNAI 600006, TAMIL NADU, INDIA		
<b>DATE OF REGISTRATION</b>	06/03/2013	
<b>TITLE</b>	MOTORCYCLE	
<b>PRIORITY NA</b>		

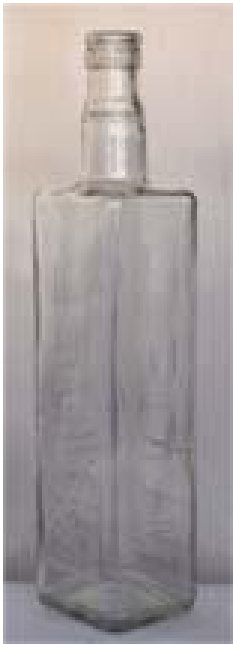

<b>DESIGN NUMBER</b>	252145	
<b>CLASS</b>	11-01	
<b>1)MEHTA FAMILY TRUST TRADING AS MEHTA JEWELLERY, NO.43, CP RAMASWAMY ROAD, ABHIRAMAPURAM, CHENNAI-600018</b>		
<b>DATE OF REGISTRATION</b>	06/03/2013	
<b>TITLE</b>	EARRING	
<b>PRIORITY NA</b>		
<b>DESIGN NUMBER</b>	248488	
<b>CLASS</b>	08-06	
<b>1)MUKESHBHAI GORDHANBHAI RAKHOLIYA (ADULT AND INDIAN NATIONAL) AND SOLE PROPRIETOR OF RAMESHWAR METAL (INDIAN PROPRIETORSHIP CONCERN) HAVING PLACE OF BUSINESS AT-4, PARSANA SOCIETY, 50 FEET MAIN ROAD, B/H. 73 NUMBERS SCHOOL, RAJKOT-GUJARAT-(INDIA)</b>		
<b>DATE OF REGISTRATION</b>	08/10/2012	
<b>TITLE</b>	HANDLE	
<b>PRIORITY NA</b>		
<b>DESIGN NUMBER</b>	250828	
<b>CLASS</b>	08-08	
<b>1)(1)MUKESHBHAI B. SORATHIYA AND (2) JAYSUKHBHAI R. SORATHIYA BOTH INDIAN NATIONAL PARTNER OF SERON STEEL INDUSTRIES AN INDIAN PARTNERSHIP FIRM HAVING ITS PRINCIPAL PLACE OF BUSINESS AT 2/8, SORATHIYAWADI CORNER, 80 FEET ROAD, NEAR SORATHIYAWADI GARDEN, RAJKOT-360003, GUJARAT-INDIA</b>		
<b>DATE OF REGISTRATION</b>	07/01/2013	
<b>TITLE</b>	CURTAIN BRACKET SUPPORT	
<b>PRIORITY NA</b>		

<b>DESIGN NUMBER</b>	250034	
<b>CLASS</b>	09-01	
<b>1)PERNOD RICARD INDIA PVT. LTD., A COMPANY INCORPORATED UNDER THE LAWS OF THE INDIA HAVING ITS REGISTERED OFFICE AT 104, ASHOKA ESTATE, BARAKHAMBA ROAD, NEW DELHI-110001, INDIA</b>		
<b>DATE OF REGISTRATION</b>	10/12/2012	
<b>TITLE</b>	BOTTLE	
<b>PRIORITY NA</b>		

<b>DESIGN NUMBER</b>	241759	
<b>CLASS</b>	14-03	
<b>1)HUAWEI TECHNOLOGIES CO. LTD., HUAWEI ADMINISTRATION BUILDING, BANTIA, LONGGANG DISTRICT, SHENZHEN, GUANGDONG 518129, P.R. CHINA</b>		
<b>DATE OF REGISTRATION</b>	26/12/2011	
<b>TITLE</b>	ENTERPRISE GATEWAY.	
<b>PRIORITY</b>		
<b>PRIORITY NUMBER</b>	<b>DATE</b>	<b>COUNTRY</b>
201130197354.7	24/06/2011	CHINA

<b>DESIGN NUMBER</b>	247839	
<b>CLASS</b>	08-06	
<b>1)SANVI ENTERPRISE, NATIONAL HIGH WAY 8-B, OPP. PARIN FURNITURE, KOTHARIYA SOLVENT AREA, NEAR DHOKIYA MOTORS, KOTHARIYA, DIST. : RAJKOT-360004, GUJARAT, INDIA, INDIAN COMPANY</b>		
<b>DATE OF REGISTRATION</b>	12/09/2012	
<b>TITLE</b>	DOOR HANDLE	
<b>PRIORITY NA</b>		

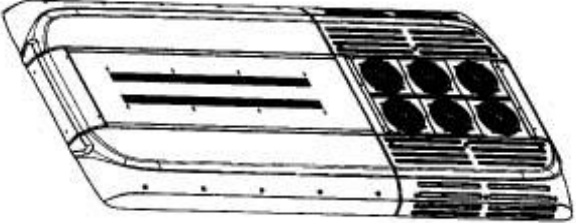
<b>DESIGN NUMBER</b>	247923	
<b>CLASS</b>	23-04	
<b>1)KONVEKTA AG, A GERMAN COMPANY</b> OF AM NORDBAHNHOF 5, 34613 SCHWALMSTADT, GERMANY		
<b>DATE OF REGISTRATION</b>	14/09/2012	
<b>TITLE</b>	AIR CONDITIONING APPARATUS	
<b>PRIORITY NA</b>		

<b>DESIGN NUMBER</b>	248073	
<b>CLASS</b>	15-06	
<b>1)PICANOL N.V.</b> OF STEVERLYNCKLAAN 15, B-8900 IEPEL BELGIUM, BELGIAN COMPANY		
<b>DATE OF REGISTRATION</b>	21/09/2012	
<b>TITLE</b>	WEAVING MACHINE	
<b>PRIORITY</b>		
<b>PRIORITY NUMBER</b>	<b>DATE</b>	<b>COUNTRY</b>
001320345	30/03/2012	OHIM

<b>DESIGN NUMBER</b>	251059	
<b>CLASS</b>	12-11	
<b>1)HERO CYCLES LIMITED,</b> HERO NAGAR, G. T. ROAD, LUDHIANA-141003 (PUNJAB), INDIA, (AN INDIAN COMPANY DULY INCORPORATED UNDER THE PROVISIONS OF INDIAN COMPANIES ACT, 1956)		
<b>DATE OF REGISTRATION</b>	21/01/2013	
<b>TITLE</b>	BICYCLE	
<b>PRIORITY NA</b>		



<b>DESIGN NUMBER</b>	251087
<b>CLASS</b>	15-03
<b>1)GORDHANBHAI JIVABHAI BAMBHANIA AN INDIAN NATIONAL SOLE PROPRIETOR OF BHARAT ENGINEERING WORKS HAVING ITS PRINCIPAL PLACE OF BUSINESS AT</b> ATKOT ROAD, GEETA NAGAR, JASDAN 360050 DISTRICT RAJKOT, GUJARAT STATE, INDIA	
<b>DATE OF REGISTRATION</b>	22/01/2013
<b>TITLE</b>	CHAFF CUTTING MACHINE
<b>PRIORITY NA</b>	





<b>DESIGN NUMBER</b>	251644
<b>CLASS</b>	07-01
<b>1)MA DESIGN INDIA PRIVATE LIMITED, A COMPANY INCORPORATED IN INDIA HAVING ITS PRINCIPAL PLACE OF BUSINESS AT</b> A-41, SECTOR-80, PHASE-II, NOIDA-201305, U.P. INDIA	
<b>DATE OF REGISTRATION</b>	14/02/2013
<b>TITLE</b>	DISH
<b>PRIORITY NA</b>	



<b>DESIGN NUMBER</b>	251653
<b>CLASS</b>	11-02
<b>1)MA DESIGN INDIA PRIVATE LIMITED, A COMPANY INCORPORATED IN INDIA HAVING ITS PRINCIPAL PLACE OF BUSINESS AT</b> A-41, SECTOR-80, PHASE-II, NOIDA-201305, U.P. INDIA	
<b>DATE OF REGISTRATION</b>	14/02/2013
<b>TITLE</b>	TABLE CENTREPIECE
<b>PRIORITY NA</b>	



<b>DESIGN NUMBER</b>	251661	
<b>CLASS</b>	11-02	
<b>1)MA DESIGN INDIA PRIVATE LIMITED, A COMPANY INCORPORATED IN INDIA HAVING ITS PRINCIPAL PLACE OF BUSINESS AT A-41, SECTOR-80, PHASE-II, NOIDA-201305, U.P. INDIA</b>		
<b>DATE OF REGISTRATION</b>	14/02/2013	
<b>TITLE</b>	WALL ORNAMENT	
<b>PRIORITY NA</b>		
<b>DESIGN NUMBER</b>	251704	
<b>CLASS</b>	31-00	
<b>1)MR. JAYNARAYAN AGARWAL, 17, CAMA INDL ESTATE, WALBHAT ROAD., GOREGAON (E), MUMBAI 400063 OF SHRI. JAYNARAYAN AGARWAL</b>		
<b>DATE OF REGISTRATION</b>	18/02/2013	
<b>TITLE</b>	MIXER & GRINDER	
<b>PRIORITY NA</b>		
<b>DESIGN NUMBER</b>	251294	
<b>CLASS</b>	08-09	
<b>1)RAKESHBHAI VITTHALBHAI BHALARA AN INDIAN NATIONAL SOLE PROPRIETOR OF DIVINE OVERSEAS INDIA AN INDIAN PROPRIETORSHIP FIRM HAVING ITS PRINCIPAL PLACE OF BUSINESS AT PLOT NO. 4, SURVEY NO. 229, OPP. SARDAR CASTING, B/H. PARIN FURNITURE, DHOLRA ROAD, GONDAL HIGHWAY, RAJKOT, GUJARAT-INDIA</b>		
<b>DATE OF REGISTRATION</b>	29/01/2013	
<b>TITLE</b>	GLASS PATCH FITTINGS	
<b>PRIORITY NA</b>		

<b>DESIGN NUMBER</b>	240892	
<b>CLASS</b>	02-04	
<b>1)M/S JIYA ENTERPRISES</b> 31/142, RAWLI, AGRA, UTTAR PRADESH (INDIA)		
<b>DATE OF REGISTRATION</b>	23/11/2011	
<b>TITLE</b>	SOLE FOR FOOTWEAR	
<b>PRIORITY NA</b>		
<b>DESIGN NUMBER</b>	247588	
<b>CLASS</b>	06-03	
<b>1)RABIRUN VINIMAY PVT. LTD., PLOT F3, SECTOR F, VIDYASAGAR INDUSTRIAL PARK, (KHARAGPUR-WBIDC), VILL./MOUZA-JAPHALA, P.O.-JAKPUR,</b> P.S.- KHARAGPUR (L), DIST.- PASCHIM MEDINIPUR-721301, WEST BENGAL, INDIA		
<b>DATE OF REGISTRATION</b>	03/09/2012	
<b>TITLE</b>	KITCHEN TABLE	
<b>PRIORITY NA</b>		
<b>DESIGN NUMBER</b>	249718	
<b>CLASS</b>	09-07	
<b>1)MR. RACHIT ATREY S/O. SH. V. K. ATREY,</b> HOUSE NO. 181, AVAS VIKAS COLONY, ROORKEE PIN CODE :247667, DISTT HARIDWAR, UTTRAKHAND, NATIONALITY (INDIAN)		
<b>DATE OF REGISTRATION</b>	27/11/2012	
<b>TITLE</b>	COVER OF BOTTLE CAP	
<b>PRIORITY NA</b>		

<b>DESIGN NUMBER</b>	249838	
<b>CLASS</b>	06-04	
<b>1)(1) LAVJIBHAI POPATBHAI SHINGALA (2) BHAVESHBHAI LAVJIBHAI SHINGALA AN INDIAN NATIONAL AND PARTNERS OF SHIVAM STEEL FURNITURE (A PARTNERSHIP FIRM) HAVING HIS PLACE OF BUSINESS AT KOTHARIYA RING ROAD, B/H. MURLIDHAR WAY-BRIDGE, MARUTI INDUSTRIAL AREA, STREET NO. 2, RAJKOT-360003 GUJARAT (INDIA)</b>		
<b>DATE OF REGISTRATION</b>	03/12/2012	
<b>TITLE</b>	CUPBOARD	
<b>PRIORITY NA</b>		
<b>DESIGN NUMBER</b>	250728	
<b>CLASS</b>	31-00	
<b>1)BAJAJ ELECTRICALS LIMITED, A COMPANY REGISTERED IN INDIA, HAVING ITS REGISTERED OFFICE AT, 45/47, VEER NARIMAN ROAD, MUMBAI 400023, STATE OF MAHARASHTRA, INDIA, OF ABOVE ADDRESS 45/47, VEER NARIMAN ROAD, MUMBAI 400023, STATE OF MAHARASHTRA, INDIA, OF ABOVE ADDRESS</b>		
<b>DATE OF REGISTRATION</b>	04/01/2013	
<b>TITLE</b>	BASE OF MIXER GRINDER	
<b>PRIORITY NA</b>		
<b>DESIGN NUMBER</b>	251722	
<b>CLASS</b>	08-07	
<b>1)DEEPAK JAGGANATH KOLI (AN INDIAN NATIONAL) AT OM REGENCY'', B-WING, ROOM NO. 603., 6TH FLR. MANVELPADA TALAV GARDEN, VIRAR EAST THANE-401303. MAHARASHTRA INDIA</b>		
<b>DATE OF REGISTRATION</b>	18/02/2013	
<b>TITLE</b>	SEAL	
<b>PRIORITY NA</b>		

<b>DESIGN NUMBER</b>	251752
<b>CLASS</b>	08-06
<b>1)MUKESHBHAI GORDHANBHAI RAKHOLIYA (ADULT AND INDIAN NATIONAL) AND SOLE PROPRIETOR OF RAMESHWAR METAL (INDIAN PROPRIETORSHIP CONCERN) HAVING PLACE OF BUSINESS AT- 4, PARSANA SOCIETY, 50 FEET MAIN ROAD, B/H. 73 NUMBERS SCHOOL, RAJKOT-GUJARAT-(INDIA)</b>	
<b>DATE OF REGISTRATION</b>	19/02/2013
<b>TITLE</b>	HANDLE
<b>PRIORITY NA</b>	



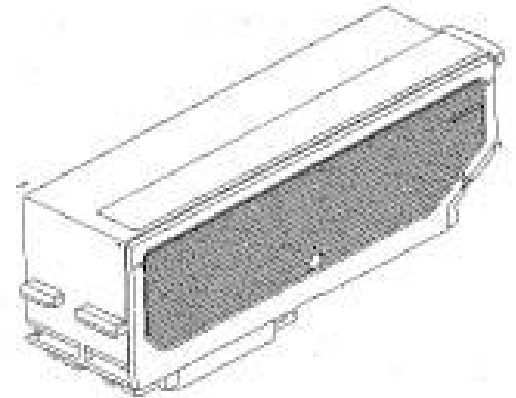

<b>DESIGN NUMBER</b>	251869	
<b>CLASS</b>	18-02	
<b>1)SEIKO EPSON CORPORATION, A CORPORATION ORGANIZED AND EXISTING UNDER THE LAWS OF JAPAN, 4-1, NISHISHINJUKU 2-CHOME, SHINJUKU-KU, TOKYO 163-0811 JAPAN</b>		
<b>DATE OF REGISTRATION</b>	26/02/2013	
<b>TITLE</b>	INK CARTRIDGE	
<b>PRIORITY</b>		
<b>PRIORITY NUMBER</b>	<b>DATE</b>	<b>COUNTRY</b>
2012-021046	31/08/2012	JAPAN



<b>DESIGN NUMBER</b>	251884
<b>CLASS</b>	13-03
<b>1)LARSEN &amp; TOUBRO LIMITED, AN INDIAN COMPANY INCORPORATED UNDER THE COMPANIES ACT, 1956 OF L &amp; T HOUSE, BALLARD ESTATE, MUMBAI 400001, STATE OF MAHARASHTRA, INDIA</b>	
<b>DATE OF REGISTRATION</b>	26/02/2013
<b>TITLE</b>	MOULDED CASE CIRCUIT BREAKER
<b>PRIORITY NA</b>	

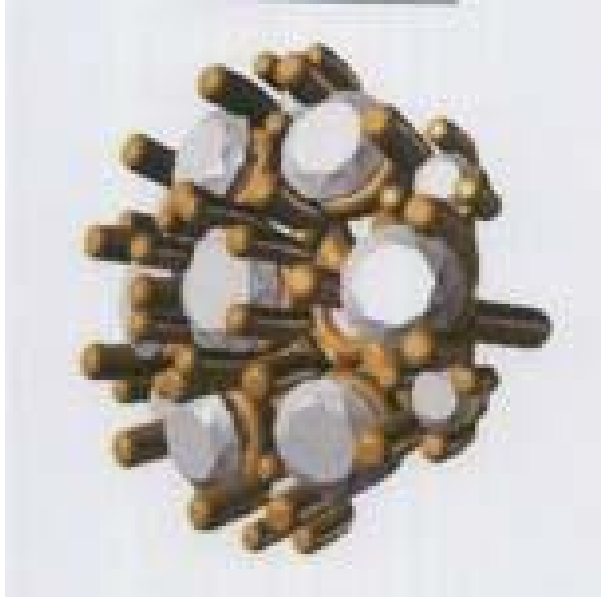

<b>DESIGN NUMBER</b>	252114	
<b>CLASS</b>	12-11	
<b>1)TVS MOTOR COMPANY LIMITED, AN INDIAN COMPANY INCORPORATED UNDER THE COMPANIES ACT, 1956, HAVING ITS REGISTERED OFFICE AT JAYALAKSHMI ESTATES'', 29 (OLD NO. 8) HADDOWS ROAD, CHENNAI 600 006, TAMIL NADU, INDIA</b>		
<b>DATE OF REGISTRATION</b>	06/03/2013	
<b>TITLE</b>	SCOOTER	
<b>PRIORITY NA</b>		
<b>DESIGN NUMBER</b>	252146	
<b>CLASS</b>	11-01	
<b>1)MEHTA FAMILY TRUST TRADING AS MEHTA JEWELLERY, NO.43, CP RAMASWAMY ROAD, ABHIRAMAPURAM, CHENNAI-600018</b>		
<b>DATE OF REGISTRATION</b>	06/03/2013	
<b>TITLE</b>	EARRING	
<b>PRIORITY NA</b>		
<b>DESIGN NUMBER</b>	248632	
<b>CLASS</b>	08-06	
<b>1)DILIP CHAUHAN S/O LATE SHRI OM PRAKASH SINGH, C-4, PROFESSOR COLONY, RAMGHAT ROAD, ALIGARH-202001 (U.P.) (INDIA) WHOSE PROPRIETOR IS DILIP CHAUHAN AN INDIAN OF THE ABOVE ADDRESS</b>		
<b>DATE OF REGISTRATION</b>	08/10/2012	
<b>TITLE</b>	ALDROP	
<b>PRIORITY NA</b>		

<b>DESIGN NUMBER</b>	250829	
<b>CLASS</b>	08-08	
<b>1)(1)MUKESHBHAI B. SORATHIYA AND (2) JAYSUKHBHAI R. SORATHIYA BOTH INDIAN NATIONAL PARTNER OF SERON STEEL INDUSTRIES AN INDIAN PARTNERSHIP FIRM HAVING ITS PRINCIPAL PLACE OF BUSINESS AT</b> 2/8, SORATHIYAWADI CORNER, 80 FEET ROAD, NEAR SORATHIYAWADI GARDEN, RAJKOT-360003, GUJARAT-INDIA		
<b>DATE OF REGISTRATION</b>	07/01/2013	
<b>TITLE</b>	CURTAIN BRACKET SUPPORT	
<b>PRIORITY NA</b>		
<b>DESIGN NUMBER</b>	250868	
<b>CLASS</b>	09-03	
<b>1)VIDYA PETROLEUM (I) PRIVATE LIMITED, A COMPANY INCORPORATED UNDER THE COMPANIES ACT, 1956 WHOSE ADDRESS IS</b> 205/206, POPATLAL CHAMBERS 4TH CROSS CLIVE ROAD, DANA BUNDER, MASJID (EAST), MUMBAI 400009, MAHARASHTRA, INDIA, INDIAN NATIONAL		
<b>DATE OF REGISTRATION</b>	08/01/2013	
<b>TITLE</b>	CONTAINER	
<b>PRIORITY NA</b>		
<b>DESIGN NUMBER</b>	250912	
<b>CLASS</b>	15-09	
<b>1)M/S FUHRER MACHINES INC. IIND STREET, KALSI NAGAR, NEAR DADA MOTOR, G. T. ROAD, LUDHIANA-141003 (PUNJAB) INDIA</b> AN INDIAN PROPRIETORSHIP FIRM WHOSE PROPRIETOR IS :- AMRITPAL SINGH BEING INDIAN NATIONALS OF THE ABOVE ADDRESS		
<b>DATE OF REGISTRATION</b>	10/01/2013	
<b>TITLE</b>	TURNING MACHINE FOR METALS	
<b>PRIORITY NA</b>		



<b>DESIGN NUMBER</b>	251008	
<b>CLASS</b>	14-03	
<b>1)PLANTRONICS INC., A DELAWARE CORPORATION HAVING A PLACE OF BUSINESS AT</b> 345 ENCINAL STREET, SANTA CRUZ, CALIFORNIA 95060, UNITED STATES OF AMERICA		
<b>DATE OF REGISTRATION</b>	17/01/2013	
<b>TITLE</b>	COMMUNICATIONS HEADSET	
<b>PRIORITY</b>		
<b>PRIORITY NUMBER</b>	<b>DATE</b>	<b>COUNTRY</b>
29/427,487	18/07/2012	U.S.A.



<b>DESIGN NUMBER</b>	206572	
<b>CLASS</b>	09-01	
<b>1)SALVADOR FASHION PVT LTD.,</b> 1956 BARODA-JAMBUSAR N. HIGH WAY ROAD, AT & PO. DABHASA, TA. PADRA-391440, DIST. BARODA (GUJARAT), INDIA		
<b>DATE OF REGISTRATION</b>	17/10/2006	
<b>TITLE</b>	CONTAINER	
<b>PRIORITY NA</b>		





<b>DESIGN NUMBER</b>	250016	
<b>CLASS</b>	03-01	
<b>1)PAHWA INTERNATIONAL, AN INDIAN PARTNERSHIP FIRM WHOSE PARTNERS ARE SURINDER SINGH PAHWA, RAWEL KAUR PHAWA, NIRVER SINGH PAHWA AND FATEH SINGH PAHWA AL INDIAN NATIONALS, HAVING ITS ADDRESS AT</b> F-29, OKHLA INDUSTRIAL AREA, PHASE-I, NEW DELHI-110020, INDIA		
<b>DATE OF REGISTRATION</b>	07/12/2012	
<b>TITLE</b>	PURSE	
<b>PRIORITY NA</b>		





<b>DESIGN NUMBER</b>	251060	
<b>CLASS</b>	12-11	
<b>1)HERO CYCLES LIMITED,</b> HERO NAGAR, G. T. ROAD, LUDHIANA-141003 (PUNJAB), INDIA, (AN INDIAN COMPANY DULY INCORPORATED UNDER THE PROVISIONS OF INDIAN COMPANIES ACT, 1956)		
<b>DATE OF REGISTRATION</b>	21/01/2013	
<b>TITLE</b>	BICYCLE	
<b>PRIORITY NA</b>		

<b>DESIGN NUMBER</b>	251088	
<b>CLASS</b>	15-03	
<b>1)GORDHANBHAI JIVABHAI BAMBHANIA AN INDIAN NATIONAL SOLE PROPRIETOR OF BHARAT ENGINEERING WORKS HAVING ITS PRINCIPAL PLACE OF BUSINESS AT ATKOT ROAD, GEETA NAGAR, JASDAN 360050 DISTRICT RAJKOT, GUJARAT STATE, INDIA</b>		
<b>DATE OF REGISTRATION</b>	22/01/2013	
<b>TITLE</b>	SHREDDER CUTTING MACHINE	
<b>PRIORITY NA</b>		

<b>DESIGN NUMBER</b>	251646	
<b>CLASS</b>	11-02	
<b>1)MA DESIGN INDIA PRIVATE LIMITED, A COMPANY INCORPORATED IN INDIA HAVING ITS PRINCIPAL PLACE OF BUSINESS AT A-41, SECTOR-80, PHASE-II, NOIDA-201305, U.P. INDIA</b>		
<b>DATE OF REGISTRATION</b>	14/02/2013	
<b>TITLE</b>	BOX (FOR JEWELLERY)	
<b>PRIORITY NA</b>		

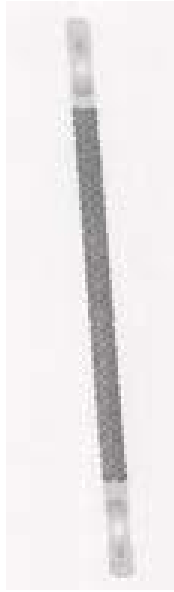
<b>DESIGN NUMBER</b>	251654		
<b>CLASS</b>	07-01		
<b>1)MA DESIGN INDIA PRIVATE LIMITED, A COMPANY INCORPORATED IN INDIA HAVING ITS PRINCIPAL PLACE OF BUSINESS AT</b> A-41, SECTOR-80, PHASE-II, NOIDA-201305, U.P. INDIA			
<b>DATE OF REGISTRATION</b>	14/02/2013		
<b>TITLE</b>	PLATTER		
<b>PRIORITY NA</b>			
<b>DESIGN NUMBER</b>	251662		
<b>CLASS</b>	11-02		
<b>1)MA DESIGN INDIA PRIVATE LIMITED, A COMPANY INCORPORATED IN INDIA HAVING ITS PRINCIPAL PLACE OF BUSINESS AT</b> A-41, SECTOR-80, PHASE-II, NOIDA-201305, U.P. INDIA			
<b>DATE OF REGISTRATION</b>	14/02/2013		
<b>TITLE</b>	WALL ORNAMENT		
<b>PRIORITY NA</b>			
<b>DESIGN NUMBER</b>	242648		
<b>CLASS</b>	07-06		
<b>1)SILMAN INVEST &amp; TRADE LTD.</b> SEYCHELLES, OLIVIER MARADAN BUILDING, OLIVIER MARADAN STREET SUITE 2, VICTORIA, MAHE SEYCHELLES			
<b>DATE OF REGISTRATION</b>	27/01/2012		
<b>TITLE</b>	DRINKING STRAW		
<b>PRIORITY</b>			
<b>PRIORITY NUMBER</b>	<b>DATE</b>	<b>COUNTRY</b>	
001897190-0002	27/07/2011	OHIM	

<b>DESIGN NUMBER</b>	251238	
<b>CLASS</b>	14-99	
<b>1) LG ELECTRONICS INC.,</b> 20 YEOUIDO-DONG YEONGDEUNGPO - GU SEOUL, 150-721 REPUBLIC OF KOREA, A CORPORATION INCORPORATED UNDER THE LAWS OF THE REPUBLIC OF KOREA		
<b>DATE OF REGISTRATION</b>	28/01/2013	
<b>TITLE</b>	STAND FOR TV RECEIVER	
<b>PRIORITY</b>		
<b>PRIORITY NUMBER</b>	<b>DATE</b>	<b>COUNTRY</b>
30-2012-0039807	20/08/2012	REPUBLIC OF KOREA

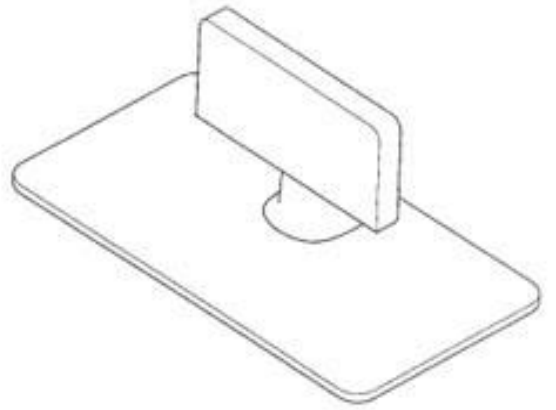

<b>DESIGN NUMBER</b>	251291	
<b>CLASS</b>	08-09	
<b>1) RAKESHBHAI VITTHALBHAI BHALARA AN INDIAN NATIONAL</b> <b>SOLE PROPRIETOR OF DIVINE OVERSEAS INDIA AN INDIAN</b> <b>PROPRIETORSHIP FIRM HAVING ITS PRINCIPAL PLACE OF</b> <b>BUSINESS AT</b> PLOT NO. 4, SURVEY NO. 229, OPP. SARDAR CASTING, B/H. PARIN FURNITURE, DHOLRA ROAD, GONDAL HIGHWAY, RAJKOT, GUJARAT- INDIA		
<b>DATE OF REGISTRATION</b>	29/01/2013	
<b>TITLE</b>	GLASS PATCH FITTINGS	
<b>PRIORITY NA</b>		



<b>DESIGN NUMBER</b>	249669	
<b>CLASS</b>	07-02	
<b>1) 1) SUMERCHAND R. JAIN 2) BHUPENDRA PALRECHA AND 3)</b> <b>JAICHANDRA F. BAFNA, PARTNERS- INDIAN NATIONAL,</b> <b>TRADING AS JAYCO PLASTICS, A REGISTERED PARTNERSHIP</b> <b>FIRM IN INDIA, HAVING ITS REGISTERED OFFICE AT</b> NO. 6-9, GEETA INDUSTRIAL ESTATE NO. 3, SATIVALI ROAD, SATIVALI, VASAI (EAST), THANE-401202, STATE OF MAHARASHTRA, INDIA, OF ABOVE ADDRESS		
<b>DATE OF REGISTRATION</b>	23/11/2012	
<b>TITLE</b>	CASSEROLE	
<b>PRIORITY NA</b>		



<b>DESIGN NUMBER</b>	249864	
<b>CLASS</b>	08-03	
<b>1)AMITBHAI RAMESHBHAI PITRODA AN INDIAN NATIONAL SOLE PROPRIETOR OF MILAN AGREE INDUSTRIES AN INDIAN PROPRIETORSHIP FIRM HAVING ITS PRINCIPAL PLACE OF BUSINESS AT</b> MAVDI BYPASS ROAD, B/H. PATEL COMPLEX, RAJKOT (MAVDI)-360004, GUJARAT-INDIA		
<b>DATE OF REGISTRATION</b>	03/12/2012	
<b>TITLE</b>	PLANT CUTTER	
<b>PRIORITY NA</b>		
<b>DESIGN NUMBER</b>	250725	
<b>CLASS</b>	12-16	
<b>1)ANJU SACHDEVA, AN INDIAN NATIONAL, TRADING AS M/S. SHREE GANESH ENTERPRISES,</b> 65, PART-2, GUJRAWALAN TOWN, NEW DELHI-110009		
<b>DATE OF REGISTRATION</b>	04/01/2013	
<b>TITLE</b>	LUGGAGE BOX FOR TWO WHEELERS	
<b>PRIORITY NA</b>		
<b>DESIGN NUMBER</b>	251749	
<b>CLASS</b>	08-06	
<b>1)MUKESHBHAI GORDHANBHAI RAKHOLIYA (ADULT AND INDIAN NATIONAL) AND SOLE PROPRIETOR OF RAMESHWAR METAL (INDIAN PROPRIETORSHIP CONCERN) HAVING PLACE OF BUSINESS AT-</b> 4, PARSANA SOCIETY, 50 FEET MAIN ROAD, B/H. 73 NUMBERS SCHOOL, RAJKOT-GUJARAT-(INDIA)		
<b>DATE OF REGISTRATION</b>	19/02/2013	
<b>TITLE</b>	HANDLE	
<b>PRIORITY NA</b>		

<b>DESIGN NUMBER</b>	251795
<b>CLASS</b>	24-04
<b>1)NAVCHETAN ORTHOPAEDIC APPLIANCES., (AN INDIAN SOLE PROPRIETORSHIP CONCERN), HAVING OFFICE AT OPP. S. T. DEPOT, JAMNAGAR-361005 (GUJARAT)</b> WHOSE PROPRIETOR IS AMRUTLAL DEVSHIBHAI CHUDASAMA. (INDIAN NATIONAL) OF ABOVE ADDRESS	
<b>DATE OF REGISTRATION</b>	20/02/2013
<b>TITLE</b>	ORTHOPEDIC SUPPORT



**PRIORITY NA**

<b>DESIGN NUMBER</b>	251841
<b>CLASS</b>	10-04
<b>1)METTLER-TOLEDO AG, A CORPORATION ORGANIZED AND EXISTING UNDER THE LAWS OF SWITZERLAND, OF IM LANGACHER 44, CH-8606 GREIFENSEE, SWITZERLAND</b>	
<b>DATE OF REGISTRATION</b>	22/02/2013
<b>TITLE</b>	MEASURING INSTRUMENT

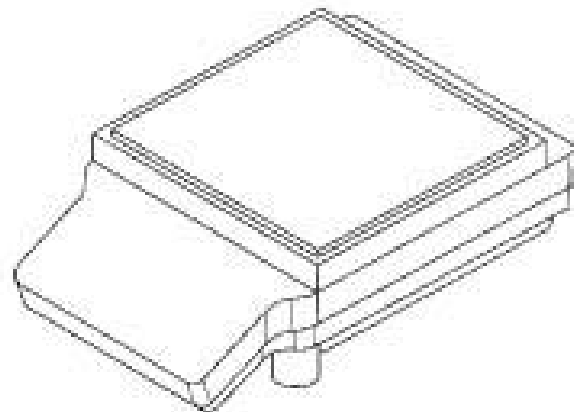

**PRIORITY**

PRIORITY NUMBER	DATE	COUNTRY
002092007	24/08/2012	OHIM

<b>DESIGN NUMBER</b>	251867
<b>CLASS</b>	17-03
<b>1)AJAY SHARMA, RIKHIRAM MUSICAL INSTRUMENT MFG. CO. (INDIA),</b> 8 A, MARINA ARCADE, G-BLOCK, CONNAUGHT CIRIUS, NEW DELHI-110001. (INDIA) AS INDIAN NATIONAL	
<b>DATE OF REGISTRATION</b>	26/02/2013
<b>TITLE</b>	ELECTRIC SITAR



**PRIORITY NA**

<b>DESIGN NUMBER</b>	252112	
<b>CLASS</b>	12-11	
<b>1)TVS MOTOR COMPANY LIMITED, AN INDIAN COMPANY INCORPORATED UNDER THE COMPANIES ACT, 1956, HAVING ITS REGISTERED OFFICE AT JAYALAKSHMI ESTATES''• , 29 (OLD NO. 8) HADDOWS ROAD, CHENNAI 600006, TAMIL NADU, INDIA</b>		
<b>DATE OF REGISTRATION</b>	06/03/2013	
<b>TITLE</b>	MOTORCYCLE	
<b>PRIORITY NA</b>		

<b>DESIGN NUMBER</b>	252144	
<b>CLASS</b>	11-01	
<b>1)MEHTA FAMILY TRUST TRADING AS MEHTA JEWELLERY, NO.43, CP RAMASWAMY ROAD, ABHIRAMAPURAM, CHENNAI-600018</b>		
<b>DATE OF REGISTRATION</b>	06/03/2013	
<b>TITLE</b>	EARRING	
<b>PRIORITY NA</b>		

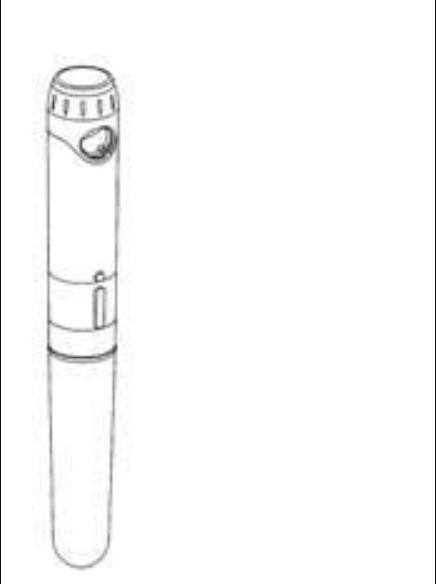
<b>DESIGN NUMBER</b>	248617		
<b>CLASS</b>	24-02		
<b>1)BECTON, DICKINSON AND COMPANY, A COMPANY INCORPORATED UNDER THE LAWS OF THE UNITED STATES OF AMERICA, OF 1 BECTON DRIVE, FRANKLIN LAKES, NJ 07417-1880, THE UNITED STATES OF AMERICA</b>			
<b>DATE OF REGISTRATION</b>	12/10/2012		
<b>TITLE</b>	SELF-INJECTION DEVICE		
<b>PRIORITY</b>			
<b>PRIORITY NUMBER</b>	<b>DATE</b>		<b>COUNTRY</b>
29/418,251	13/04/2012		U.S.A.

<b>DESIGN NUMBER</b>	250824	
<b>CLASS</b>	08-06	
<b>1)(1) PARESHBHAI V. BHALIYA (2) CHANDRIKABEN P. BHALIYA (3) RAJESH O. KOTADIA (4) GHANSHYAM O. KOTADIA ALL INDIAN NATIONAL PARTNERS OF MARUTI METALS AN INDIAN PARTNERSHIP FIRM HAVING ITS PRINCIPAL PLACE OF BUSINESS AT</b> SOMNATH ESTATE, SHOP NO. 3, NEAR DWARKADHISH ESTATE, VIRANI AGHAT, DHEBAR ROAD(SOUTH), RAJKOT-2, GUJARAT-INDIA		
<b>DATE OF REGISTRATION</b>	07/01/2013	
<b>TITLE</b>	HANDLE	
<b>PRIORITY NA</b>		

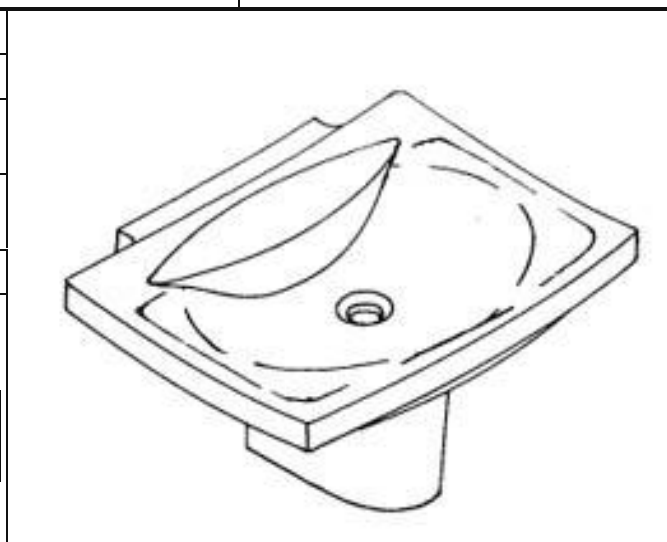

<b>DESIGN NUMBER</b>	193287	
<b>CLASS</b>	23-02	
<b>1) KOHLER FRANCE SAS</b> 60 RUE DE TURENNE, CEDEX 03, 75139, PARIS, FRANCE		
<b>DATE OF REGISTRATION</b>	21/03/2003	
<b>TITLE</b>	LAVATORY	
<b>PRIORITY</b>		
<b>PRIORITY NUMBER</b>	<b>DATE</b>	<b>COUNTRY</b>
29/178,210	21/03/2003	U.S.A.





<b>DESIGN NUMBER</b>	250012	
<b>CLASS</b>	03-01	
<b>1) PAHWA INTERNATIONAL, AN INDIAN PARTNERSHIP FIRM WHOSE PARTNERS ARE SURINDER SINGH PAHWA, RAWEL KAUR PHAWA, NIRVER SINGH PAHWA AND FATEH SINGH PAHWA AL INDIAN NATIONALS, HAVING ITS ADDRESS AT</b> F-29, OKHLA INDUSTRIAL AREA, PHASE-I, NEW DELHI-110020, INDIA		
<b>DATE OF REGISTRATION</b>	07/12/2012	
<b>TITLE</b>	PURSE	
<b>PRIORITY NA</b>		







<b>DESIGN NUMBER</b>	251058	
<b>CLASS</b>	12-11	
<b>1)HERO CYCLES LIMITED,</b> HERO NAGAR, G. T. ROAD, LUDHIANA-141003 (PUNJAB), INDIA, (AN INDIAN COMPANY DULY INCORPORATED UNDER THE PROVISIONS OF INDIAN COMPANIES ACT, 1956)		
<b>DATE OF REGISTRATION</b>	21/01/2013	
<b>TITLE</b>	BICYCLE	
<b>PRIORITY NA</b>		
<b>DESIGN NUMBER</b>	251184	
<b>CLASS</b>	14-03	
<b>1)M/S. SUNRISE EMBEDDED SOLUTIONS PVT. LTD. (A COMPANY DULY INCORPORATED UNDER COMPANIES ACT, 1956),</b> B-30, II FLOOR, RAM NAGAR, OM VIHAR, UTTAM NAGAR, NEW DELHI.		
<b>DATE OF REGISTRATION</b>	24/01/2013	
<b>TITLE</b>	WIRELESS REMOTE CONTROL	
<b>PRIORITY NA</b>		
<b>DESIGN NUMBER</b>	199628	
<b>CLASS</b>	11-01	
<b>1)MRS. PUNITA TRRIKHA</b> S-69, GREATER KAILASH-I, NEW DELHI, 110048, INDIA		
<b>DATE OF REGISTRATION</b>	27/05/2005	
<b>TITLE</b>	ORNAMENT SET	
<b>PRIORITY NA</b>		





<b>DESIGN NUMBER</b>	251643	
<b>CLASS</b>	07-01	
<b>1)MA DESIGN INDIA PRIVATE LIMITED, A COMPANY INCORPORATED IN INDIA HAVING ITS PRINCIPAL PLACE OF BUSINESS AT A-41, SECTOR-80, PHASE-II, NOIDA-201305, U.P. INDIA</b>		
<b>DATE OF REGISTRATION</b>	14/02/2013	
<b>TITLE</b>	DISH	
<b>PRIORITY NA</b>		
<b>DESIGN NUMBER</b>	251652	
<b>CLASS</b>	07-03	
<b>1)MA DESIGN INDIA PRIVATE LIMITED, A COMPANY INCORPORATED IN INDIA HAVING ITS PRINCIPAL PLACE OF BUSINESS AT A-41, SECTOR-80, PHASE-II, NOIDA-201305, U.P. INDIA</b>		
<b>DATE OF REGISTRATION</b>	14/02/2013	
<b>TITLE</b>	SPOON	
<b>PRIORITY NA</b>		
<b>DESIGN NUMBER</b>	251660	
<b>CLASS</b>	11-02	
<b>1)MA DESIGN INDIA PRIVATE LIMITED, A COMPANY INCORPORATED IN INDIA HAVING ITS PRINCIPAL PLACE OF BUSINESS AT A-41, SECTOR-80, PHASE-II, NOIDA-201305, U.P. INDIA</b>		
<b>DATE OF REGISTRATION</b>	14/02/2013	
<b>TITLE</b>	WALL ORNAMENT	
<b>PRIORITY NA</b>		

<b>DESIGN NUMBER</b>	245858	
<b>CLASS</b>	02-01	
<b>1)SUMAN BHARTI, PLOT-510, UDHTOG VIHAR PHASE-5, GURGAON-122016, HARYANA, INDIA, A CITIZEN OF INDIA</b>		
<b>DATE OF REGISTRATION</b>	12/06/2012	
<b>TITLE</b>	CORSET	
<b>PRIORITY NA</b>		

<b>DESIGN NUMBER</b>	251235	
<b>CLASS</b>	28-99	
<b>1)HINDUSTAN UNILEVER LIMITED, A COMPANY INCORPORATED UNDER THE INDIAN COMPANIES ACT, 1913, HAVING ITS REGISTERED OFFICE AT UNILEVER HOUSE, B. D. SAWANT MARG, CHAKALA, ANDHERI (EAST), MUMBAI 400099, STATE OF MAHARASHTRA, INDIA</b>		
<b>DATE OF REGISTRATION</b>	28/01/2013	
<b>TITLE</b>	DETERGENT BAR	
<b>PRIORITY</b>		
<b>PRIORITY NUMBER</b>	<b>DATE</b>	<b>COUNTRY</b>
002080341-0001	27/07/2012	OHIM

<b>DESIGN NUMBER</b>	251298	
<b>CLASS</b>	08-09	
<b>1)RAKESHBHAI VITTHALBHAI BHALARA AN INDIAN NATIONAL SOLE PROPRIETOR OF DIVINE OVERSEAS INDIA AN INDIAN PROPRIETORSHIP FIRM HAVING ITS PRINCIPAL PLACE OF BUSINESS AT PLOT NO. 4, SURVEY NO. 229, OPP. SARDAR CASTING, B/H. PARIN FURNITURE, DHOLRA ROAD, GONDAL HIGHWAY, RAJKOT, GUJARAT-INDIA</b>		
<b>DATE OF REGISTRATION</b>	29/01/2013	
<b>TITLE</b>	GLASS PATCH FITTINGS	
<b>PRIORITY NA</b>		

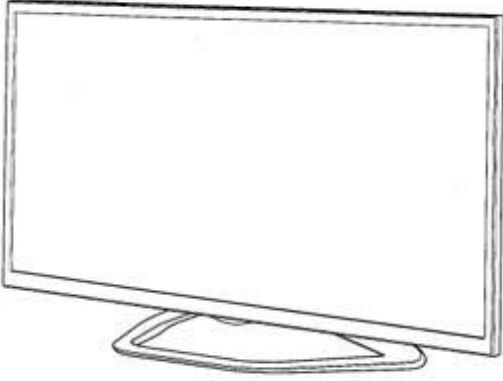
<b>DESIGN NUMBER</b>	251377	
<b>CLASS</b>	12-02	
<b>1)KAUSHIK C. JOSHI AN INDIAN NATIONAL AND RESIDING AT</b> 122, VIBHUSHA BUNGLOWS, OPP. HOMEOPATHIC COLLEGE, BOPAL GHUMA ROAD, BOPAL, AHMEDABAD-58 GUJARAT. (INDIA)		
<b>DATE OF REGISTRATION</b>	01/02/2013	
<b>TITLE</b>	HANDCART	
<b>PRIORITY NA</b>		
<b>DESIGN NUMBER</b>	251411	
<b>CLASS</b>	11-02	
<b>1)ABHIJIT BANSOD, SOLE PROPRIETOR, CARRYING ON BUSINESS AS</b> STUDIO ABD AT LAKEVIEW FARM WHITEFIELD, OLD AIRPORT ROAD, RAMAGONDANAHALLI, BANGALORE, KARNATAKA, INDIA-560066		
<b>DATE OF REGISTRATION</b>	05/02/2013	
<b>TITLE</b>	TABLE CENTERPIECE ORNAMENT	
<b>PRIORITY NA</b>		
<b>DESIGN NUMBER</b>	250757	
<b>CLASS</b>	19-06	
<b>1)BUDH CHETAN JAYENDRA, NATIONALITY INDIAN, ADDRESS AT</b> SATYAM, 33 KETAN SOCIETY, OPP. MEERA APARTMENT, AMBA VIJAY ESTATE, JAMNAGAR 361008, GUJARAT, INDIA		
<b>DATE OF REGISTRATION</b>	07/01/2013	
<b>TITLE</b>	COMPASS	
<b>PRIORITY NA</b>		

<b>DESIGN NUMBER</b>	251789		
<b>CLASS</b>	14-03		
<b>1) LG ELECTRONICS INC.</b> 20 YEOUIDO - DONG, YEONGDEUNGPO - GU, SEOUL 150 - 721, REPUBLIC OF KOREA A CORPORATION INCORPORATED UNDER THE LAWS OF THE REPUBLIC OF KOREA			
<b>DATE OF REGISTRATION</b>	19/02/2013		
<b>TITLE</b>	TELEVISION RECEIVER		
<b>PRIORITY</b>			
<b>PRIORITY NUMBER</b>	<b>DATE</b>	<b>COUNTRY</b>	
30-2012-0039801	20/08/2012	REPUBLIC OF KOREA	
<b>DESIGN NUMBER</b>	251920		
<b>CLASS</b>	07-01		
<b>1) ATER SRL,</b> VIA MASCAGNI 14B, 20020 LAINATE (MI), ITALY, A COMPANY OF ITALY			
<b>DATE OF REGISTRATION</b>	27/02/2013		
<b>TITLE</b>	FOOD CONTAINER		
<b>PRIORITY</b>			
<b>PRIORITY NUMBER</b>	<b>DATE</b>	<b>COUNTRY</b>	
002165357-0001	11/01/2013	OHIM	
<b>DESIGN NUMBER</b>	252149		
<b>CLASS</b>	11-01		
<b>1) MEHTA FAMILY TRUST TRADING AS MEHTA JEWELLERY,</b> NO.43, CP RAMASWAMY ROAD, ABHIRAMAPURAM, CHENNAI-600018			
<b>DATE OF REGISTRATION</b>	06/03/2013		
<b>TITLE</b>	EARRING		
<b>PRIORITY NA</b>			

<b>DESIGN NUMBER</b>	250878	
<b>CLASS</b>	12-16	
<b>1)FORD GLOBAL TECHNOLOGIES, LLC A COMPANY ORGANIZED AND EXISTING UNDER THE LAWS OF UNITED STATES OF AMERICA, HAVING ITS OFFICE AT SUITE 800, 330 TOWN CENTER DRIVE, DEARBORN MICHIGAN-48126, UNITED STATES OF AMERICA</b>		
<b>DATE OF REGISTRATION</b>	09/01/2013	
<b>TITLE</b>	VEHICLE REAR UPPER BUMPER COVER	
<b>PRIORITY</b>		
<b>PRIORITY NUMBER</b>	<b>DATE</b>	<b>COUNTRY</b>
402012100596.0	02/08/2012	GERMANY



<b>DESIGN NUMBER</b>	250902	
<b>CLASS</b>	08-06	
<b>1)(1) GOVINDBHAI MULJIBHAI BHOOT (2) DINESHBHAI MAGANBHAI CHORATIYA (BOTH PARTNERS ARE INDIAN NATIONAL) PARTNER OF SOMNATH METAL (INDIAN PARTNERSHIP FIRM) HAVING PLACE OF BUSINESS AT : 6, PATEL NAGAR, NR. BHALADA INDUSTRIES, 80 FEET ROAD, SORATHIAWADI, RAJKOT-360 001 - GUJARAT (INDIA)</b>		
<b>DATE OF REGISTRATION</b>	10/01/2013	
<b>TITLE</b>	HANDLE	
<b>PRIORITY NA</b>		



<b>DESIGN NUMBER</b>	251014	
<b>CLASS</b>	13-03	
<b>1)PHOENIX CONTACT GMBH &amp; CO. KG, OF FLACHSMARKTSTRASSE. 8, 32825 BLOMBERG, GERMANY, A GERMAN COMPANY</b>		
<b>DATE OF REGISTRATION</b>	17/01/2013	
<b>TITLE</b>	SOCKET FOR AN ELECTRONIC RELAY	
<b>PRIORITY</b>		
<b>PRIORITY NUMBER</b>	<b>DATE</b>	<b>COUNTRY</b>
002081927	31/07/2012	OHIM

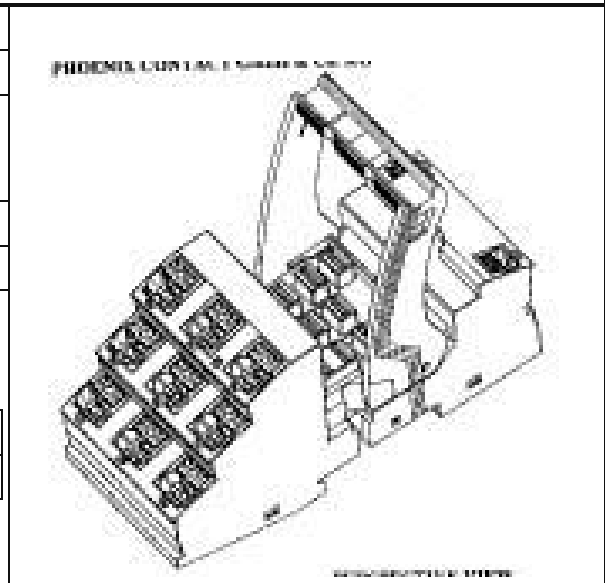

<b>DESIGN NUMBER</b>	250027	
<b>CLASS</b>	08-02	
<b>1)ATLAS COPCO CONSTRUCTION TOOLS AB, SE-10523 STOCKHOLM, SWEDEN, A COMPANY OF SWEDEN</b>		
<b>DATE OF REGISTRATION</b>	07/12/2012	
<b>TITLE</b>	HYDRAULIC HAMMER	
<b>PRIORITY</b>		
<b>PRIORITY NUMBER</b>	<b>DATE</b>	<b>COUNTRY</b>
201230243884.5	13/06/2012	CHINA

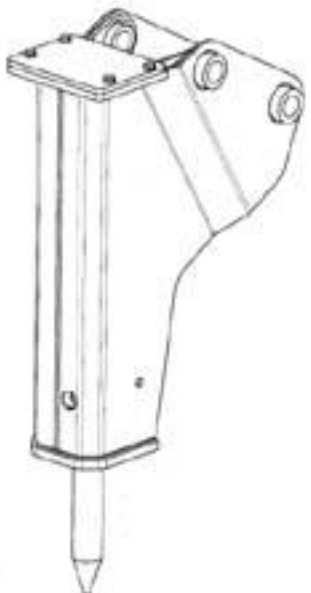

<b>DESIGN NUMBER</b>	252216	
<b>CLASS</b>	08-06	
<b>1)HARESHBHAI BABUBHAI DUDHATRA (ADULT AND INDIAN NATIONAL) SOLE PROPRIETOR OF SHREE GANESH TECHNOCAST (INDIAN PROPRIETORSHIP CONCERN) HAVING PLACE OF BUSINESS AT: 5, AJIVASAHAT, KHIJADAWARI SHERI, THORDA, RAJKOT - GUJARAT (INDIA)</b>		
<b>DATE OF REGISTRATION</b>	08/03/2013	
<b>TITLE</b>	HANDLE	
<b>PRIORITY NA</b>		



<b>DESIGN NUMBER</b>	247902	
<b>CLASS</b>	12-16	
<b>1)MARUTI SUZUKI INDIA LIMITED, OF REGIONAL OFFICE, L &amp; T CHAMBERS, 4TH FLOOR, 16 CAMAC STREET, KOLKATA - 700017, WITH THE HEAD OFFICE AT PLOT NO.-1, NELSON MANDELA ROAD, VASANT KUNJ, NEW DELHI-110070, AN INDIA COMPANY</b>		
<b>DATE OF REGISTRATION</b>	13/09/2012	
<b>TITLE</b>	TAIL LAMP	
<b>PRIORITY NA</b>		





<b>DESIGN NUMBER</b>	251052	
<b>CLASS</b>	12-11	
<b>1)HERO CYCLES LIMITED,</b> HERO NAGAR, G. T. ROAD, LUDHIANA-141003 (PUNJAB), INDIA, (AN INDIAN COMPANY DULY INCORPORATED UNDER THE PROVISIONS OF INDIAN COMPANIES ACT, 1956)		
<b>DATE OF REGISTRATION</b>	21/01/2013	
<b>TITLE</b>	BICYCLE	
<b>PRIORITY NA</b>		

<b>DESIGN NUMBER</b>	251176	
<b>CLASS</b>	08-06	
<b>1)JAYESHBHAI GANDUBHAI SARDHARA (INDIAN NATIONAL) PROPRIETOR OF MAHARAJA TECHNOCAST (INDIAN PROPRIETORSHIP CONCERN) HAVING PLACE OF BUSINESS</b> AT: 4, PARSANA SOCIETY, 50 FEET MAIN ROAD, NR. SORATHIAWADI CIRCLE, RAJKOT-360 002-GUJARAT (INDIA)		
<b>DATE OF REGISTRATION</b>	24/01/2013	
<b>TITLE</b>	HANDLE	
<b>PRIORITY NA</b>		

<b>DESIGN NUMBER</b>	249310	
<b>CLASS</b>	08-06	
<b>1)DILIPBHAI BACHUBHAI HIRPARA (INDIAN NATIONALS) AND SOLE PROPRIETOR OF JANKI DIE-CAST (INDIAN PROPRIETARY CONCERN) HAVING PLACE OF BUSINESS</b> AT-PLOT NO. 834, AJI INDUSTRIAL AREA, NR; SITARAM WAY BRIDGE, OPP: MUNICIPAL WORKSHOP, BHAVNAGAR ROAD, RAJKOT-GUJARAT (INDIA)		
<b>DATE OF REGISTRATION</b>	08/11/2012	
<b>TITLE</b>	HANDLE	
<b>PRIORITY NA</b>		



<b>DESIGN NUMBER</b>	251649	
<b>CLASS</b>	26-05	
<b>1)MA DESIGN INDIA PRIVATE LIMITED, A COMPANY INCORPORATED IN INDIA HAVING ITS PRINCIPAL PLACE OF BUSINESS AT A-41, SECTOR-80, PHASE-II, NOIDA-201305, U.P. INDIA</b>		
<b>DATE OF REGISTRATION</b>	14/02/2013	
<b>TITLE</b>	CHANDELIER	
<b>PRIORITY NA</b>		
<b>DESIGN NUMBER</b>	251657	
<b>CLASS</b>	06-07	
<b>1)MA DESIGN INDIA PRIVATE LIMITED, A COMPANY INCORPORATED IN INDIA HAVING ITS PRINCIPAL PLACE OF BUSINESS AT A-41, SECTOR-80, PHASE-II, NOIDA-201305, U.P. INDIA</b>		
<b>DATE OF REGISTRATION</b>	14/02/2013	
<b>TITLE</b>	MIRROR FRAME	
<b>PRIORITY NA</b>		
<b>DESIGN NUMBER</b>	247152	
<b>CLASS</b>	06-04	
<b>1)M/S. LOCO-MOTIVE DESIGN COMPANY, OF ADDRESS 474 FLOOR PERCEPT HOUSE, S. S. COMMERCIAL ZONE, NAGAVARAPALYA, C. V. RAMAN NAGAR, BANGALORE-568093, WHO ARE A SOLE PROPRIETORSHIP CONCERN</b>		
<b>DATE OF REGISTRATION</b>	14/08/2012	
<b>TITLE</b>	DUSTBIN	
<b>PRIORITY NA</b>		



<b>DESIGN NUMBER</b>	250136	
<b>CLASS</b>	23-04	
<b>1)KONINKLIJKE PHILIPS ELECTRONICS N.V., A COMPANY ORGANIZED AND EXISTING UNDER THE LAWS OF THE KINGDOM OF THE NETHERLANDS, RESIDING AT EINDHOVEN, WHOSE POST-OFFICE ADDRESS IS</b> GROENEWOUDSEWEG 1, 5621 BA, EINDHOVEN, THE NETHERLANDS		
<b>DATE OF REGISTRATION</b>	13/12/2012	
<b>TITLE</b>	AIR HUMIDIFIER	
<b>PRIORITY</b>		
<b>PRIORITY NUMBER</b>	<b>DATE</b>	<b>COUNTRY</b>
002065003-0001	28/06/2012	OHIM

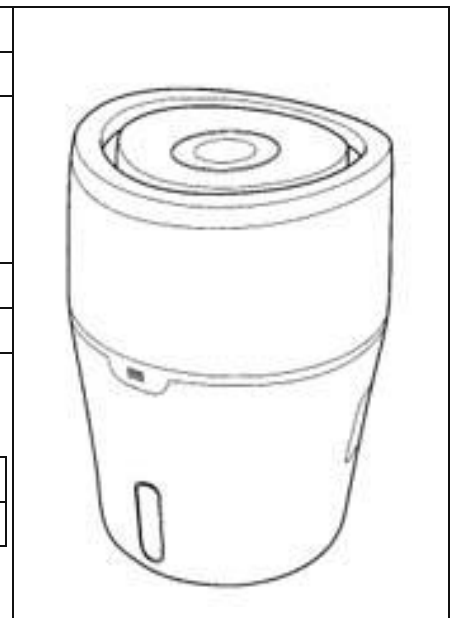

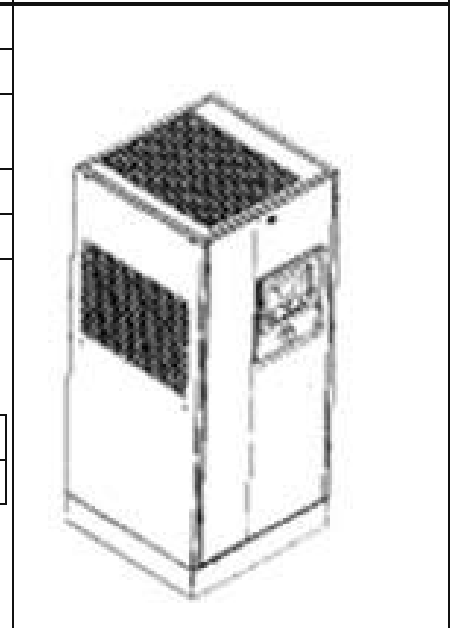

<b>DESIGN NUMBER</b>	251236	
<b>CLASS</b>	15-02	
<b>1)ATLAS COPCO AIRPOWER, NAAMLOZE VENNOOTSCHAP, OF BOOMSESTEENWEG 957, 2610 WILRIJK, BELGIUM, A BELGIAN COMPANY</b>		
<b>DATE OF REGISTRATION</b>	28/01/2013	
<b>TITLE</b>	COMPRESSOR HOUSING	
<b>PRIORITY</b>		
<b>PRIORITY NUMBER</b>	<b>DATE</b>	<b>COUNTRY</b>
201230400985.9	23/08/2012	CHINA



<b>DESIGN NUMBER</b>	251287	
<b>CLASS</b>	08-06	
<b>1)GOPAL M. SAVARIYA, KALPESH K. KANANI AND HASMUKH C. BEDIYA ALL INDIAN NATIONAL PARTNERS OF TARSHI MANUFACTURES AN INDIAN PARTNERSHIP FIRM HAVING ITS PRINCIPAL PLACE OF BUSINESS AT 50 FEET ROAD, PATEL NAGAR SADBHAVNA SOCIETY, STREET NO. 2, BHOJABHAGAT CHOWK, RAJKOT, GUJARAT-INDIA</b>		
<b>DATE OF REGISTRATION</b>	29/01/2013	
<b>TITLE</b>	HANDLE	
<b>PRIORITY NA</b>		



<b>DESIGN NUMBER</b>	251299	
<b>CLASS</b>	08-09	
<b>1) RAKESHBHAI VITTHALBHAI BHALARA AN INDIAN NATIONAL SOLE PROPRIETOR OF DIVINE OVERSEAS INDIA AN INDIAN PROPRIETORSHIP FIRM HAVING ITS PRINCIPAL PLACE OF BUSINESS AT</b> PLOT NO. 4, SURVEY NO. 229, OPP. SARDAR CASTING, B/H. PARIN FURNITURE, DHOLRA ROAD, GONDAL HIGHWAY, RAJKOT, GUJARAT-INDIA		
<b>DATE OF REGISTRATION</b>	29/01/2013	
<b>TITLE</b>	GLASS PATCH FITTINGS	
<b>PRIORITY NA</b>		

<b>DESIGN NUMBER</b>	251399	
<b>CLASS</b>	08-06	
<b>1) (1) BHAVINBHAI NATWARLAL PATEL (2) PARASBHAI KESHUBHAI PARSANA (BOTH THE PARTNERS ARE INDIAN NATIONALS) PARTNERS OF SHIV ENTERPRISE (INDIAN PARTNERSHIP ACT-1932) HAVING PLACE OF BUSINESS AT:</b> 4, GOKULNAGAR, V. N. STREET, NO. 1, NATHJI PAN STRET, 50 FEET ROAD, KOTHARIYA ROAD, RAJKOT-360002-GUJARAT (INDIA)		
<b>DATE OF REGISTRATION</b>	05/02/2013	
<b>TITLE</b>	HANDLE	
<b>PRIORITY NA</b>		

<b>DESIGN NUMBER</b>	249695	
<b>CLASS</b>	31-00	
<b>1) M/S. V-GUARD INDUSTRIES LTD., AN INDIAN COMPANY INCORPORATED UNDER THE COMPANIES ACT OF 1956 WHOSE ADDRESS IS</b> 33/2905 F, VENNALA HIGH SCHOOL ROAD, VENNALA, KOCHI - 682028, KERALA STATE, INDIA		
<b>DATE OF REGISTRATION</b>	26/11/2012	
<b>TITLE</b>	BODY OF MIXER	
<b>PRIORITY NA</b>		

<b>DESIGN NUMBER</b>	250806	
<b>CLASS</b>	02-04	
<b>1)ALPARGATAS S.A., A CORPORATION ORGANIZED AND EXISTING UNDER THE LAWS OF THE BRAZIL WHO ARE BRAZILIAN BY NATIONALITY AND WHOSE ADDRESS IS</b> AVENIDA DOUTOR CARDOSO DE MELO 1336, VILA OLIMPIA, SÃO PAULO, SP, BRAZI, CEP : 04548-005		
<b>DATE OF REGISTRATION</b>	07/01/2013	
<b>TITLE</b>	SHOE	
<b>PRIORITY</b>		
<b>PRIORITY NUMBER</b>	<b>DATE</b>	<b>COUNTRY</b>
002088955	17/08/2012	OHIM



<b>DESIGN NUMBER</b>	251865	
<b>CLASS</b>	19-06	
<b>1)INDIAN WRITING INSTRUMENTS PVT. LTD., 1213, MAKER CHAMBER-V, 221, NARIMAN POINT, MUMBAI-400021.</b> STATE OF MAHARASHTRA INDIA, / A PRIVATE LIMITED COMPANY INCORPORATED UNDER INDIAN COMPANIES ACT., ABOVE ADDRESS		
<b>DATE OF REGISTRATION</b>	26/02/2013	
<b>TITLE</b>	BALL POINT PEN	
<b>PRIORITY NA</b>		





<b>DESIGN NUMBER</b>	250879	
<b>CLASS</b>	12-16	
<b>1)FORD GLOBAL TECHNOLOGIES, LLC A COMPANY ORGANIZED AND EXISTING UNDER THE LAWS OF UNITED STATES OF AMERICA, HAVING ITS OFFICE AT</b> SUITE 800, 330 TOWN CENTER DRIVE, DEARBORN MICHIGAN-48126, UNITED STATES OF AMERICA		
<b>DATE OF REGISTRATION</b>	09/01/2013	
<b>TITLE</b>	VEHICLE REAR LOWER BUMPER COVER	
<b>PRIORITY</b>		
<b>PRIORITY NUMBER</b>	<b>DATE</b>	<b>COUNTRY</b>
402012100596.0	02/08/2012	GERMANY

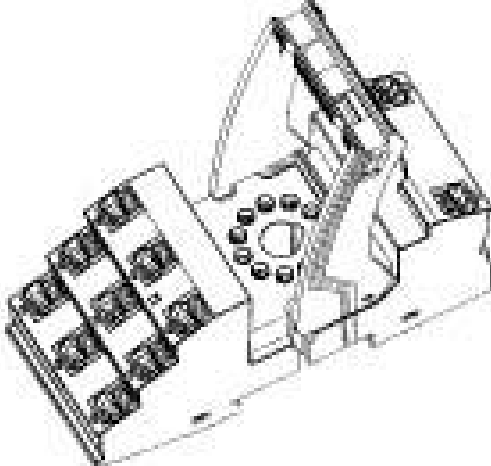

<b>DESIGN NUMBER</b>	250938	
<b>CLASS</b>	12-08	
<b>1)SUZUKI MOTOR CORPORATION, A JAPANESE CORPORATION OF</b> 300, TAKATSUKA-CHO, MINAMI-KU, HAMAMATSU-SHI, SHIZUOKA-KEN, JAPAN		
<b>DATE OF REGISTRATION</b>	10/01/2013	
<b>TITLE</b>	CAR	
<b>PRIORITY NA</b>		

<b>DESIGN NUMBER</b>	251015		
<b>CLASS</b>	13-03		
<b>1)PHOENIX CONTACT GMBH &amp; CO. KG, OF</b> FLACHSMARKTSTRAÙE. 8, 32825 BLOMBERG, GERMANY, A GERMAN COMPANY			
<b>DATE OF REGISTRATION</b>	17/01/2013		
<b>TITLE</b>	SOCKET FOR AN ELECTRONIC RELAY		
<b>PRIORITY</b>			
<b>PRIORITY NUMBER</b>	<b>DATE</b>	<b>COUNTRY</b>	
002081927	31/07/2012	OHIM	

<b>DESIGN NUMBER</b>	193284		
<b>CLASS</b>	23-02		
<b>1)KOHLER FRANCE SAS</b> 60 RUE DE TURENNE, CEDEX 03, 75139, PARIS, FRANCE			
<b>DATE OF REGISTRATION</b>	21/03/2003		
<b>TITLE</b>	LAVATORY		
<b>PRIORITY</b>			
<b>PRIORITY NUMBER</b>	<b>DATE</b>	<b>COUNTRY</b>	
29/178,209	21/03/2003	U.S.A.	

<b>DESIGN NUMBER</b>	250049	
<b>CLASS</b>	02-04	
<b>1)SUNIL MANCHANDA S/O SRI M. L. MANCHANDA, PROPRIETOR OF M/S VERSATILE OPERATIONS, SITUATED AT</b> 49, ARTONI, HIRA LAL KI PIAO, AGRA-MATHURA ROAD, AGRA (U.P.) INDIA		
<b>DATE OF REGISTRATION</b>	10/12/2012	
<b>TITLE</b>	SOLE OF FOOTWEAR	
<b>PRIORITY NA</b>		

<b>DESIGN NUMBER</b>	247787	
<b>CLASS</b>	09-07	
<b>1)WKI HOLDING COMPANY, INC.,</b> 5500 NORTH PEARL STREET, SUITE 400, ROSEMONT, ILLINOIS, 60018, UNITED STATES OF AMERICA		
<b>DATE OF REGISTRATION</b>	10/09/2012	
<b>TITLE</b>	CONTAINER LID	
<b>PRIORITY</b>		
<b>PRIORITY NUMBER</b>	<b>DATE</b>	<b>COUNTRY</b>
29/415,472	10/03/2012	U.S.A.

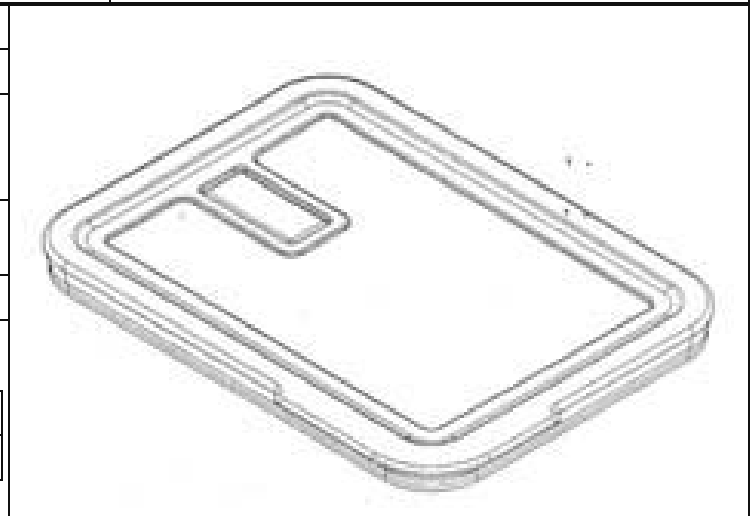

<b>DESIGN NUMBER</b>	248039	
<b>CLASS</b>	26-06	
<b>1)VOLVO LASTVAGNAR AB,</b> OF 405 08 GÖTEBORG, SWEDEN		
<b>DATE OF REGISTRATION</b>	19/09/2012	
<b>TITLE</b>	LIGHT FOR VEHICLE	
<b>PRIORITY</b>		
<b>PRIORITY NUMBER</b>	<b>DATE</b>	<b>COUNTRY</b>
002011965-0008	20/03/2012	OHIM



<b>DESIGN NUMBER</b>	251200	
<b>CLASS</b>	23-02	
<b>1)HANSGROHE SE, OF</b> AUESTR. 5-9, D-77761 SCHILTACH, GERMANY, A GERMAN COMPANY		
<b>DATE OF REGISTRATION</b>	24/01/2013	
<b>TITLE</b>	HAND SHOWER	
<b>PRIORITY</b>		
<b>PRIORITY NUMBER</b>	<b>DATE</b>	<b>COUNTRY</b>
001338073	02/08/2012	OHIM



<b>DESIGN NUMBER</b>	251658	
<b>CLASS</b>	06-07	
<b>1)MA DESIGN INDIA PRIVATE LIMITED, A COMPANY INCORPORATED IN INDIA HAVING ITS PRINCIPAL PLACE OF BUSINESS AT</b> A-41, SECTOR-80, PHASE-II, NOIDA-201305, U.P. INDIA		
<b>DATE OF REGISTRATION</b>	14/02/2013	
<b>TITLE</b>	MIRROR FRAME	
<b>PRIORITY NA</b>		



<b>DESIGN NUMBER</b>	250207	
<b>CLASS</b>	12-11	
<b>1)HONDA MOTOR CO., LTD., A JAPANESE CORPORATION, OF</b> 1-1, MINAMIAOYAMA 2-CHOME, MINATO-KU, TOKYO, JAPAN		
<b>DATE OF REGISTRATION</b>	17/12/2012	
<b>TITLE</b>	MOTORCYCLE	
<b>PRIORITY</b>		
<b>PRIORITY NUMBER</b>	<b>DATE</b>	<b>COUNTRY</b>
2012-014637	20/06/2012	JAPAN



<b>DESIGN NUMBER</b>	249715	
<b>CLASS</b>	09-07	
<b>1)MR. RACHIT ATREY S/O. SH. V. K. ATREY, H NO. 181, AVAS VIKAS COLONY, ROORKEE, PIN CODE : 247667, DISTT HARIDWAR, UTTRAKHAND. NATIONALITY (INDIAN)</b>		
<b>DATE OF REGISTRATION</b>	27/11/2012	
<b>TITLE</b>	BOTTLE FLOW CONTROLLER	
<b>PRIORITY NA</b>		
<b>DESIGN NUMBER</b>	251748	
<b>CLASS</b>	08-06	
<b>1)MUKESHBHAI GORDHANBHAI RAKHOLIYA (ADULT AND INDIAN NATIONAL) AND SOLE PROPRIETOR OF RAMESHWAR METAL (INDIAN PROPRIETORSHIP CONCERN) HAVING PLACE OF BUSINESS AT- 4, PARSANA SOCIETY, 50 FEET MAIN ROAD, B/H. 73 NUMBERS SCHOOL, RAJKOT-GUJARAT-(INDIA)</b>		
<b>DATE OF REGISTRATION</b>	19/02/2013	
<b>TITLE</b>	HANDLE	
<b>PRIORITY NA</b>		
<b>DESIGN NUMBER</b>	251794	
<b>CLASS</b>	28-03	
<b>1)SAI ENGINEERING WORKS., (AN INDIAN SOLE PROPRIETORSHIP CONCERN), HAVING OFFICE AT UMBERGOTHAN NAKA, NEAR HANUMAN TEMPLE, OPP. GOPAL GANESH NAGAR, P.O. AGASHI, TAL. VASAI, DIST. THANE-401301. MAHARASHTRA, INDIA. WHOSE PROPRIETOR IS HEMANT MOHAN KARVIR. (INDIAN NATIONAL) OF ABOVE ADDRESS</b>		
<b>DATE OF REGISTRATION</b>	20/02/2013	
<b>TITLE</b>	HAIR PINS & CLIP	
<b>PRIORITY NA</b>		

<b>DESIGN NUMBER</b>	252025		
<b>CLASS</b>	13-03		
<b>1)RAVAL BHUPENDRA KANTILAL, ADULT, AN INDIAN NATIONAL, HAVING HIS ADDRESS AT, ANANDNAGAR, BLOCK NO. 22, FLAT NO. 262, SECOND FLOOR, OPP: SAMARPAN HOSPITAL, NR. NILKANTH CINEMA, RAJKOT-360002, GUJARAT STATE, INDIA</b>			
<b>DATE OF REGISTRATION</b>	04/03/2013		
<b>TITLE</b>	ELECTRIC PLUG		
<b>PRIORITY NA</b>			
<b>DESIGN NUMBER</b>	250823		
<b>CLASS</b>	08-06		
<b>1)(1) PARESHBHAI V. BHALIYA (2) CHANDRIKABEN P. BHALIYA (3) RAJESH O. KOTADIA (4) GHANSHYAM O. KOTADIA ALL INDIAN NATIONAL PARTNERS OF MARUTI METALS AN INDIAN PARTNERSHIP FIRM HAVING ITS PRINCIPAL PLACE OF BUSINESS AT SOMNATH ESTATE, SHOP NO. 3, NEAR DWARKADHISH ESTATE, VIRANI AGHAT, DHEBAR ROAD(SOUTH), RAJKOT-2, GUJARAT-INDIA</b>			
<b>DATE OF REGISTRATION</b>	07/01/2013		
<b>TITLE</b>	HANDLE		
<b>PRIORITY NA</b>			
<b>DESIGN NUMBER</b>	250881		
<b>CLASS</b>	12-16		
<b>1)FORD GLOBAL TECHNOLOGIES, LLC A COMPANY ORGANIZED AND EXISTING UNDER THE LAWS OF UNITED STATES OF AMERICA, HAVING ITS OFFICE AT SUITE 800, 330 TOWN CENTER DRIVE, DEARBORN MICHIGAN-48126, UNITED STATES OF AMERICA</b>			
<b>DATE OF REGISTRATION</b>	09/01/2013		
<b>TITLE</b>	VEHICLE HOOD		
<b>PRIORITY</b>			
<b>PRIORITY NUMBER</b>	<b>DATE</b>	<b>COUNTRY</b>	
402012100596.0	02/08/2012	GERMANY	



<b>DESIGN NUMBER</b>	193285	
<b>CLASS</b>	23-02	
<b>1) KOHLER FRANCE SAS</b> 60 RUE DE TURENNE, CEDEX 03, 75139, PARIS, FRANCE		
<b>DATE OF REGISTRATION</b>	21/03/2003	
<b>TITLE</b>	LAVATORY	
<b>PRIORITY</b>		
<b>PRIORITY NUMBER</b>	<b>DATE</b>	<b>COUNTRY</b>
29/178, 210	21/03/2003	U.S.A.

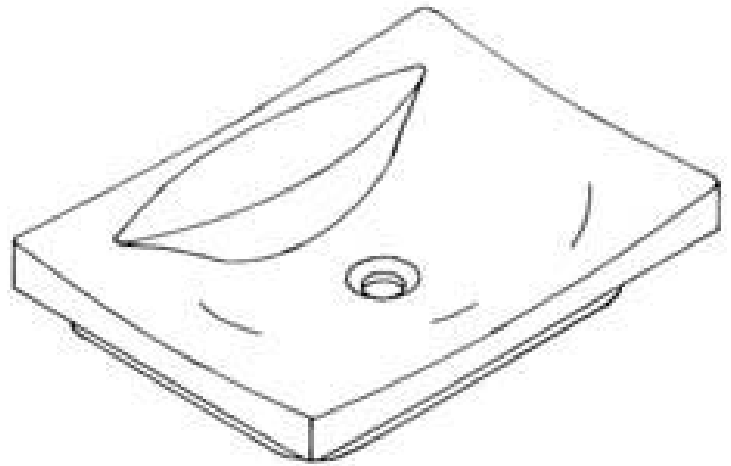

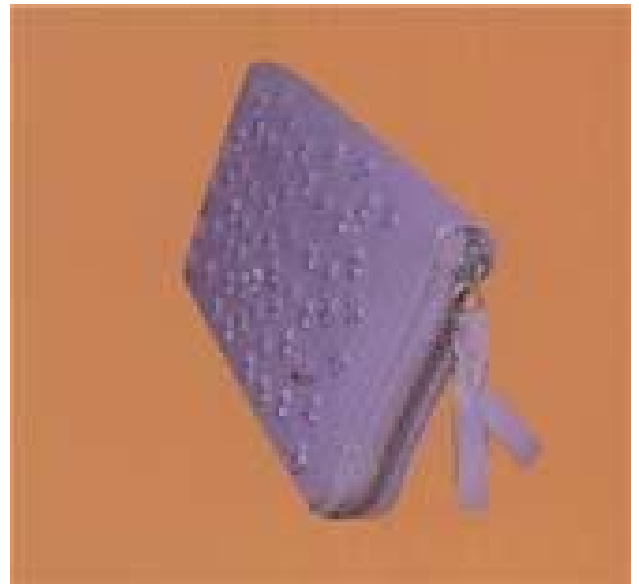

<b>DESIGN NUMBER</b>	250011	
<b>CLASS</b>	03-01	
<b>1) PAHWA INTERNATIONAL, AN INDIAN PARTNERSHIP FIRM WHOSE PARTNERS ARE SURINDER SINGH PAHWA, RAWEL KAUR PHAWA, NIRVER SINGH PAHWA AND FATEH SINGH PAHWA AL INDIAN NATIONALS, HAVING ITS ADDRESS AT</b> F-29, OKHLA INDUSTRIAL AREA, PHASE-I, NEW DELHI-110020, INDIA		
<b>DATE OF REGISTRATION</b>	07/12/2012	
<b>TITLE</b>	PURSE	
<b>PRIORITY NA</b>		



<b>DESIGN NUMBER</b>	250050	
<b>CLASS</b>	02-04	
<b>1) SUNIL MANCHANDA S/O SRI M. L. MANCHANDA, PROPRIETOR OF M/S VERSATILE OPERATIONS, SITUATED AT</b> 49, ARTONI, HIRA LAL KI PIAO, AGRA-MATHURA ROAD, AGRA (U.P.) INDIA		
<b>DATE OF REGISTRATION</b>	10/12/2012	
<b>TITLE</b>	SOLE OF FOOTWEAR	
<b>PRIORITY NA</b>		





<b>DESIGN NUMBER</b>	252229	
<b>CLASS</b>	08-06	
<b>1)KAPILBHAI BALVANTRAI VYAS AND JIGNESHBHAI CHHAGANBHAI GOHEL BOTH INDIAN NATIONAL PARTNER OF RATNAPRABHA HARDWARE AN INDIAN PARTNERSHIP FIRM HAVING ITS PRINCIPAL PLACE OF BUSINESS AT</b> 6, PARSANA SOCIETY, 50 FEET ROAD, KOTHARIYA MAIN ROAD, RAJKOT-2. GUJARAT-INDIA		
<b>DATE OF REGISTRATION</b>	08/03/2013	
<b>TITLE</b>	HANDLE	
<b>PRIORITY NA</b>		

<b>DESIGN NUMBER</b>	251056	
<b>CLASS</b>	12-11	
<b>1)HERO CYCLES LIMITED,</b> HERO NAGAR, G. T. ROAD, LUDHIANA-141003 (PUNJAB), INDIA, (AN INDIAN COMPANY DULY INCORPORATED UNDER THE PROVISIONS OF INDIAN COMPANIES ACT, 1956)		
<b>DATE OF REGISTRATION</b>	21/01/2013	
<b>TITLE</b>	BICYCLE	
<b>PRIORITY NA</b>		

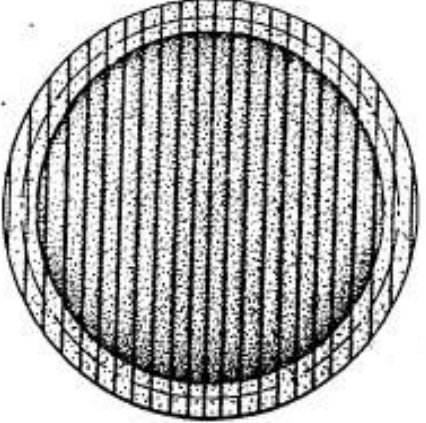
<b>DESIGN NUMBER</b>	251078	
<b>CLASS</b>	05-05	
<b>1)PARRY MURRAY &amp; CO. LTD., COMPANY REGISTERED UNDER THE LAWS OF ENGLAND AND WALES, HAVING ITS PRINCIPAL PLACE OF BUSINESS AT</b> 3RD FLOOR, SIMPSON HOUSE, 6 CHERRY ORCHARD ROAD, CROYDON, CRO 6BA, UNITED KINGDOM		
<b>DATE OF REGISTRATION</b>	21/01/2013	
<b>TITLE</b>	TEXTILE FABRIC	
<b>PRIORITY NA</b>		

<b>DESIGN NUMBER</b>	199615	
<b>CLASS</b>	28-03	
<b>1)JOHNSON &amp; JOHNSON CONSUMER COMPANIES INC., GRANDVIEW ROAD, SKILLMAN, NJ 08558 U.S.A.,</b>		
<b>DATE OF REGISTRATION</b>	28/12/2004	
<b>TITLE</b>	SKIN TREATMENT ARTICLE	
<b>PRIORITY NA</b>		

<b>DESIGN NUMBER</b>	251642	
<b>CLASS</b>	07-01	
<b>1)MA DESIGN INDIA PRIVATE LIMITED, A COMPANY INCORPORATED IN INDIA HAVING ITS PRINCIPAL PLACE OF BUSINESS AT A-41, SECTOR-80, PHASE-II, NOIDA-201305, U.P. INDIA</b>		
<b>DATE OF REGISTRATION</b>	14/02/2013	
<b>TITLE</b>	DISH	
<b>PRIORITY NA</b>		

<b>DESIGN NUMBER</b>	251651	
<b>CLASS</b>	07-06	
<b>1)MA DESIGN INDIA PRIVATE LIMITED, A COMPANY INCORPORATED IN INDIA HAVING ITS PRINCIPAL PLACE OF BUSINESS AT A-41, SECTOR-80, PHASE-II, NOIDA-201305, U.P. INDIA</b>		
<b>DATE OF REGISTRATION</b>	14/02/2013	
<b>TITLE</b>	HOLDER FOR WINE BOTTLE	
<b>PRIORITY NA</b>		

<b>DESIGN NUMBER</b>	251659	
<b>CLASS</b>	06-07	
<b>1)MA DESIGN INDIA PRIVATE LIMITED, A COMPANY INCORPORATED IN INDIA HAVING ITS PRINCIPAL PLACE OF BUSINESS AT A-41, SECTOR-80, PHASE-II, NOIDA-201305, U.P. INDIA</b>		
<b>DATE OF REGISTRATION</b>	14/02/2013	
<b>TITLE</b>	MIRROR FRAME	
<b>PRIORITY NA</b>		



<b>DESIGN NUMBER</b>	248363	
<b>CLASS</b>	25-02	
<b>1)RAJENDRA KRISHNA PATIL, OF RAMAKRISHNA MISSION VIVEKANANDA UNIVERSITY, P.O.: BELUR MATH, HOWRAH-711 202, WEST BENGAL, INDIA, OF THE ABOVE ADDRESS</b>		
<b>DATE OF REGISTRATION</b>	28/09/2012	
<b>TITLE</b>	CHAMFER TOOL	
<b>PRIORITY NA</b>		

<b>DESIGN NUMBER</b>	250152	
<b>CLASS</b>	21-02	
<b>1)FREEWILL SPORTS PRIVATE LIMITED, A COMPANY INCORPORATED UNDER THE INDIAN COMPANIES ACT, 1956 AND HAVING ITS PRINCIPAL PLACE OF BUSINESS AT S32,33, INDUSTRIAL AREA, JALANDHAR 144004</b>		
<b>DATE OF REGISTRATION</b>	13/12/2012	
<b>TITLE</b>	VOLLEY BALL	
<b>PRIORITY NA</b>		

<b>DESIGN NUMBER</b>	251295	
<b>CLASS</b>	08-09	
<b>1)RAKESHBHAI VITTHALBHAI BHALARA AN INDIAN NATIONAL SOLE PROPRIETOR OF DIVINE OVERSEAS INDIA AN INDIAN PROPRIETORSHIP FIRM HAVING ITS PRINCIPAL PLACE OF BUSINESS AT</b> PLOT NO. 4, SURVEY NO. 229, OPP. SARDAR CASTING, B/H. PARIN FURNITURE, DHOLRA ROAD, GONDAL HIGHWAY, RAJKOT, GUJARAT-INDIA		
<b>DATE OF REGISTRATION</b>	29/01/2013	
<b>TITLE</b>	GLASS PATCH FITTINGS	
<b>PRIORITY NA</b>		

<b>DESIGN NUMBER</b>	251444	
<b>CLASS</b>	15-03	
<b>1)TRACTORS AND FARM EQUIPMENT LIMITED, COMPANY INCORPORATED UNDER THE COMPANIES ACT, 1956, HAVING ITS REGISTERED OFFICE AT</b> NO. 861, ANNASALAI, CHENNAI-600002, TAMIL NADU, INDIA		
<b>DATE OF REGISTRATION</b>	06/02/2013	
<b>TITLE</b>	HARVESTER	
<b>PRIORITY NA</b>		

<b>DESIGN NUMBER</b>	251472	
<b>CLASS</b>	26-06	
<b>1)HONDA MOTOR CO., LTD., A JAPANESE CORPORATION, OF</b> 1-1, MINAMI-AOYAMA 2-CHOME, MINATO-KU, TOKYO, JAPAN		
<b>DATE OF REGISTRATION</b>	07/02/2013	
<b>TITLE</b>	FRONT COMBINATION LAMP FOR MOTOR SCOOTER	
<b>PRIORITY</b>		
<b>PRIORITY NUMBER</b>	<b>DATE</b>	<b>COUNTRY</b>
2012-019519	13/08/2012	JAPAN

<b>DESIGN NUMBER</b>	247589	
<b>CLASS</b>	23-02	
<b>1)RABIRUN VINIMAY PVT. LTD., PLOT F3, SECTOR F, VIDYASAGAR INDUSTRIAL PARK, (KHARAGPUR-WBIDC), VILL./MOUZA-JAPHALA, P.O.- JAKPUR, P.S.- KHARAGPUR (L), DIST.- PASCHIM MEDINIPUR-721 301, WEST BENGAL, INDIA</b>		
<b>DATE OF REGISTRATION</b>	03/09/2012	
<b>TITLE</b>	PORTABLE KITCHEN SINK	
<b>PRIORITY NA</b>		
<b>DESIGN NUMBER</b>	250755	
<b>CLASS</b>	19-06	
<b>1)AYRTON AGENCIES PVT LTD, A COMPANY INCORPORATED UNDER THE INDIAN COMPANY'S ACT, ADDRESS AT 535, 2ND FLOOR, KANTA TERRACE, KALBADEVI ROAD, MUMBAI 400002, MAHARASHTRA, INDIA</b>		
<b>DATE OF REGISTRATION</b>	07/01/2013	
<b>TITLE</b>	COMPASS	
<b>PRIORITY NA</b>		
<b>DESIGN NUMBER</b>	251756	
<b>CLASS</b>	01-01	
<b>1)M/S. GOLDEN CHOCOLATES PRIVATE LIMITED, (A COMPANY DULY INCORPORATED UNDER THE INDIAN COMPANIES ACT, 1956), 10123, 1ST FLOOR, LIBRARY ROAD, AZAD MARKET, DELHI-110006</b>		
<b>DATE OF REGISTRATION</b>	19/02/2013	
<b>TITLE</b>	CHOCOLATE	
<b>PRIORITY NA</b>		

<b>DESIGN NUMBER</b>	251826	
<b>CLASS</b>	23-02	
<b>1)EURO-ANCHOR SANITARYWARE INDUSTRIES PVT LTD, A COMPANY INCORPORATED UNDER THE INDIAN COMPANIES ACT, HAVING ITS REGISTERED OFFICE AT</b> OPP. JAMVALI BUS STOP, CHOTILA ROAD, THANGADH 363530, DIST: SURENDRANAGAR, GUJARAT, INDIA		
<b>DATE OF REGISTRATION</b>	22/02/2013	
<b>TITLE</b>	WATER CLOSET	
<b>PRIORITY NA</b>		
<b>DESIGN NUMBER</b>	252115	
<b>CLASS</b>	12-11	
<b>1)TVS MOTOR COMPANY LIMITED, AN INDIAN COMPANY INCORPORATED UNDER THE COMPANIES ACT, 1956, HAVING ITS REGISTERED OFFICE AT</b> JAYALAKSHMI ESTATES'', 29 (OLD NO. 8) HADDOWS ROAD, CHENNAI 600 006, TAMIL NADU, INDIA		
<b>DATE OF REGISTRATION</b>	06/03/2013	
<b>TITLE</b>	SCOOTER	
<b>PRIORITY NA</b>		
<b>DESIGN NUMBER</b>	252147	
<b>CLASS</b>	11-01	
<b>1)MEHTA FAMILY TRUST TRADING AS MEHTA JEWELLERY,</b> NO.43, CP RAMASWAMY ROAD, ABHIRAMAPURAM, CHENNAI-600018		
<b>DATE OF REGISTRATION</b>	06/03/2013	
<b>TITLE</b>	EARRING	
<b>PRIORITY NA</b>		



<b>DESIGN NUMBER</b>	250830	
<b>CLASS</b>	08-08	
<b>1)VALLABHBHAI DEVDASBHAI AMIPARA AN INDIAN NATIONAL SOLE PROPRIETOR OF SIGMA ENTERPRISE AN INDIAN PROPRIETORSHIP FIRM HAVING ITS PRINCIPAL PLACE OF BUSINESS AT</b> SHRI HARI IND. ZONE-2, NR. MUNJAPARA INDUSTRIES, AKASH RESTAURANT STREET, AJI RING ROAD, RAJKOT-2, GUJARAT - INDIA		
<b>DATE OF REGISTRATION</b>	07/01/2013	
<b>TITLE</b>	CURTAIN FITTING	
<b>PRIORITY NA</b>		
<b>DESIGN NUMBER</b>	249927	
<b>CLASS</b>	09-03	
<b>1)VASUDEV JHAMATMAL SAVLANI AN INDIAN NATIONAL AND SOLE PROPRIETOR OF POONAM CONFECTIONERY WORKS HAVING HIS PLACE OF BUSINESS AT</b> PLOT NO. 151, 152/3, NARODA, G.I.D.C., AHMEDABAD-382330 GUJARAT (INDIA)		
<b>DATE OF REGISTRATION</b>	05/12/2012	
<b>TITLE</b>	PACKAGING FOR CHOCOLATES	
<b>PRIORITY NA</b>		
<b>DESIGN NUMBER</b>	250007	
<b>CLASS</b>	03-01	
<b>1)PAHWA INTERNATIONAL, AN INDIAN PARTNERSHIP FIRM WHOSE PARTNERS ARE SURINDER SINGH PAHWA, RAWEL KAUR PHAWA, NIRVER SINGH PAHWA AND FATEH SINGH PAHWA AL INDIAN NATIONALS, HAVING ITS ADDRESS AT</b> F-29, OKHLA INDUSTRIAL AREA, PHASE-I, NEW DELHI-110020, INDIA		
<b>DATE OF REGISTRATION</b>	07/12/2012	
<b>TITLE</b>	SHOULER BAG	
<b>PRIORITY NA</b>		



<b>DESIGN NUMBER</b>	252213
<b>CLASS</b>	07-04
<b>1)NILESHBHAI HASUBHAI GHELANI (ADULT AND INDIAN NATIONAL) PROPRIETOR OF SHREENATHJI ENTERPRISE (INDIAN PROPRIETORSHIP CONCERN) HAVING PLACE OF BUSINESS AT- 12, KRISHNA NAGAR, SWAMINARAYAN CHOWK, RAMDOOT (CLOSE STREET) RAJKOT-GUJARAT (INDIA)</b>	
<b>DATE OF REGISTRATION</b>	08/03/2013
<b>TITLE</b>	GAS LIGHTER
<b>PRIORITY NA</b>	



<b>DESIGN NUMBER</b>	251061
<b>CLASS</b>	12-11
<b>1)HERO CYCLES LIMITED, HERO NAGAR, G. T. ROAD, LUDHIANA-141003 (PUNJAB), INDIA, (AN INDIAN COMPANY DULY INCORPORATED UNDER THE PROVISIONS OF INDIAN COMPANIES ACT, 1956)</b>	
<b>DATE OF REGISTRATION</b>	21/01/2013
<b>TITLE</b>	BICYCLE
<b>PRIORITY NA</b>	





<b>DESIGN NUMBER</b>	249172
<b>CLASS</b>	28-02
<b>1)SH. SONAL JAIN (AN INDIAN NATIONAL) (PORPRIETOR) TRADING AS LITTLE PROFIT TRADING COMPANY, 2804, 2ND FLOOR, MAIN QUTAB ROAD, SADAR BAZAR, DELHI-110006</b>	
<b>DATE OF REGISTRATION</b>	02/11/2012
<b>TITLE</b>	COSMETIC CASE

<b>PRIORITY NA</b>	
--------------------	--





<b>DESIGN NUMBER</b>	249301		
<b>CLASS</b>	15-02		
<b>1)DOSATRON INTERNATIONAL</b> RUE PASCAL F-33370 TRESSES, BORDEAUX FRANCE A FRENCH COMPANY INCORPORATED UNDER THE LAWS OF FRANCE			
<b>DATE OF REGISTRATION</b>	07/11/2012		
<b>TITLE</b>	PUMP COVER		
<b>PRIORITY</b>			
<b>PRIORITY NUMBER</b>	<b>DATE</b>	<b>COUNTRY</b>	
002066563-0004	02/07/2012	OHIM	

<b>DESIGN NUMBER</b>	251573		
<b>CLASS</b>	02-04		
<b>1)VIKAS SINGLA, TRADING AS SARA SPORTS PVT. LTD.,</b> BASEMENT OF S.C.O NO. 82, SECTOR-38C, CHANDIGARH, INDIA, AN INDIAN NATIONAL			
<b>DATE OF REGISTRATION</b>	11/02/2013		
<b>TITLE</b>	SOLE FOR FOOTWEAR		
<b>PRIORITY NA</b>			

<b>DESIGN NUMBER</b>	251647		
<b>CLASS</b>	11-02		
<b>1)MA DESIGN INDIA PRIVATE LIMITED, A COMPANY INCORPORATED</b> <b>IN INDIA HAVING ITS PRINCIPAL PLACE OF BUSINESS AT</b> A-41, SECTOR-80, PHASE-II, NOIDA-201305, U.P. INDIA			
<b>DATE OF REGISTRATION</b>	14/02/2013		
<b>TITLE</b>	BOX (FOR JEWELLERY)		
<b>PRIORITY NA</b>			

<b>DESIGN NUMBER</b>	251655	
<b>CLASS</b>	07-01	
<b>1)MA DESIGN INDIA PRIVATE LIMITED, A COMPANY INCORPORATED IN INDIA HAVING ITS PRINCIPAL PLACE OF BUSINESS AT A-41, SECTOR-80, PHASE-II, NOIDA-201305, U.P. INDIA</b>		
<b>DATE OF REGISTRATION</b>	14/02/2013	
<b>TITLE</b>	BOWL	
<b>PRIORITY NA</b>		

<b>DESIGN NUMBER</b>	251663	
<b>CLASS</b>	06-03	
<b>1)MA DESIGN INDIA PRIVATE LIMITED, A COMPANY INCORPORATED IN INDIA HAVING ITS PRINCIPAL PLACE OF BUSINESS AT A-41, SECTOR-80, PHASE-II, NOIDA-201305, U.P. INDIA</b>		
<b>DATE OF REGISTRATION</b>	14/02/2013	
<b>TITLE</b>	TABLE	
<b>PRIORITY NA</b>		

<b>DESIGN NUMBER</b>	248813	
<b>CLASS</b>	05-05	
<b>1)M/S. BIBA APPARELS PRIVATE LIMITED, AN INDIAN PRIVATE LIMITED COMPANY INCORPORATED UNDER THE PROVISION OF THE COMPANIES ACT, 1956, AND HAVING ITS'S REGISTERED OFFICE AT RELIABLE HOUSE, SITUATED AT HANUMAN SILK MILL COMPOUND, KANJURMARG (WEST), OPP. HUMA MALL, MUMBAI-400078 MAHARASHTRA, INDIA.</b>		
<b>DATE OF REGISTRATION</b>	12/10/2012	
<b>TITLE</b>	TEXTILE FABRIC	
<b>PRIORITY NA</b>		

<b>DESIGN NUMBER</b>	250388		
<b>CLASS</b>	23-02		
<b>1)HANSGROHE SE, OF</b> AUESTR. 5-9, D-77761 SCHILTACH, GERMANY, A GERMAN COMPANY			
<b>DATE OF REGISTRATION</b>	20/12/2012		
<b>TITLE</b>	HEAD SHOWER		
<b>PRIORITY</b>			
<b>PRIORITY NUMBER</b>	<b>DATE</b>	<b>COUNTRY</b>	
001334486-0002	11/07/2012	OHIM	
<b>DESIGN NUMBER</b>	250582		
<b>CLASS</b>	09-03		
<b>1)JALARAM COTTON &amp; PROTEINS LIMITED, A COMPANY INCORPORATED UNDER THE INDIAN COMPANY'S ACT, ADDRESS AT</b> 301, TORAL COMPLEX, JAWAHAR ROAD, RAJKOT 360001, GUJARAT, INDIA			
<b>DATE OF REGISTRATION</b>	01/01/2013		
<b>TITLE</b>	OIL CONTAINER		
<b>PRIORITY NA</b>			
<b>DESIGN NUMBER</b>	251297		
<b>CLASS</b>	08-09		
<b>1)RAKESHBHAI VITTHALBHAI BHALARA AN INDIAN NATIONAL SOLE PROPRIETOR OF DIVINE OVERSEAS INDIA AN INDIAN PROPRIETORSHIP FIRM HAVING ITS PRINCIPAL PLACE OF BUSINESS AT</b> PLOT NO. 4, SURVEY NO. 229, OPP. SARDAR CASTING, B/H. PARIN FURNITURE, DHOLRA ROAD, GONDAL HIGHWAY, RAJKOT, GUJARAT-INDIA			
<b>DATE OF REGISTRATION</b>	29/01/2013		
<b>TITLE</b>	GLASS PATCH FITTINGS		
<b>PRIORITY NA</b>			

<b>DESIGN NUMBER</b>	251357	
<b>CLASS</b>	09-01	
<b>1)HARISH SACHDEV (AN INDIAN NATIONAL) TRADING AS M/S. PLASTIC KING INDUSTRIES, 117, GUPTA COMPOUND, NEAR JHOOLA HOUSE, PIPLIA RAO, A. B. ROAD, INDORE-452017 (M.P.)</b>		
<b>DATE OF REGISTRATION</b>	31/01/2013	
<b>TITLE</b>	BOTTLE	
<b>PRIORITY NA</b>		
<b>DESIGN NUMBER</b>	249816	
<b>CLASS</b>	09-07	
<b>1)MUKESH KHANNA, SOLE PROPRIETOR OF SIMLI COSMETICS WHOSE ADDRESS IS H-45, SECTOR-5, DSIDC, BAWANA INDUSTRIAL AREA, NEW DELHI-110039, INDIA AN INDIAN NATIONAL OF ABOVE ADDRESS</b>		
<b>DATE OF REGISTRATION</b>	03/12/2012	
<b>TITLE</b>	CAP	
<b>PRIORITY NA</b>		
<b>DESIGN NUMBER</b>	250756	
<b>CLASS</b>	19-06	
<b>1)BUDH CHETAN JAYENDRA, NATIONALITY INDIAN, ADDRESS AT SATYAM, 33 KETAN SOCIETY, OPP. MEERA APARTMENT, AMBA VIJAY ESTATE, JAMNAGAR 361008, GUJARAT, INDIA</b>		
<b>DATE OF REGISTRATION</b>	07/01/2013	
<b>TITLE</b>	COMPASS	
<b>PRIORITY NA</b>		

<b>DESIGN NUMBER</b>	252148	
<b>CLASS</b>	11-01	
<b>1)MEHTA FAMILY TRUST TRADING AS MEHTA JEWELLERY, NO.43, CP RAMASWAMY ROAD, ABHIRAMAPURAM, CHENNAI-600018</b>		
<b>DATE OF REGISTRATION</b>	06/03/2013	
<b>TITLE</b>	EARRING	
<b>PRIORITY NA</b>		
<b>DESIGN NUMBER</b>	198502	
<b>CLASS</b>	09-05	
<b>1)HINDUSTAN LEVER LIMITED HINDUSTAN LEVER HOUSE 165/166 BACKBAY RECLAMATION, MUMBAI- 400020, MAHARASHTRA, INDIA</b>		
<b>DATE OF REGISTRATION</b>	14/02/2005	
<b>TITLE</b>	PLAIN MESH BAG	
<b>PRIORITY NA</b>		
<b>DESIGN NUMBER</b>	250820	
<b>CLASS</b>	13-03	
<b>1)LARSEN &amp; TOUBRO LIMITED, AN INDIAN COMPANY INCORPORATED UNDER THE COMPANIES ACT, 1956 OF L &amp; T HOUSE, BALLARD ESTATE, MUMBAI 400001, STATE OF MAHARASHTRA, INDIA</b>		
<b>DATE OF REGISTRATION</b>	07/01/2013	
<b>TITLE</b>	MOULDED CASE CIRCUIT BREAKER	
<b>PRIORITY NA</b>		



<b>DESIGN NUMBER</b>	249999	
<b>CLASS</b>	03-01	
<b>1)PAHWA INTERNATIONAL, AN INDIAN PARTNERSHIP FIRM WHOSE PARTNERS ARE SURINDER SINGH PAHWA, RAWEL KAUR PHAWA, NIRVER SINGH PAHWA AND FATEH SINGH PAHWA AL INDIAN NATIONALS, HAVING ITS ADDRESS AT F-29, OKHLA INDUSTRIAL AREA, PHASE-I, NEW DELHI-110020, INDIA</b>		
<b>DATE OF REGISTRATION</b>	07/12/2012	
<b>TITLE</b>	HAND BAG	
<b>PRIORITY NA</b>		

<b>DESIGN NUMBER</b>	250008	
<b>CLASS</b>	03-01	
<b>1)PAHWA INTERNATIONAL, AN INDIAN PARTNERSHIP FIRM WHOSE PARTNERS ARE SURINDER SINGH PAHWA, RAWEL KAUR PHAWA, NIRVER SINGH PAHWA AND FATEH SINGH PAHWA AL INDIAN NATIONALS, HAVING ITS ADDRESS AT F-29, OKHLA INDUSTRIAL AREA, PHASE-I, NEW DELHI-110020, INDIA</b>		
<b>DATE OF REGISTRATION</b>	07/12/2012	
<b>TITLE</b>	SHOULER BAG	
<b>PRIORITY NA</b>		

<b>DESIGN NUMBER</b>	252215	
<b>CLASS</b>	08-06	
<b>1)HARESHBHAI BABUBHAI DUDHATRA (ADULT AND INDIAN NATIONAL) SOLE PROPRIETOR OF SHREE GANESH TECHNOCAST (INDIAN PROPRIETORSHIP CONCERN) HAVING PLACE OF BUSINESS AT: 5, AJIVASAHAT, KHIJADAWARI SHERI, THORDA, RAJKOT - GUJARAT (INDIA)</b>		
<b>DATE OF REGISTRATION</b>	08/03/2013	
<b>TITLE</b>	HANDLE	
<b>PRIORITY NA</b>		

<b>DESIGN NUMBER</b>	247894	
<b>CLASS</b>	12-05	
<b>1)OTIS ELEVATOR COMPANY, A CORPORATION ORGANIZED UNDER THE LAWS OF THE STATE OF NEW JERSEY,</b> OF 10 FARM SPRINGS, FARMINGTON, CONNECTICUT 06032-2568, UNITED STATES OF AMERICA		
<b>DATE OF REGISTRATION</b>	13/09/2012	
<b>TITLE</b>	ELEVATOR FIXTURE	
<b>PRIORITY</b>		
<b>PRIORITY NUMBER</b>	<b>DATE</b>	<b>COUNTRY</b>
29/417620	05/04/2012	U.S.A.

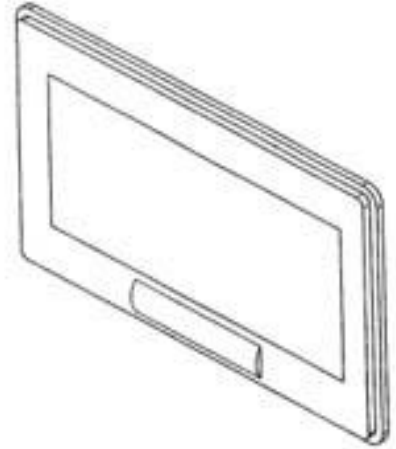



<b>DESIGN NUMBER</b>	251044	
<b>CLASS</b>	24-04	
<b>1)NAVCHETAN ORTHOPAEDIC APPLIANCES., (AN INDIAN SOLE PROPRIETORSHIP CONCERN), HAVING OFFICE AT</b> OPP. S. T. DEPOT, JAMNAGAR-361005 (GUJARAT) WHOSE PROPRIETOR IS AMRUTLAL DEVSHIBHAI CHUDASAMA. (INDIAN NATIONAL) OF ABOVE ADDRESS		
<b>DATE OF REGISTRATION</b>	21/01/2013	
<b>TITLE</b>	ORTHOPEDIC HAND SUPPORT	
<b>PRIORITY NA</b>		



<b>DESIGN NUMBER</b>	251095	
<b>CLASS</b>	11-01	
<b>1)SMT. MANISHA SINGH W/O. SH. RAJESH KUMAR SINGH (NATIONALITY-INDIAN) AT-</b> 44, SITA NAGAR II, 200 FT BYE PASS, AJMER ROAD, JAIPUR (RAJASTHAN) INDIA		
<b>DATE OF REGISTRATION</b>	22/01/2013	
<b>TITLE</b>	PENDANT	
<b>PRIORITY NA</b>		





<b>DESIGN NUMBER</b>	251174	
<b>CLASS</b>	08-06	
<b>1)SANDEEPBHAI GIRDHARBHAI RAIYANI (INDIAN NATIONALS) SOLE PROPRIETOR OF RAJ TECHNOCAST (INDIAN PROPRIETORSHIP CONCERN) HAVING PLACE OF BUSINESS</b> AT - 7, PARSANA SOCIETY, 50 FOOT ROAD, NEAR SORATHIYAWADI CIRCLE, RAJKOT-GUJARAT (INDIA)		
<b>DATE OF REGISTRATION</b>	24/01/2013	
<b>TITLE</b>	HANDLE	
<b>PRIORITY NA</b>		
<b>DESIGN NUMBER</b>	251648	
<b>CLASS</b>	26-01	
<b>1)MA DESIGN INDIA PRIVATE LIMITED, A COMPANY INCORPORATED IN INDIA HAVING ITS PRINCIPAL PLACE OF BUSINESS AT</b> A-41, SECTOR-80, PHASE-II, NOIDA-201305, U.P. INDIA		
<b>DATE OF REGISTRATION</b>	14/02/2013	
<b>TITLE</b>	CANDLE STAND	
<b>PRIORITY NA</b>		
<b>DESIGN NUMBER</b>	251656	
<b>CLASS</b>	19-02	
<b>1)MA DESIGN INDIA PRIVATE LIMITED, A COMPANY INCORPORATED IN INDIA HAVING ITS PRINCIPAL PLACE OF BUSINESS AT</b> A-41, SECTOR-80, PHASE-II, NOIDA-201305, U.P. INDIA		
<b>DATE OF REGISTRATION</b>	14/02/2013	
<b>TITLE</b>	CARD HOLDER	
<b>PRIORITY NA</b>		