

INTRODUCTION

In view of the recent amendment made in the Designs (Amendment) Rules, 2008 with effect from 17/06/2008, Publication of the matter relating to Designs is being published in the Official Journal of The Patent Office. This Journal is being published on weekly basis on every Friday covering the various proceedings on Designs as required according to the provisions of under Rule 22, 25, 27 and 39 of the Design (Amendment) Rules, 2008. All the enquiries on this Official Journal and other information as required by the public should be addressed to the Controller General of Patents, Designs & Trade Marks. Suggestions and comments are requested from all quarters so that the content can be enriched.

COPYRIGHT PUBLICATION

SL NO	CASE NUMBERS	RENEWED ON
1.	184280	19.07.2013
2.	185840	31.07.2013
3.	185871	31.07.2013
4.	186935	17.07.2013
5.	187044	16.07.2013
6.	187839	31.07.2013
7.	188843	17.07.2013
8.	188844	17.07.2013
9.	188900	31.07.2013
10.	189038	31.07.2013
11.	189091	16.07.2013
12.	189238	31.07.2013
13.	189239	31.07.2013
14.	189253	31.07.2013
15.	190103	17.07.2013
16.	190409	31.07.2013
17.	190617	31.07.2013
18.	192334	30.07.2013
19.	243221	19.07.2013
20.	247610	31.07.2013

THE DESIGNS ACT 2000
SECTION 30
DESIGN ASSIGNMENT

The Design stands in the name of MUHAMMED ASLAM NASIR, registered under the Designs Act, 2000 has initially licensed his right to use and exploit the design to TALRIA LIMITED has further licensed his right to use and exploit the design in the Register of Designs in the name as follows:-

Design No.	Class	Name
203293	24-01	INTERSURGICAL UAB, A COMPANY REGISTERED IN LITHUANIA UNDER NUMBER 1150243, OF ARNIONIU 60/28-1, LT 4710 PABRADE, LITHUANIA

THE DESIGNS ACT 2000
SECTION 30
DESIGN ASSIGNMENT

The Design stands in the name of Sanyo Electric Co. Ltd. registered under the Designs Act, 2000 has been assigned in the Register of Designs in the name as follows:-

Design No.	Class	Name
181930	03	HAIER GROUP CORPORATION & QINGDAO HAIER WASHING MACHINE CO. LTD, CHINESE COMPANIES, OF NO. 1, HAIER ROAD, HI-TECH ZONE, QINGDAO, SHANDONG 266101, CHINA

RESTORATION OF LAPSED DESIGNS
UNDER SECTION 12 (2) OF THE DESIGNS ACT, 2000

(01)

An application made under Section 12 (2) of the Designs act, 2000 on **17.12.2012**, for Restoration of **Design No.190617** dated **03.12.2002** in the name of **FMI LIMITED, A COMPANY INCORPORATED UNDER THE INDIAN COMPANIES ACT, AT FEROZEPURE ROAD, LUDHIANA-141001, PUNJAB, INDIA** has been allowed.

(02)

An application made under Section 12 (2) of the Designs act, 2000 on **17.12.2012**, for Restoration of **Design No.189253** dated **20.06.2002** in the name of **FMI LIMITED, A COMPANY INCORPORATED UNDER THE INDIAN COMPANIES ACT, AT FEROZEPURE ROAD, LUDHIANA-141001, PUNJAB, INDIA** has been allowed.

(03)

An application made under Section 12 (2) of the Designs act, 2000 on **17.07.2012**, for Restoration of **Design No.189239** dated **18.06.2002** in the name of **GODREJ SARA LEE LIMITED, A COMPANY INCORPORATED UNDER THE INDIAN COMPANIES ACT, AT PIROJSHAH NAGAR, EASTERN EXPRESS HIGHWAY, VIKHROLI (E), MUMBAI-400079, MAHARASHTRA, INDIA** has been allowed.

(04)

An application made under Section 12 (2) of the Designs act, 2000 on **23.07.2012**, for Restoration of **Design No.189238** dated **18.06.2002** in the name of **GODREJ SARA LEE LIMITED, A COMPANY INCORPORATED UNDER THE INDIAN COMPANIES ACT, AT PIROJSHAH NAGAR, EASTERN EXPRESS HIGHWAY, VIKHROLI (E), MUMBAI-400079, MAHARASHTRA, INDIA** has been allowed.

(05)

An application made under Section 12 (2) of the Designs act, 2000 on **17.07.2012**, for Restoration of **Design No.189038** dated **17.05.2002** in the name of **GALA BRUSH LIMITED, A COMPANY INCORPORATED UNDER THE INDIAN COMPANIES ACT, AT HINDUSTAN KOHINOOR INDL. COMPLEX, GR. FLOOR, OPP. M.T.N.L. GENERAL MANAGER'S OFFICE, L.B.S. MARG, VIKHROLI (W), MUMBAI-400083, MAHARASHTRA, INDIA** has been allowed.

(06)

An application made under Section 12 (2) of the Designs act, 2000 on **05.06.2012**, for Restoration of **Design No.188900** dated **02.05.2002** in the name of **GODREJ SARA LEE LIMITED, A COMPANY INCORPORATED UNDER THE INDIAN COMPANIES ACT, AT PIROJSHAH NAGAR, EASTERN EXPRESS HIGHWAY, VIKHROLI (E), MUMBAI-400059, MAHARASHTRA, INDIA** has been allowed.

(07)

An application made under Section 12 (2) of the Designs act, 2000 on **19.06.2012**, for Restoration of **Design No.188844** dated **23.04.2002** in the name of **JAIN IRRIGATION SYSTEMS LIMITED, A COMPANY REGISTERED IN INDIA, HAVING ITS REGISTERED OFFICE AT JAIN FIELDS, N.H. NO. 6, P.O. BOX 72, BAMBHORI, DIST. JALGAON-425001, STATE OF MAHARASHTRA, INDIA** has been allowed.

(08)



An application made under Section 12 (2) of the Designs act, 2000 on **19.06.2012**, for Restoration of **Design No.188843** dated **23.04.2002** in the name of **JAIN IRRIGATION SYSTEMS LIMITED, A COMPANY REGISTERED IN INDIA, HAVING ITS REGISTERED OFFICE AT JAIN FIELDS, N.H. NO. 6, P.O. BOX 72, BAMBHORI, DIST. JALGAON-425001, STATE OF MAHARASHTRA, INDIA** has been allowed.

(09)

An application made under Section 12 (2) of the Designs act, 2000 on **05.09.2011**, for Restoration of **Design No.185871** dated **21.06.2001** in the name of **GODREJ SARA LEE LIMITED, A COMPANY INCORPORATED UNDER THE INDIAN COMPANIES ACT, AT PIROJSHAH NAGAR, EASTERN EXPRESS HIGHWAY, VIKHROLI (E), MUMBAI-400059, MAHARASHTRA, INDIA** has been allowed.

REGISTRATION OF DESIGNS

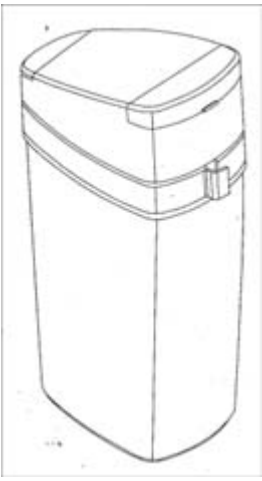
The following designs have been registered. They are now open for public inspection. In the following each entry the Date of Registration is shown. The Priority Number, Priority Date and Priority Country are also shown

DESIGN NUMBER	247075		
CLASS	09-03		
1)GLAXOSMITHKLINE LLC, A US CORPORATION OF ONE FRANKLIN PLAZA, 200 NORTH 16TH STREET, PHILADELPHIA, PENNSYLVANIA 19102, UNITED STATES OF AMERICA			
DATE OF REGISTRATION	09/08/2012		
TITLE	CONTAINER		
PRIORITY NA			
DESIGN NUMBER	251855		
CLASS	12-08		
1)MAN TRUCK & BUS AG, A GERMAN COMPANY OF DACHAUER STR. 667, 80995 MÜNICH, GERMANY.			
DATE OF REGISTRATION	25/02/2013		
TITLE	DRIVER'S CAB OF A UTILITY VEHICLE		
PRIORITY			
PRIORITY NUMBER	DATE	COUNTRY	
002095596	28/08/2012	OHIM	
DESIGN NUMBER	249311		
CLASS	08-06		
1)DILIPBHAI BACHUBHAI HIRPARA (INDIAN NATIONALS) AND SOLE PROPRIETOR OF JANKI DIE-CAST (INDIAN PROPRIETARY CONCERN) HAVING PLACE OF BUSINESS AT-PLOT NO. 834, AJI INDUSTRIAL AREA, NR; SITARAM WAY BRIDGE, OPP: MUNICIPAL WORKSHOP, BHAVNAGAR ROAD, RAJKOT-GUJARAT (INDIA)			
DATE OF REGISTRATION	08/11/2012		
TITLE	HANDLE		
PRIORITY NA			

DESIGN NUMBER	251426	
CLASS	14-03	
1) LG ELECTRONICS INC. 20 YEOUIDO - DONG, YEONGDEUNGPO - GU, SEOUL 150 - 721, REPUBLIC OF KOREA A CORPORATION INCORPORATED UNDER THE LAWS OF THE REPUBLIC OF KOREA		
DATE OF REGISTRATION	05/02/2013	
TITLE	TELEVISION RECEIVER	
PRIORITY		
PRIORITY NUMBER	DATE	COUNTRY
30-2012-0037950	06/08/2012	REPUBLIC OF KOREA

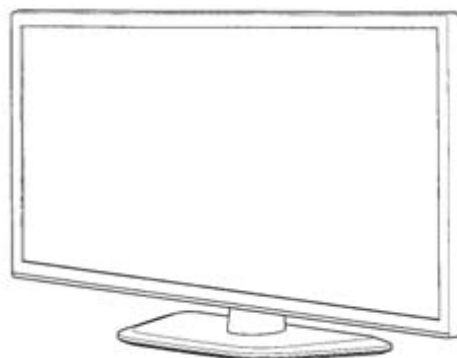

DESIGN NUMBER	249717	
CLASS	09-07	
1) RACHIT ATREY S/O. SH. V. K. ATREY, H NO. 181, AVAS VIKAS COLONY, ROORKEE DIST, HARIDWAR, UTTARAKHAND, INDIA, AN INDIAN NATIONAL, OF THE ABOVE ADDRESS		
DATE OF REGISTRATION	27/11/2012	
TITLE	CAP OF BOTTLE	
PRIORITY NA		



DESIGN NUMBER	246672	
CLASS	08-06	
1) SABIC INNOVATIVE PLASTICS IP B.V., A CORPORATION ORGANIZED AND EXISTING UNDER THE LAWS OF THE NETHERLANDS, OF THE ADDRESS PLASTICSLAAN 1, 4612 PX BERGEN OP ZOOM (NL), NETHERLANDS		
DATE OF REGISTRATION	23/07/2012	
TITLE	GRAB HANDLE	
PRIORITY NA		

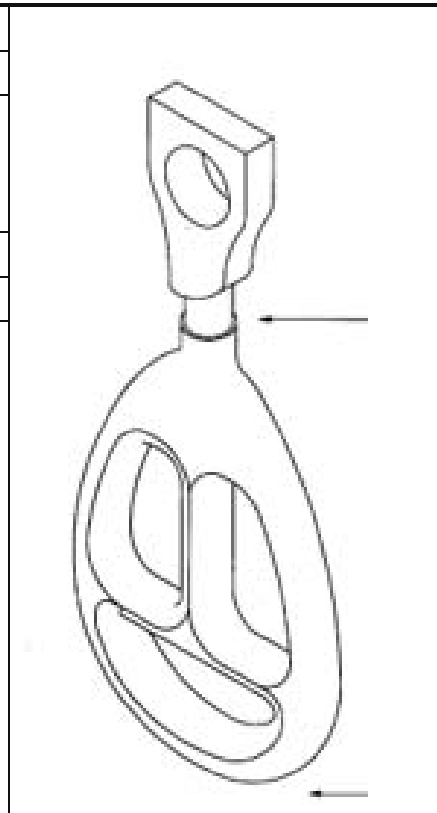

DESIGN NUMBER	249913	
CLASS	13-03	
1)YAZAKI CORPORATION, A JAPANESE CORPORATION OF 4-28, MITA 1-CHOME, MINATO-KU, TOKYO 108-0073, JAPAN		
DATE OF REGISTRATION	03/12/2012	
TITLE	TERMINAL FOR ELECTRICAL CONNECTION	
PRIORITY		
PRIORITY NUMBER	DATE	COUNTRY
2012-013201	04/06/2012	JAPAN

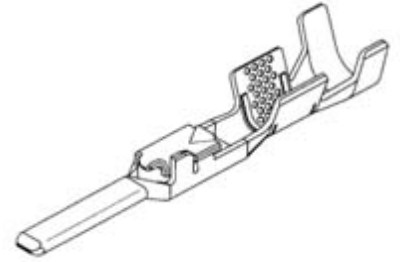

DESIGN NUMBER	250004	
CLASS	03-01	
1)PAHWA INTERNATIONAL, AN INDIAN PARTNERSHIP FIRM WHOSE PARTNERS ARE SURINDER SINGH PAHWA, RAWEL KAUR PHAWA, NIRVER SINGH PAHWA AND FATEH SINGH PAHWA AL INDIAN NATIONALS, HAVING ITS ADDRESS AT F-29, OKHLA INDUSTRIAL AREA, PHASE-I, NEW DELHI-110020, INDIA		
DATE OF REGISTRATION	07/12/2012	
TITLE	HAND BAG	
PRIORITY NA		



DESIGN NUMBER	247543	
CLASS	07-06	
1)MUDITA MULL, OF MULL BUILDINGS, 4, ASHOK MARG, LUCKNOW-226001, INDIA, AN INDIAN CITIZEN.		
DATE OF REGISTRATION	31/08/2012	
TITLE	SALT & PEPPER SHAKER SET	
PRIORITY NA		





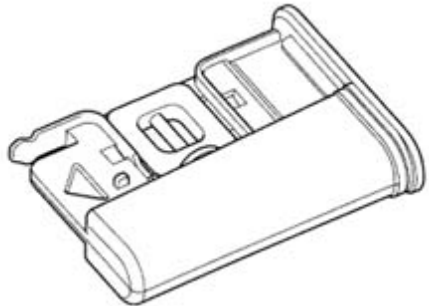

DESIGN NUMBER	250492		
CLASS	08-06		
1)HARESHBHAI BABUBHAI DUDHATRA (ADULT AND INDIAN NATIONAL) SOLE PROPRIETOR OF SHREE GANESH TECHNOCAST (INDIAN PROPRIETORSHIP CONCERN) HAVING PLACE OF BUSINESS AT: 5, AJIVASAHAT, KHIJADAWARI SHERI, THORDA, RAJKOT - GUJARAT (INDIA)			
DATE OF REGISTRATION	27/12/2012		
TITLE	HANDLE		
PRIORITY NA			
DESIGN NUMBER	250814		
CLASS	09-01		
1)TWO DUCKS BEVERAGES PVT. LTD. AN INDIAN COMPANY HAVING HIS ADDRESS AT 703, B-WING, SUNNY SIDE, LOKHANDWALA, ANDHERI-(WEST), MUMBAI, MAHARASHTRA, INDIA, PIN-400053			
DATE OF REGISTRATION	07/01/2013		
TITLE	BOTTLE WITH CAP		
PRIORITY NA			
DESIGN NUMBER	250254		
CLASS	24-04		
1)3M INNOVATIVE PROPERTIES COMPANY, A COMPANY INCORPORATED IN THE STATE OF DELAWARE OF 3M CENTER, SAINT PAUL, MINNESOTA 55133-3427, U.S.A.			
DATE OF REGISTRATION	17/12/2012		
TITLE	ORTHOPEDIC PRESSURE DEVICE		
PRIORITY			
PRIORITY NUMBER	DATE	COUNTRY	
29/424,969	18/06/2012	U.S.A.	

DESIGN NUMBER	251989		
CLASS	12-11		
1)BAJAJ AUTO LIMITED, AN INDIAN COMPANY, INCORPORATED UNDER THE COMPANIES ACT OF 1956, HAVING ITS PRINCIPAL PLACE OF BUSINESS AT NEW 2ND & 3RD FLOOR, KHIVRAJ BUILDING, NO. 616, ANNASALAI, CHENNAI - 600006, STATE OF TAMIL NADU, INDIA, AND REGISTERED OFFICE AT AKURDI, PUNE-411 035, STATE OF MAHARASHTRA, INDIA			
DATE OF REGISTRATION	01/03/2013		
TITLE	MOTORCYCLE		
PRIORITY NA			
DESIGN NUMBER	252040		
CLASS	15-07		
1)LG ELECTRONICS INC. 20 YEOUIDO - DONG, YEONGDEUNGPO - GU, SEOUL 150 - 721, REPUBLIC OF KOREA A CORPORATION INCORPORATED UNDER THE LAWS OF THE REPUBLIC OF KOREA			
DATE OF REGISTRATION	04/03/2013		
TITLE	STORAGE CONTAINER FOR REFRIGERATOR		
PRIORITY			
PRIORITY NUMBER	DATE	COUNTRY	
30-2012-0043474	10/09/2012	REPUBLIC OF KOREA	
DESIGN NUMBER	251911		
CLASS	23-04		
1)RECKITT & COLMAN (OVERSEAS) LIMITED, A BRITISH COMPANY OF 103-105 BATH ROAD, SLOUGH BERKSHIRE, SL1 3UH, UNITED KINGDOM			
DATE OF REGISTRATION	27/02/2013		
TITLE	REFILL FOR INSECT REPELLENT DEVICE		
PRIORITY			
PRIORITY NUMBER	DATE	COUNTRY	
002093369-0003	28/08/2012	OHIM	

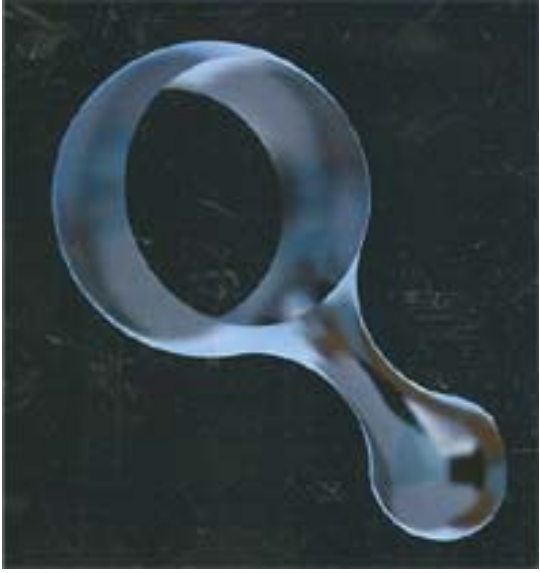
DESIGN NUMBER	251958	
CLASS	06-03	
1)GODREJ & BOYCE MFG. CO. LTD., AN INDIAN COMPANY INCORPORATED UNDER THE COMPANIES ACT, 1913, OF GODREJ INTERIO, PLANT 4, PIROJSHANAGER, VIKHROLI (WEST), MUMBAI-400079, INDIA		
DATE OF REGISTRATION	01/03/2013	
TITLE	DESK	
PRIORITY NA		

DESIGN NUMBER	251308	
CLASS	15-09	
1)ENDICO POWER TOOLS (INDIA), AN INDIAN COMPANY, OF 1276/1, STREET NO. 3, SHIMLAPURI, LUDHIANA-141003, PUNJAB, INDIA		
DATE OF REGISTRATION	30/01/2013	
TITLE	GRINDER BODY OF ROUTER MACHINE	
PRIORITY NA		

DESIGN NUMBER	226732	
CLASS	08-09	
1)H.D. TECHNO INDUSTRIES PLOT NO.P-78, OPP.BAJAJ DHATU, MIDC, HIGNA, NAGPUR-440002, MAHARASHTRA, INDIA		
DATE OF REGISTRATION	11/01/2010	
TITLE	BALUSTRADE MOUNT USED IN GLASS BUILDING	
PRIORITY NA		

DESIGN NUMBER	249945	
CLASS	23-01	
1)CLEVINNO, D.NO-58-24-51; GAVARA STREET; BUCHIRAJUPALEM, VISAKAPATNAM-530027, ANDHRA PRADESH, INDIA, AN INDIAN COMPANY		
DATE OF REGISTRATION	05/12/2012	
TITLE	WATER BOTTLE FILTER	
PRIORITY NA		
		
DESIGN NUMBER	250002	
CLASS	03-01	
1)PAHWA INTERNATIONAL, AN INDIAN PARTNERSHIP FIRM WHOSE PARTNERS ARE SURINDER SINGH PAHWA, RAWEL KAUR PHAWA, NIRVER SINGH PAHWA AND FATEH SINGH PAHWA AL INDIAN NATIONALS, HAVING ITS ADDRESS AT F-29, OKHLA INDUSTRIAL AREA, PHASE-I, NEW DELHI-110020, INDIA		
DATE OF REGISTRATION	07/12/2012	
TITLE	HAND BAG	
PRIORITY NA		
		
DESIGN NUMBER	250042	
CLASS	31-00	
1)KONINKLIJKE PHILIPS ELECTRONICS N.V., A COMPANY ORGANIZED AND EXISTING UNDER THE LAWS OF THE KINGDOM OF THE NETHERLANDS, RESIDING AT EINDHOVEN, WHOSE POST-OFFICE ADDRESS IS GROENEWOUDSEWEG 1, 5621 BA, EINDHOVEN, THE NETHERLANDS		
DATE OF REGISTRATION	10/12/2012	
TITLE	JUICER	
PRIORITY		
PRIORITY NUMBER	DATE	COUNTRY
002057919-0001	14/06/2012	OHIM
		

DESIGN NUMBER	251034	
CLASS	24-99	
1)SPAN BIOTRONICS PRIVATE LIMITED, A COMPANY INCORPORATED UNDER THE LAWS OF INDIA HAVING ITS OFFICE AT 2, VATIKA, 14 BAPISTA ROAD, VILE PARLE (W), MUMBAI-400056, MAHARASHTRA		
DATE OF REGISTRATION	18/01/2013	
TITLE	DISC DISPENSING DEVICE	
PRIORITY NA		
DESIGN NUMBER	251055	
CLASS	12-11	
1)HERO CYCLES LIMITED, HERO NAGAR, G. T. ROAD, LUDHIANA-141003 (PUNJAB), INDIA, (AN INDIAN COMPANY DULY INCORPORATED UNDER THE PROVISIONS OF INDIAN COMPANIES ACT, 1956)		
DATE OF REGISTRATION	21/01/2013	
TITLE	BICYCLE	
PRIORITY NA		
DESIGN NUMBER	251118	
CLASS	08-06	
1)MAHESHBHAI SHIVALALBHAI GAJERA, AN INDIAN NATIONAL PROPRIETOR OF SHREE HARIKRUPA DIE CASTING AN INDIAN PROPRIETORSHIP FIRM HAVING ITS PRINCIPAL PLACE OF BUSINESS AT K-1, 242/17, B/4 MEL-TECH, NEAR TURBO BEARING, AJI VASAHAAT GIDC, RAJKOT-360002, GUJARAT-INDIA		
DATE OF REGISTRATION	22/01/2013	
TITLE	HANDLE	
PRIORITY NA		

DESIGN NUMBER	251188	
CLASS	30-02	
1)PANELTIM NV, A BELGIAN COMPANY OF INDUSTRIELAAN 38, 8810 LICHTERVELDE, BELGIUM		
DATE OF REGISTRATION	24/01/2013	
TITLE	VENTILATION PANEL	
PRIORITY NA		

DESIGN NUMBER	250579	
CLASS	09-07	
1)NATIONAL PLASTICS, 91 BASANT AVENUE, AMRITSAR-143011, INDIA, AN INDIAN COMPANY		
DATE OF REGISTRATION	01/01/2013	
TITLE	FOAM NOZZLE OF TRIGGER SPRAYER	
PRIORITY NA		

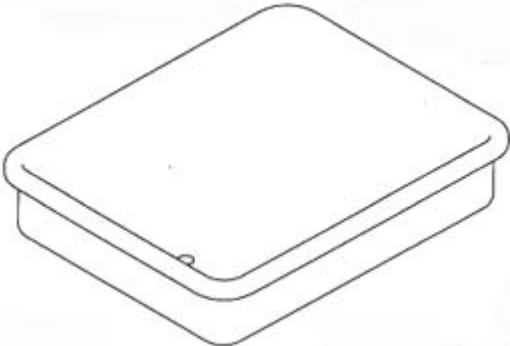

DESIGN NUMBER	250971	
CLASS	21-01	
1)YOSHIRITSU KABUSHIKI KAISHA, 1563, KOSHIBE, OYODO-CHO, YOSHINO-GUN, NARA, JAPAN,		
DATE OF REGISTRATION	14/01/2013	
TITLE	ASSEMBLING TOY BLOCK	
PRIORITY		
PRIORITY NUMBER	DATE	COUNTRY
2012-017789	26/07/2012	JAPAN

DESIGN NUMBER	251003	
CLASS	22-06	
1)DESIGNLIPI PROJECTS PRIVATE LIMITED, AN INDIAN COMPANY REGISTERED UNDER COMPANIES ACT, 1956 OF 67, ELLIOT ROAD, KOLKATA-700016		
DATE OF REGISTRATION	17/01/2013	
TITLE	MOSQUITO REPLENT DEVICE	
PRIORITY NA		

DESIGN NUMBER	252038		
CLASS	15-07		
1)LG ELECTRONICS INC. 20 YEUIDO - DONG, YEONGDEUNGPO - GU, SEOUL 150 - 721, REPUBLIC OF KOREA A CORPORATION INCORPORATED UNDER THE LAWS OF THE REPUBLIC OF KOREA			
DATE OF REGISTRATION	04/03/2013		
TITLE	STORAGE CONTAINER FOR REFRIGERATOR		
PRIORITY			
PRIORITY NUMBER	DATE	COUNTRY	
30-2012-0043478	10/09/2012	REPUBLIC OF KOREA	

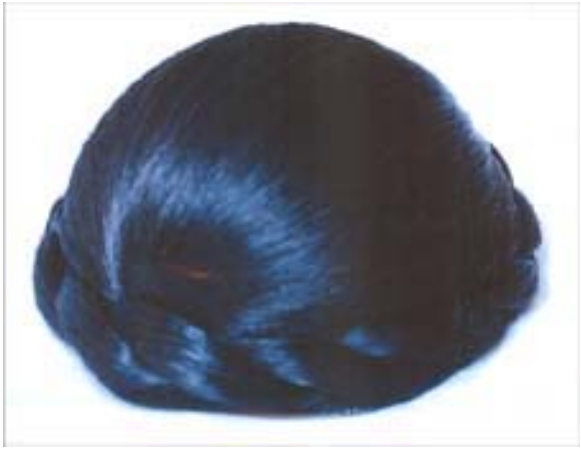
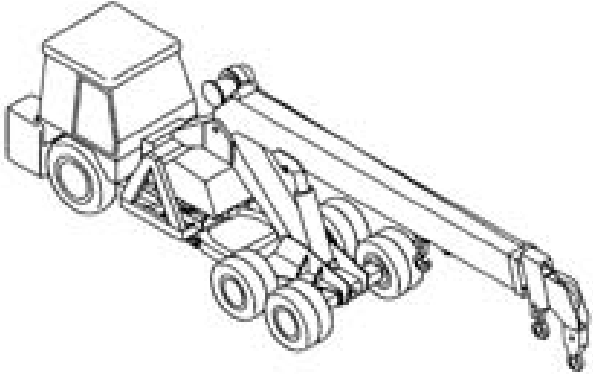
DESIGN NUMBER	252461		
CLASS	13-02		
1)CROMPTON GREAVES LIMITED, (AN INDIAN COMPANY), AVANTHA HOUSE, 6TH FLOOR, DR. ANNIE BESANT ROAD, WORLI, MUMBAI- 400030, MAHARASHTRA, INDIA			
DATE OF REGISTRATION	20/03/2013		
TITLE	VOLTAGE TRANSFORMER		
PRIORITY NA			

DESIGN NUMBER	251834	
CLASS	07-05	
1)PHILIPS ELECTRONICS INDIA LIMITED, A COMPANY INCORPORATED UNDER THE PROVISIONS OF THE INDIAN COMPANIES ACT, 1956 AND HAVING OFFICE AT PHILIPS INNOVATION CAMPUS, MANYATA TECH PARK, NAGAVARA, BANGALORE-560045, INDIA		
DATE OF REGISTRATION	22/02/2013	
TITLE	DRY IRON	
PRIORITY NA		
DESIGN NUMBER	251948	
CLASS	28-04	
1)MANSA DEVI BHARADWAJ. (INDIAN NATIONAL) OF ROOM NO. 1, KALAVATI BHAVAN, BABU SHETH CHAWL, SHANTILAL COMPOUND, JAWAHAR NAGAR, KHAR (EAST), MUMBAI-400051, MAHARASHTRA, INDIA.		
DATE OF REGISTRATION	28/02/2013	
TITLE	HAIR BROOCH	
PRIORITY NA		
DESIGN NUMBER	251231	
CLASS	12-05	
1)TADANO LTD., A JAPANESE CORPORATION OF KO-34, SHINDEN-CHO, TAKAMATSU-SHI, KAGAWA 761-0185, JAPAN		
DATE OF REGISTRATION	28/01/2013	
TITLE	CRANE TRUCK	
PRIORITY NA		

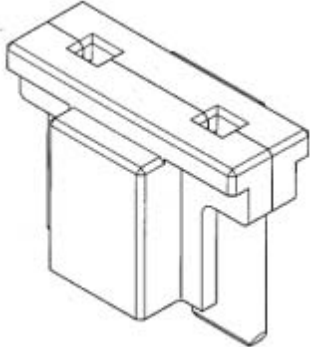
DESIGN NUMBER	251275		
CLASS	09-01		
1)M/S. NEST FOODS & BEVERAGES CORPORATION, V/34A, PALLIPURAM, MARAMPILLY, ALUVA, ERNAKULAM DISTRICT, KERALA, INDIA			
DATE OF REGISTRATION	29/01/2013		
TITLE	BOTTLE		
PRIORITY NA			
DESIGN NUMBER	251311		
CLASS	15-09		
1)ENDICO POWER TOOLS (INDIA), AN INDIAN COMPANY, OF 1276/1, STREET NO. 3, SHIMLAPURI, LUDHIANA-141003, PUNJAB, INDIA			
DATE OF REGISTRATION	30/01/2013		
TITLE	END COVER OF ROUTER MACHINE		
PRIORITY NA			
DESIGN NUMBER	251427		
CLASS	13-03		
1)YAZAKI CORPORATION, A JAPANESE CORPORATION OF 4-28, MITA 1-CHOME, MINATO-KU, TOKYO 108-0073 JAPAN			
DATE OF REGISTRATION	05/02/2013		
TITLE	FUSE		
PRIORITY			
PRIORITY NUMBER	DATE	COUNTRY	
2012-019095	08/08/2012	JAPAN	

DESIGN NUMBER	250005	
CLASS	03-01	
1)PAHWA INTERNATIONAL, AN INDIAN PARTNERSHIP FIRM WHOSE PARTNERS ARE SURINDER SINGH PAHWA, RAWEL KAUR PHAWA, NIRVER SINGH PAHWA AND FATEH SINGH PAHWA AL INDIAN NATIONALS, HAVING ITS ADDRESS AT F-29, OKHLA INDUSTRIAL AREA, PHASE-I, NEW DELHI-110020, INDIA		
DATE OF REGISTRATION	07/12/2012	
TITLE	HAND BAG	
PRIORITY NA		

DESIGN NUMBER	250493	
CLASS	08-06	
1)HARESHBHAI BABUBHAI DUDHATRA (ADULT AND INDIAN NATIONAL) SOLE PROPRIETOR OF SHREE GANESH TECHNOCAST (INDIAN PROPRIETORSHIP CONCERN) HAVING PLACE OF BUSINESS AT: 5, AJIVASAHAT, KHIJADAWARI SHERI, THORDA, RAJKOT - GUJARAT (INDIA)		
DATE OF REGISTRATION	27/12/2012	
TITLE	HANDLE	
PRIORITY NA		

DESIGN NUMBER	250255	
CLASS	24-04	
1)3M INNOVATIVE PROPERTIES COMPANY, A COMPANY INCORPORATED IN THE STATE OF DELAWARE OF 3M CENTER, SAINT PAUL, MINNESOTA 55133-3427, U.S.A.		
DATE OF REGISTRATION	17/12/2012	
TITLE	ORTHOPEDIC PRESSURE DEVICE	
PRIORITY		
PRIORITY NUMBER	DATE	COUNTRY
29/424,973	18/06/2012	U.S.A.

DESIGN NUMBER	250331	
CLASS	02-02	
1)M/S. EXPOSE APPARELS OF 11266, NEW ROHTAK ROAD, DORIWALAN, GALI NO. 2, KAROL BAGH, NEW DELHI-110005, INDIA, A SOLE PROPRIETORSHIP CONERN WHOSE PROPRIETOR IS SUBODH KUMAR, INDIAN NATIONAL OF ABOVE ADDRESS		
DATE OF REGISTRATION	19/12/2012	
TITLE	PANT	
PRIORITY NA		
DESIGN NUMBER	252041	
CLASS	10-04	
1)BHARAT HEAVY ELECTRICALS LIMITED, WITH ONE OF ITS REGIONAL OFFICES AT REGIONAL OPERATIONS DIVISION (ROD), PLOT NO. 9/1, DJ BLOCK, 3RD FLOOR, KARUNAMOYEE, SLAT LAKE CITY, KOLKATA-700091, HAVING ITS REGISTERED OFFICE AT BHEL HOUSE SIRI FORT, NEW DELHI-110049, INDIA, AN INDIAN COMPANY.		
DATE OF REGISTRATION	04/03/2013	
TITLE	ELECTRONIC WATER LEVEL INDICATOR	
PRIORITY NA		
DESIGN NUMBER	252464	
CLASS	13-02	
1)CROMPTON GREAVES LIMITED, (AN INDIAN COMPANY), AVANTHA HOUSE, 6TH FLOOR, DR. ANNIE BESANT ROAD, WORLI, MUMBAI-400030, MAHARASHTRA, INDIA		
DATE OF REGISTRATION	20/03/2013	
TITLE	VOLTAGE TRANSFORMER	
PRIORITY NA		

DESIGN NUMBER	252618	
CLASS	15-04	
1)GURJIWAN AGRO INDUSTRIES OF V.P.O. HARRAIPUR, TEHSIL-BATHINDA, DISTT. BATHINDA-151201 (PUNJAB), INDIA, AN INDIAN PROPRIETORSHIP FIRM WHOSE PROPRIETOR IS S. ATMA SINGH, INDIAN NATIONAL OF ABOVE ADDRESS		
DATE OF REGISTRATION	22/03/2013	
TITLE	OPERATING LEVER OF LEVELLER	
PRIORITY NA		
DESIGN NUMBER	249623	
CLASS	31-00	
1)PROTECH APPLIANCES (P) LTD, AN INDIAN COMPANY INCORPORATED UNDER THE COMPANIES ACT, 1956 OF DOOR NO. 39/5173 D, 3RD FLOOR, MAIN AVENUE, K. C. ABRAHAM ROAD, PANAMPILLY NAGAR, KOCHI 682036, STATE OF KERALA, INDIA		
DATE OF REGISTRATION	21/11/2012	
TITLE	SODA MAKER	
PRIORITY NA		
DESIGN NUMBER	251772	
CLASS	29-99	
1)SURENDRA KHANDELWAL, AN INDIAN CITIZEN, PROPRIETOR OF SP COMBINED, AN INDIAN PROPRIETORSHIP FIRM AT 306, BALAJI CORPORATE, 19/1, NEW PALASIA, INDORE (M.P.) PIN-452001, INDIA		
DATE OF REGISTRATION	19/02/2013	
TITLE	GAS SAFETY DEVICE	
PRIORITY NA		

DESIGN NUMBER	251954		
CLASS	06-03		
1)GODREJ & BOYCE MFG. CO. LTD., AN INDIAN COMPANY INCORPORATED UNDER THE COMPANIES ACT, 1913, OF GODREJ INTERIO, PLANT 4, PIROJSHANAGER, VIKHROLI (WEST), MUMBAI-400079, INDIA			
DATE OF REGISTRATION	01/03/2013		
TITLE	DESK		
PRIORITY NA			
DESIGN NUMBER	251278		
CLASS	28-02		
1)ELC MANAGEMENT LLC, A DELAWARE CORPORATION, HAVING AN OFFICE AT 155 PINELAWN ROAD, SUITE 345 SOUTH, MELVILLE, NY 11747, USA			
DATE OF REGISTRATION	29/01/2013		
TITLE	COSMETIC CONTAINER		
PRIORITY			
PRIORITY NUMBER	DATE	COUNTRY	
29/428,694	02/08/2012	U.S.A.	
DESIGN NUMBER	251305		
CLASS	15-09		
1)ENDICO POWER TOOLS (INDIA), AN INDIAN COMPANY, OF 1276/1, STREET NO. 3, SHIMLAPURI, LUDHIANA-141003, PUNJAB, INDIA			
DATE OF REGISTRATION	30/01/2013		
TITLE	BODY OF ROUTER MACHINE		
PRIORITY NA			

DESIGN NUMBER	249708
CLASS	09-03
1)ASTRON PACKAGING LIMITED, AN INDIAN COMPANY INCORPORATED UNDER THE COMPANIES ACT, 1956 OF 22-23-34, MAHAGUJARAT INDUSTRIAL ESTATE, SARKHEJ BAVLA HIGHWAY, VILLAGE-MORAIYA, DIST. AHMEDABAD-382210, STATE OF GUJARAT, INDIA	
DATE OF REGISTRATION	26/11/2012
TITLE	PACKAGING
PRIORITY NA	

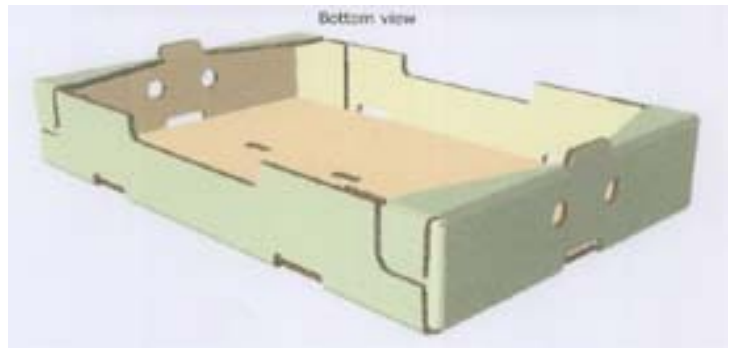

DESIGN NUMBER	249852		
CLASS	15-09		
1)SANDVIK INTELLECTUAL PROPERTY AB, OF SE-811 81 SANDVIKEN, SWEDEN, A SWEDISH COMPANY			
DATE OF REGISTRATION	03/12/2012		
TITLE	CRUSHING APPARATUS		
PRIORITY			
PRIORITY NUMBER	DATE	COUNTRY	
001330674-0001	13/06/2012	OHIM	

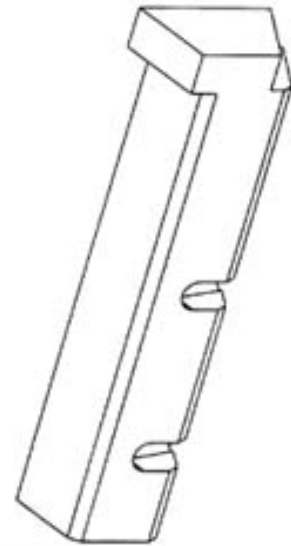

DESIGN NUMBER	246810		
CLASS	15-99		
1)PROPEL INDUSTRIES PRIVATE LIMITED, (A COMPANY REGISTERED UNDER THE INDIAN COMPANIES ACT, 1956) REPRESENTED BY ITS SENIOR VICE PRESIDENT MR. R. DURAISAMY, HAVING ITS ADDRESS AT SF 663, RAVATHUR MAIN ROAD, RAVATHUR PIRIVU, TRICHY ROAD, COIMBATORE-641103			
DATE OF REGISTRATION	30/07/2012		
TITLE	VERTICAL SHAFT IMPACT CRUSHER		
PRIORITY NA			



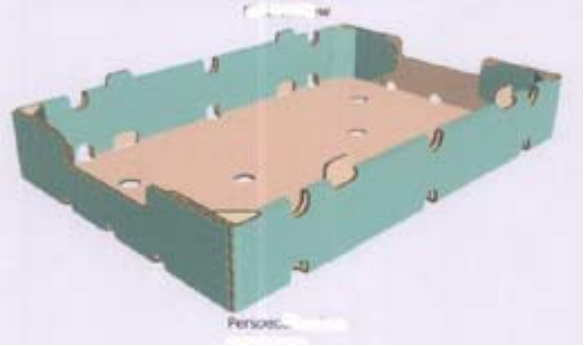

DESIGN NUMBER	249885	
CLASS	15-07	
1)GODREJ & BOYCE MFG. CO. LTD., AN INDIAN COMPANY INCORPORATED UNDER THE COMPANIES ACT 1913, OF GODREJ INTERIO, PLANT 4, PIROJSHANAGER, VIKHROLI (WEST), MUMBAI-400079, INDIA		
DATE OF REGISTRATION	04/12/2012	
TITLE	REFRIGERATOR	
PRIORITY NA		

DESIGN NUMBER	249923	
CLASS	09-03	
1)ASTRON PACKAGING LIMITED, AN INDIAN COMPANY INCORPORATED UNDER THE COMPANIES ACT, 1956 OF 22-23-34, MAHAGUJARAT INDUSTRIAL ESTATE, SARKHEJ BAVLA HIGHWAY, VILLAGE-MORAIYA, DIST. AHMEDABAD-382210, STATE OF GUJARAT, INDIA		
DATE OF REGISTRATION	05/12/2012	
TITLE	PACKAGING	
PRIORITY NA		

DESIGN NUMBER	250009	
CLASS	03-01	
1)PAHWA INTERNATIONAL, AN INDIAN PARTNERSHIP FIRM WHOSE PARTNERS ARE SURINDER SINGH PAHWA, RAWEL KAUR PHAWA, NIRVER SINGH PAHWA AND FATEH SINGH PAHWA AL INDIAN NATIONALS, HAVING ITS ADDRESS AT F-29, OKHLA INDUSTRIAL AREA, PHASE-I, NEW DELHI-110020, INDIA		
DATE OF REGISTRATION	07/12/2012	
TITLE	SHOULER BAG	
PRIORITY NA		

DESIGN NUMBER	250090		
CLASS	08-06		
1)JAYESHBHAI GANDEBHAI SARDHARA (INDIAN NATIONAL) PROPRIETOR OF MAHARAJA TECHNOCAST (INDIAN PROPRIETORSHIP CONCERN) HAVING PLACE OF BUSINESS AT: 4, PARSANA SOCIETY, 50 FEET MAIN ROAD, NR. SORATHIAWADI CIRCLE, RAJKOT-360002-GUJARAT (INDIA)			
DATE OF REGISTRATION	13/12/2012		
TITLE	HANDLE		
PRIORITY NA			
DESIGN NUMBER	251040		
CLASS	23-01		
1)HANS GROHE SE, OF AUESTR. 5-9, D-77761 SCHILTACH, GERMANY, A GERMAN COMPANY.			
DATE OF REGISTRATION	18/01/2013		
TITLE	SANITARY FAUCET		
PRIORITY			
PRIORITY NUMBER	DATE	COUNTRY	
001337570-0007	31/07/2012	OHIM	
DESIGN NUMBER	251115		
CLASS	08-06		
1)(1) MITESHBHAI B. PIPALIYA (2) HITESHBHAI M. PIPALIYA (3) JIGNESHBHAI B. HIRAPARA ALL INDIAN NATIONAL PARTNERS OF PATEL DIE CASTING AN INDIAN PARTNERSHIP FIRM HAVING ITS PRINCIPAL PLACE OF BUSINESS AT PATELNAGAR-4, OPP. SATYANARAYAN MILL, 80 FEET MAIN ROAD, RAJKOT, GUJARAT-INDIA			
DATE OF REGISTRATION	22/01/2013		
TITLE	HANDLE		
PRIORITY NA			

DESIGN NUMBER	251182	
CLASS	23-04	
1)AVTAR SINGH S/O SH. RANJIT SINGH, R/O 23 A, KHOKHAR COMPLEX, NEW OFFICER COLONY, PATIALA, PUNJAB, INDIA		
DATE OF REGISTRATION	24/01/2013	
TITLE	CEILING FAN	
PRIORITY NA		

DESIGN NUMBER	250495	
CLASS	08-06	
1)(1) JAGDISHBHAI DAMJIBHAI THUMMAR (2) MAHESHBHAI GOPALBHAI THUMMAR (3) ALPESHBHA GOPALBHAI THUMMAR (4) ASHOKBHAI DAMJIBHAI THUMMAR (ALL THE PARTNERS ARE INDIAN NATIONALS) PARTNERS OF SHREE RAMKRISHNA TECHNOCAST (INDIAN PARTNERSHIP FIRM) HAVING PLACE OF BUSINESS AT - SHREE HARI IND. ZONE MAIN STREET, NUMBER-5, CORNER, N.H. 8B, KOTHARIYA RINGROAD, NR. MEERAUDHYOG, RAJKOT-360002, GUJARAT (INDIA)		
DATE OF REGISTRATION	27/12/2012	
TITLE	HANDLE	
PRIORITY NA		

DESIGN NUMBER	250821	
CLASS	13-03	
1)LARSEN & TOUBRO LIMITED, AN INDIAN COMPANY INCORPORATED UNDER THE COMPANIES ACT, 1956 OF L & T HOUSE, BALLARD ESTATE, MUMBAI 400001, STATE OF MAHARASHTRA, INDIA		
DATE OF REGISTRATION	07/01/2013	
TITLE	MOULDED CASE CIRCUIT BREAKER	
PRIORITY NA		

DESIGN NUMBER	250138	
CLASS	14-03	
1)JVC KENWOOD CORPORATION, A JAPANESE CORPORATION OF 12, MORIYA-CHO 3-CHOME, KANAGAWA-KU, YOKOHAMA-SHI, KANAGAWA, JAPAN		
DATE OF REGISTRATION	13/12/2012	
TITLE	PORTABLE WIRELESS COMMUNICATION DEVICE	
PRIORITY NA		

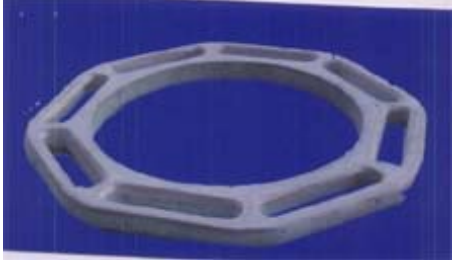

DESIGN NUMBER	252026	
CLASS	17-04	
1)PARMINDER SINGH UBHI, 3357, STREET NO. 4, CHET SINGH NAGAR, GILL ROAD, LUDHIANA-141 003 (PUNJAB) INDIA BEING INDIAN NATIONALS OF THE ABOVE ADDRESS		
DATE OF REGISTRATION	04/03/2013	
TITLE	BASE PLATE FOR TABLA	
PRIORITY NA		

DESIGN NUMBER	252035		
CLASS	15-07		
1)LG ELECTRONICS INC. 20 YEOUIDO - DONG, YEONGDEUNGPO - GU, SEOUL 150 - 721, REPUBLIC OF KOREA A CORPORATION INCORPORATED UNDER THE LAWS OF THE REPUBLIC OF KOREA			
DATE OF REGISTRATION	04/03/2013		
TITLE	LIGHTING FOR REFRIGERATOR		
PRIORITY			
PRIORITY NUMBER	DATE	COUNTRY	
30-2012-0043465	10/09/2012	REPUBLIC OF KOREA	
PRIORITY NA			

DESIGN NUMBER	251955	
CLASS	06-03	
1)GODREJ & BOYCE MFG. CO. LTD., AN INDIAN COMPANY INCORPORATED UNDER THE COMPANIES ACT, 1913, OF GODREJ INTERIO, PLANT 4, PIROJSHANAGER, VIKHROLI (WEST), MUMBAI-400079, INDIA		
DATE OF REGISTRATION	01/03/2013	
TITLE	DESK	
PRIORITY NA		

DESIGN NUMBER	251306	
CLASS	15-09	
1)ENDICO POWER TOOLS (INDIA), AN INDIAN COMPANY, OF 1276/1, STREET NO. 3, SHIMLAPURI, LUDHIANA-141003, PUNJAB, INDIA		
DATE OF REGISTRATION	30/01/2013	
TITLE	BASE PLATE OF ROUTER MACHINE	
PRIORITY NA		

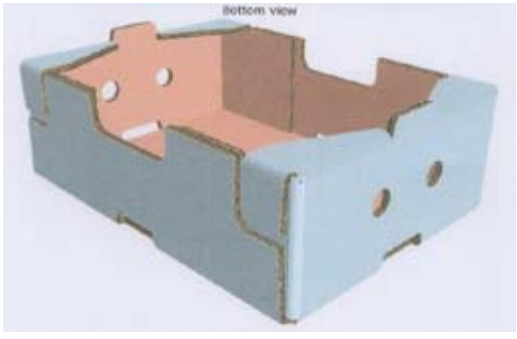
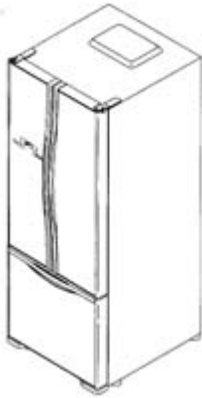
DESIGN NUMBER	251404	
CLASS	02-04	
1)SHREE GANESH INDUSTRIES, T-3/222, MANGOLPURI INDUSTRIAL AREA, PHASE-1, DELHI-110083, INDIA. (AN INDIAN PROPRIETORSHIP FIRM WHOSE PROPRIETOR IS SH. SANJAY BANSAL. AN INDIAN NATIONAL OF THE ABOVE ADDRESS		
DATE OF REGISTRATION	05/02/2013	
TITLE	SHOE	
PRIORITY NA		

DESIGN NUMBER	249709	
CLASS	09-03	
1)ASTRON PACKAGING LIMITED, AN INDIAN COMPANY INCORPORATED UNDER THE COMPANIES ACT, 1956 OF 22-23-34, MAHAGUJARAT INDUSTRIAL ESTATE, SARKHEJ BAVLA HIGHWAY, VILLAGE-MORAIYA, DIST. AHMEDABAD-382210, STATE OF GUJARAT, INDIA		
DATE OF REGISTRATION	26/11/2012	
TITLE	PACKAGING	
PRIORITY NA		
DESIGN NUMBER	251607	
CLASS	15-07	
1)HITACHI APPLIANCES, INC., A JAPANESE CORPORATION OF 16-1, KAIGAN 1-CHOME, MINATO-KU, TOKYO, JAPAN.		
DATE OF REGISTRATION	13/02/2013	
TITLE	REFRIGERATOR	
PRIORITY NA		
DESIGN NUMBER	249886	
CLASS	15-07	
1)GODREJ & BOYCE MFG. CO. LTD., AN INDIAN COMPANY INCORPORATED UNDER THE COMPANIES ACT 1913, OF GODREJ INTERIO, PLANT 4, PIROJSHANAGER, VIKHROLI (WEST), MUMBAI-400079, INDIA		
DATE OF REGISTRATION	04/12/2012	
TITLE	REFRIGERATOR	
PRIORITY NA		

DESIGN NUMBER	250497	
CLASS	24-01	
1)MOHAN SRIVASTAVA (AN INDIAN NATIONAL), TRADING AS M/S. VIKAS SCIENTIFIC INDUSTRIES, WZ-133, RING ROAD, NARAINA, NEW DELHI-110028		
DATE OF REGISTRATION	27/12/2012	
TITLE	GROVED GLASS JOINT WITH RING	
PRIORITY NA		
DESIGN NUMBER	252006	
CLASS	08-06	
1)(1) AJAY VAGHJIBHAI GONDALIYA, (2) VIJAY GONDALIYA, (3) RAJESH BHAYABHAI VAGHASIYA., ALL INDIAN NATIONAL PARTNERS OF M/S. SHREYASH TECHNO CAST., AN INDIAN PARTNERSHIP FIRM., HAVING ITS PRINCIPAL PLACE OF BUSINESS AT, 8'', PARMESHWAR, DHEBAR ROAD (SOUTH), ATIKA IND. AREA, RAJKOT-360002. GUJARAT-INDIA		
DATE OF REGISTRATION	04/03/2013	
TITLE	HANDLE	
PRIORITY NA		
DESIGN NUMBER	252027	
CLASS	17-04	
1)PARMINDER SINGH UBHI, 3357, STREET NO. 4, CHET SINGH NAGAR, GILL ROAD, LUDHIANA-141003 (PUNJAB) INDIA BEING INDIAN NATIONALS OF THE ABOVE ADDRESS		
DATE OF REGISTRATION	04/03/2013	
TITLE	TABLA	
PRIORITY NA		

DESIGN NUMBER	252036	
CLASS	15-07	
1) LG ELECTRONICS INC. 20 YEOUIDO - DONG, YEONGDEUNGPO - GU, SEOUL 150 - 721, REPUBLIC OF KOREA A CORPORATION INCORPORATED UNDER THE LAWS OF THE REPUBLIC OF KOREA		
DATE OF REGISTRATION	04/03/2013	
TITLE	DOOR DISPLAY FOR REFRIGERATOR	
PRIORITY		
PRIORITY NUMBER	DATE	COUNTRY
30-2012-0043467	10/09/2012	REPUBLIC OF KOREA

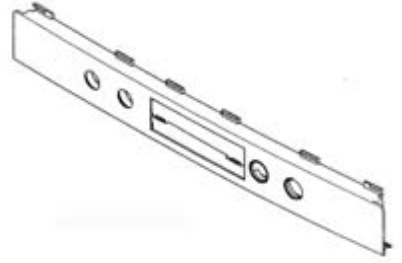



DESIGN NUMBER	252116	
CLASS	02-04	
1) DHEERAJ FOOT CRAFT INDIA PVT. LTD (DULY INCORPORATED UNDER THE PROVISION OF THE COMPANY ACT, 1956) AT 103, SECTOR-3, HSIIDC, KARNAL-132001 (HARYANA), WHOSE DIRECTOR IS MANISH BHANDARI, OF THE ABOVE ADDRESS		
DATE OF REGISTRATION	06/03/2013	
TITLE	SOLE OF FOOTWEAR	
PRIORITY NA		



DESIGN NUMBER	244522	
CLASS	06-01	
1) LALIT HIRANANDANI D 23, INDRASUKH SOCIETY, FOUR BUNGALOWS, ANDHERI (WEST), MUMBAI-400053, MAHARASHTRA, INDIA		
DATE OF REGISTRATION	09/04/2012	
TITLE	CHAIR	
PRIORITY NA		

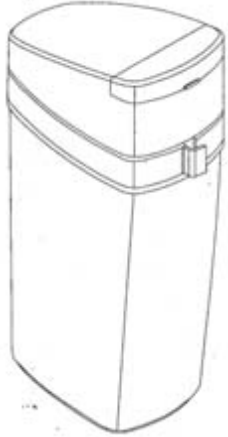





DESIGN NUMBER	247074	
CLASS	09-03	
1)GLAXOSMITHKLINE LLC, A US CORPORATION OF ONE FRANKLIN PLAZA, 200 NORTH 16TH STREET, PHILADELPHIA, PENNSYLVANIA 19102, UNITED STATES OF AMERICA		
DATE OF REGISTRATION	09/08/2012	
TITLE	CONTAINER	
PRIORITY NA		

DESIGN NUMBER	249601	
CLASS	06-13	
1)SARITA HANDA DESIGN WORKS PVT. LTD., AN INDIAN COMPANY OF D-11, DEFENCE COLONY, NEW DELHI-110024, INDIA		
DATE OF REGISTRATION	20/11/2012	
TITLE	PILLOW COVER	
PRIORITY NA		

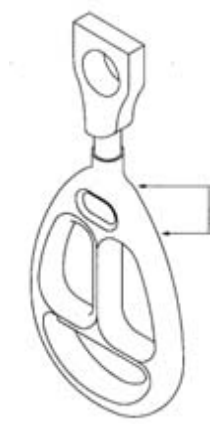
DESIGN NUMBER	251811	
CLASS	09-07	
1)INTERNATIONAL TRADE CORPORATION LIMITED, A BRITISH LIMITED LIABILITY COMPANY IF VICTORIA HOUSE, 49 CLARENDON ROAD, WATFORD, HERTFORDSHIRE, WD17 IHX, UNITED KINGDOM		
DATE OF REGISTRATION	21/02/2013	
TITLE	AEROSOL CAP	
PRIORITY NA		

DESIGN NUMBER	249309	
CLASS	08-06	
1)(1) ARJUN A GOSAI (2) GUNJAN J. KANSAGRA (3) HARDIK S. KAVATHIYA (4) ROHIT V. PATEL (ALL PARTNERS ARE INDIAN NATIONALS) PARTNERS OF COSMOS INDUSTRIES (REGISTERED UNDER THE INDIAN PARTNERSHIP ACT-1932) HAVING PLACE OF BUSINESS AT: PLOT NO. 47, SURVEY NO. 17, OPP: PATEL CLEAN CAST, RANI INDUSTRIAL AREA, B/H PARIN FURNITURE, GONDAL ROAD, VAVADI, RAJKOT-GUJARAT (INDIA)		
DATE OF REGISTRATION	08/11/2012	
TITLE	HANDLE	
PRIORITY NA		
DESIGN NUMBER	251250	
CLASS	12-15	
1)METRO TYRES LIMITED, A COMPANY INCORPORATED UNDER THE INDIAN COMPANIES ACT, 1956, NATIONALITY- INDIAN COMPANY, ADDRESS: B-3 & B-4, SECTOR-58, NOIDA-201301, U.P.		
DATE OF REGISTRATION	28/01/2013	
TITLE	TYRE	
PRIORITY NA		
DESIGN NUMBER	251309	
CLASS	15-09	
1)ENDICO POWER TOOLS (INDIA), AN INDIAN COMPANY, OF 1276/1, STREET NO. 3, SHIMLAPURI, LUDHIANA-141003, PUNJAB, INDIA		
DATE OF REGISTRATION	30/01/2013	
TITLE	ROUTER MACHINE	
PRIORITY NA		

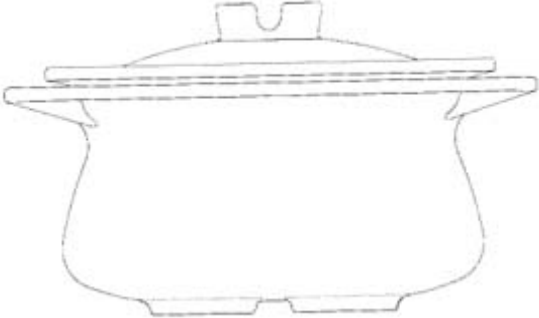

DESIGN NUMBER	249716	
CLASS	09-07	
1)RACHIT ATREY S/O. SH. V. K. ATREY, H NO. 181, AVAS VIKAS COLONY, ROORKEE DIST, HARIDWAR, UTTARAKHAND, INDIA, AN INDIAN NATIONAL, OF THE ABOVE ADDRESS		
DATE OF REGISTRATION	27/11/2012	
TITLE	CAP OF BOTTLE	
PRIORITY NA		
DESIGN NUMBER	246671	
CLASS	08-06	
1)SABIC INNOVATIVE PLASTICS IP B.V., A CORPORATION ORGANIZED AND EXISTING UNDER THE LAWS OF THE NETHERLANDS, OF THE ADDRESS PLASTICSLAAN 1, 4612 PX BERGEN OP ZOOM (NL), NETHERLANDS		
DATE OF REGISTRATION	23/07/2012	
TITLE	GRAB HANDLE	
PRIORITY NA		
DESIGN NUMBER	249875	
CLASS	23-01	
1)RAJNIKANT N. PATEL AN INDIAN NATIONAL SOLE PROPRIETOR OF MONICA POLYMERS AN INDIAN PROPRIETORSHIP FIRM HAVING ITS PRINCIPAL PLACE OF BUSINESS AT C/1, SHAYONA INDUSTRIAL ESTATE, NARODA ROAD, MEMCO CROSS ROAD, MEMCO, AHMEDABAD-380025, GUJARAT-INDIA		
DATE OF REGISTRATION	04/12/2012	
TITLE	TAP	
PRIORITY NA		



DESIGN NUMBER	250003	
CLASS	03-01	
1)PAHWA INTERNATIONAL, AN INDIAN PARTNERSHIP FIRM WHOSE PARTNERS ARE SURINDER SINGH PAHWA, RAWEL KAUR PHAWA, NIRVER SINGH PAHWA AND FATEH SINGH PAHWA AL INDIAN NATIONALS, HAVING ITS ADDRESS AT F-29, OKHLA INDUSTRIAL AREA, PHASE-I, NEW DELHI-110020, INDIA		
DATE OF REGISTRATION	07/12/2012	
TITLE	HAND BAG	
PRIORITY NA		
DESIGN NUMBER	250057	
CLASS	07-02	
1)NIRLEP APPLIANCES LTD., AN INDIAN COMPANY HAVING ADDRESS AS B-5, INDUSTRIAL AREA, MIDC, NEAR STATION ROAD, AURANGABAD-431005, MAHARASHTRA, INDIA		
DATE OF REGISTRATION	10/12/2012	
TITLE	COOKING POT	
PRIORITY NA		
DESIGN NUMBER	250094	
CLASS	08-06	
1)PIYUSHBHAI DILIPBHAI DHOLARIYA (ADULT, & INDIAN NATIONAL) PROPRIETOR OF FLOWTECH INDUSTRIES HAVING PLACE OF BUSINESS AT : 7, PARSANA SOCIETY, 50 FOOT ROAD, NEAR SORATHIYAWADI CIRCLE, RAJKOT-GUJARAT (INDIA)		
DATE OF REGISTRATION	13/12/2012	
TITLE	HANDLE	
PRIORITY NA		

DESIGN NUMBER	250500	
CLASS	24-01	
1)MOHAN SRIVASTAVA (AN INDIAN NATIONAL), TRADING AS M/S. VIKAS SCIENTIFIC INDUSTRIES, WZ-133, RING ROAD, NARAINA, NEW DELHI-110028		
DATE OF REGISTRATION	27/12/2012	
TITLE	GROVED GLASS JOINT WITH RING	
PRIORITY NA		

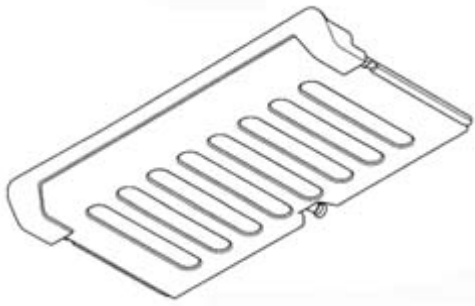
DESIGN NUMBER	250580	
CLASS	09-07	
1)NATIONAL PLASTICS, 91 BASANT AVENUE, AMRITSAR-143011, INDIA, AN INDIAN COMPANY		
DATE OF REGISTRATION	01/01/2013	
TITLE	ACTUATOR OF LOTION PUMP	
PRIORITY NA		

DESIGN NUMBER	250253		
CLASS	24-04		
1)3M INNOVATIVE PROPERTIES COMPANY, A COMPANY INCORPORATED IN THE STATE OF DELAWARE OF 3M CENTER, SAINT PAUL, MINNESOTA 55133-3427, U.S.A.			
DATE OF REGISTRATION	17/12/2012		
TITLE	ORTHOPEDIC PRESSURE DEVICE		
PRIORITY			
PRIORITY NUMBER	DATE	COUNTRY	
29/424,971	18/06/2012	U.S.A.	

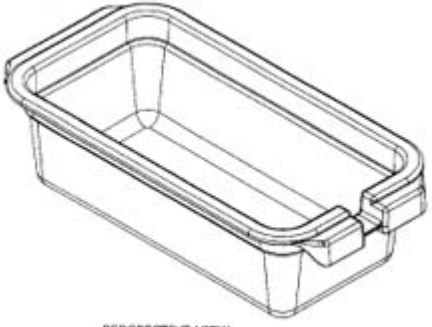
DESIGN NUMBER	252020		
CLASS	12-05		
1)M/S ESCORTS LTD., (A COMPANY INCORPORATED UNDER INDIAN COMPANIES ACT, 1956), 15/5, MATHURA ROAD, FARIDABAD-121003, HARYANA., (INDIA)			
DATE OF REGISTRATION	04/03/2013		
TITLE	ROAD ROLLER		
PRIORITY NA			
DESIGN NUMBER	252039		
CLASS	15-07		
1)LG ELECTRONICS INC. 20 YEOUIDO - DONG, YEONGDEUNGPO - GU, SEOUL 150 - 721, REPUBLIC OF KOREA A CORPORATION INCORPORATED UNDER THE LAWS OF THE REPUBLIC OF KOREA			
DATE OF REGISTRATION	04/03/2013		
TITLE	COLD PROTECTION COVER FOR REFRIGERATOR		
PRIORITY			
PRIORITY NUMBER	DATE	COUNTRY	
30-2012-0043472	10/09/2012	REPUBLIC OF KOREA	
DESIGN NUMBER	252119		
CLASS	08-09		
1)MONGA BROTHERS LIMITED, B-16, PHASE-II, FOCAL POINT, LUDHIANA-141010 (PUNJAB) (INDIA) (AN INDIAN COMPANY DULY REGISTERED UNDER THE COMPANIES ACT, 1956) OF THE ABOVE ADDRESS			
DATE OF REGISTRATION	06/03/2013		
TITLE	HEADS FOR GATES AND GRILLS		
PRIORITY NA			

DESIGN NUMBER	252143		
CLASS	11-01		
1)MEHTA FAMILY TRUST TRADING AS MEHTA JEWELLERY, NO.43, CP RAMASWAMY ROAD, ABHIRAMAPURAM, CHENNAI-600018			
DATE OF REGISTRATION	06/03/2013		
TITLE	EARRING		
PRIORITY NA			
DESIGN NUMBER	249503		
CLASS	07-02		
1)DUKE MANUFACTURING CO., A COMPANY INCORPORATED IN THE STATE OF MISSOURI OF 2305 NORTH BROADWAY, ST. LOUIS, MISSOURI 63102, USA.			
DATE OF REGISTRATION	15/11/2012		
TITLE	PAN		
PRIORITY			
PRIORITY NUMBER	DATE	COUNTRY	
29/422,085	16/05/2012	U.S.A.	
DESIGN NUMBER	251949		
CLASS	28-04		
1)MANSA DEVI BHARADWAJ. (INDIAN NATIONAL) OF ROOM NO. 1, KALAVATI BHAVAN, BABU SHETH CHAWL, SHANTILAL COMPOUND, JAWAHAR NAGAR, KHAR (EAST), MUMBAI-400051, MAHARASHTRA, INDIA.			
DATE OF REGISTRATION	28/02/2013		
TITLE	HAIR BROOCH		
PRIORITY NA			

DESIGN NUMBER	249245	
CLASS	15-05	
1)PRADEEPKUMAR NANDLAL DHOOT, INDIAN NATIONAL OF GANGAPURWALA, 2275 ADAT BAZAR, AHMEDNAGAR-414001, MAHARASHTRA, INDIA		
DATE OF REGISTRATION	05/11/2012	
TITLE	WASHING MACHINE	
PRIORITY NA		

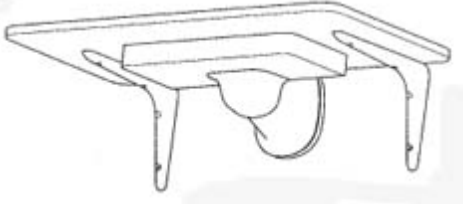
DESIGN NUMBER	251237	
CLASS	14-99	
1)LG ELECTRONICS INC., 20 YEOUIDO-DONG YEONGDEUNGPO - GU SEOUL, 150-721 REPUBLIC OF KOREA, A CORPORATION INCORPORATED UNDER THE LAWS OF THE REPUBLIC OF KOREA		
DATE OF REGISTRATION	28/01/2013	
TITLE	SHELF FOR TV RECEIVER	
PRIORITY		
PRIORITY NUMBER	DATE	COUNTRY
30-2012-0039806	20/08/2012	REPUBLIC OF KOREA

DESIGN NUMBER	251345	
CLASS	09-03	
1)ANSYSO OF 74-75, SECTOR SC, CHANDIGARH 160 018, CHANDIGARH, INDIA, AN INDIAN COMPANY		
DATE OF REGISTRATION	31/01/2013	
TITLE	BOTTLE	
PRIORITY NA		

DESIGN NUMBER	251428	
CLASS	13-03	
1)YAZAKI CORPORATION, A JAPANESE CORPORATION OF 4-28, MITA 1-CHOME, MINATO-KU, TOKYO 108-0073 JAPAN.		
DATE OF REGISTRATION	05/02/2013	
TITLE	FUSE	
PRIORITY		
PRIORITY NUMBER	DATE	COUNTRY
2012-019096	08/08/2012	JAPAN

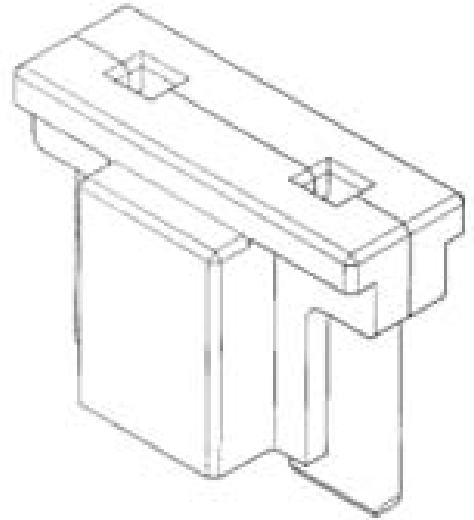

DESIGN NUMBER	249671	
CLASS	26-06	
1)MARCOPOLO S.A., NATIONALITY: BRAZILIAN ADDRESS AT AVENIDA MARCOPOLO, N° 280, CAXIAS DO SUL, RS, BRAZIL		
DATE OF REGISTRATION	23/11/2012	
TITLE	DASHBOARD OF VEHICLE	
PRIORITY NA		

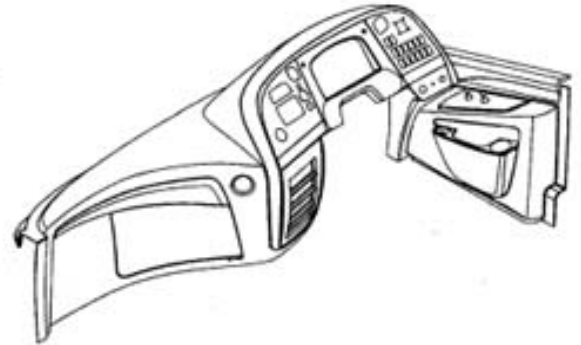

DESIGN NUMBER	249707	
CLASS	09-03	
1)ASTRON PACKAGING LIMITED, AN INDIAN COMPANY INCORPORATED UNDER THE COMPANIES ACT, 1956 OF 22-23-34, MAHAGUJARAT INDUSTRIAL ESTATE, SARKHEJ BAVLA HIGHWAY, VILLAGE-MORAIYA, DIST. AHMEDABAD-382210, STATE OF GUJARAT, INDIA		
DATE OF REGISTRATION	26/11/2012	
TITLE	PACKAGING	
PRIORITY NA		

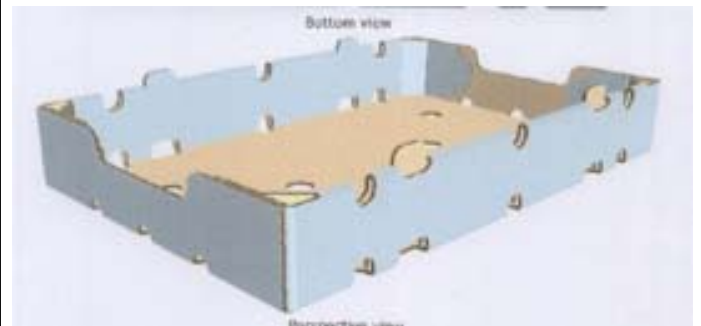

DESIGN NUMBER	249794	
CLASS	12-08	
1)HONDA MOTOR CO., LTD., A CORPORATION OF JAPAN OF 1-1, MINAMI-AOYAMA 2-CHOME, MINATO-KU, TOKYO, 107-8556 JAPAN		
DATE OF REGISTRATION	30/11/2012	
TITLE	CAR	
PRIORITY		
PRIORITY NUMBER	DATE	COUNTRY
2012-012931	31/05/2012	JAPAN



DESIGN NUMBER	249845	
CLASS	15-03	
1)TRACTORS AND FARM EQUIPMENT LIMITED, COMPANY INCORPORATED UNDER THE COMPANIES ACT, 1956, HAVING ITS REGISTERED OFFICE AT NO. 861, ANNASALAI, CHENNAI-600002, TAMIL NADU, INDIA		
DATE OF REGISTRATION	03/12/2012	
TITLE	HARVESTER	
PRIORITY NA		



DESIGN NUMBER	250006	
CLASS	03-01	
1)PAHWA INTERNATIONAL, AN INDIAN PARTNERSHIP FIRM WHOSE PARTNERS ARE SURINDER SINGH PAHWA, RAWEL KAUR PHAWA, NIRVER SINGH PAHWA AND FATEH SINGH PAHWA AL INDIAN NATIONALS, HAVING ITS ADDRESS AT F-29, OKHLA INDUSTRIAL AREA, PHASE-I, NEW DELHI-110020, INDIA		
DATE OF REGISTRATION	07/12/2012	
TITLE	HAND BAG	
PRIORITY NA		





DESIGN NUMBER	250033		
CLASS	15-09		
1)SANDVIK INTELLECTUAL PROPERTY AB, OF SE-811 81 SANDVIKEN, SWEDEN, A SWEDISH COMPANY.			
DATE OF REGISTRATION	07/12/2012		
TITLE	CRUSHER SUPPORT FRAME		
PRIORITY			
PRIORITY NUMBER	DATE	COUNTRY	
001333801-0001	09/07/2012	OHIM	
DESIGN NUMBER	251039		
CLASS	23-01		
1)HANS GROHE SE, OF AUESTR. 5-9, D-77761 SCHILTACH, GERMANY, A GERMAN COMPANY.			
DATE OF REGISTRATION	18/01/2013		
TITLE	SANITARY FAUCET		
PRIORITY			
PRIORITY NUMBER	DATE	COUNTRY	
001337570-0001	31/07/2012	OHIM	
DESIGN NUMBER	251085		
CLASS	23-01		
1)ASHISHBHAI M. PATEL AN INDIAN NATIONAL SOLE PROPRIETOR OF JAL INDUSTRIES AN INDIAN PROPRIETORSHIP FIRM HAVING ITS PRINCIPAL PLACE OF BUSINESS AT 11, VRUNDAVAN ESTATE, OPP. VIJAY ESTATE, B/H. BHIKSHUK GRUH, ODHAV, AHMEDABAD, GUJARAT-INDIA			
DATE OF REGISTRATION	22/01/2013		
TITLE	WATER FILTER		
PRIORITY NA			

DESIGN NUMBER	251114	
CLASS	08-06	
1)(1) MITESHBHAI B. PIPALIYA (2) HITESHBHAI M. PIPALIYA (3) JIGNESHBHAI B. HIRAPARA ALL INDIAN NATIONAL PARTNERS OF PATEL DIE CASTING AN INDIAN PARTNERSHIP FIRM HAVING ITS PRINCIPAL PLACE OF BUSINESS AT PATELNAGAR-4, OPP. SATYANARAYAN MILL, 80 FEET MAIN ROAD, RAJKOT, GUJARAT-INDIA		
DATE OF REGISTRATION	22/01/2013	
TITLE	HANDLE	
PRIORITY NA		
DESIGN NUMBER	250494	
CLASS	08-06	
1)PIYUSHBHAI DILIPBHAI DHOLARIYA (ADULT, & INDIAN NATIONAL) PROPRIETOR OF FLOWTECH INDUSTRIES HAVING PLACE OF BUSINESS AT : 7, PARSANA SOCIETY, 50 FOOT ROAD, NEAR SORATHIYAWADI CIRCLE, RAJKOT-GUJARAT (INDIA)		
DATE OF REGISTRATION	27/12/2012	
TITLE	HANDLE	
PRIORITY NA		
DESIGN NUMBER	250529	 Perspective view
CLASS	10-04	
1)LARSEN & TOUBRO LIMITED, AN INDIAN COMPANY INCORPORATED UNDER THE COMPANIES ACT, 1956 OF L & T HOUSE, BALLARD ESTATE, MUMBAI 400001, STATE OF MAHARASHTRA, INDIA		
DATE OF REGISTRATION	28/12/2012	
TITLE	ENERGY METER	
PRIORITY NA		

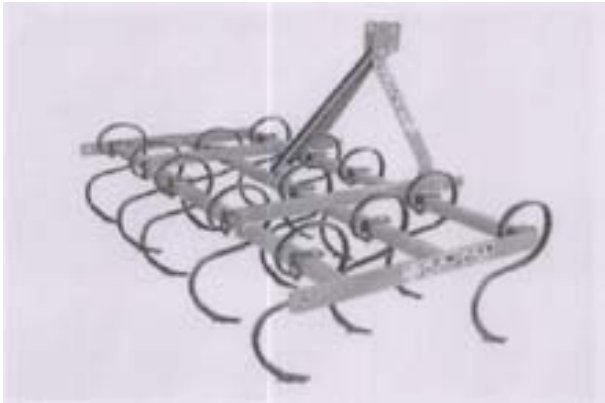
DESIGN NUMBER	248151	
CLASS	12-08	
1)MR. JAGJIT SINGH, AS SOLE PROPRIETOR OF M/S MOTOCRAFT CARRYING ON ITS BUSINESS AT 39, PRITHVIRAJ MARKET (KHAN MARKET), NEW DELHI-110003		
DATE OF REGISTRATION	26/09/2012	
TITLE	CAR	
PRIORITY NA		

DESIGN NUMBER	250341	
CLASS	15-03	
1)RAJPAL AGRICULTURAL MACHINERY PVT. LTD. PLOT NO. 182, SECTOR-3, HSIIDC, KARNAL-132001, HARYANA		
DATE OF REGISTRATION	20/12/2012	
TITLE	TILLER	
PRIORITY NA		

DESIGN NUMBER	252024	
CLASS	13-03	
1)RAVAL BHUPENDRA KANTILAL, ADULT, AN INDIAN NATIONAL, HAVING HIS ADDRESS AT, ANANDNAGAR, BLOCK NO. 22, FLAT NO. 262, SECOND FLOOR, OPP: SAMARPAN HOSPITAL, NR. NILKANTH CINEMA, RAJKOT-360002, GUJARAT STATE, INDIA		
DATE OF REGISTRATION	04/03/2013	
TITLE	ELECTRIC PIN	
PRIORITY NA		

DESIGN NUMBER	252034		
CLASS	15-07		
1) LG ELECTRONICS INC. 20 YEOUIDO - DONG, YEONGDEUNGPO - GU, SEOUL 150 - 721, REPUBLIC OF KOREA A CORPORATION INCORPORATED UNDER THE LAWS OF THE REPUBLIC OF KOREA			
DATE OF REGISTRATION	04/03/2013		
TITLE	DOOR BASKET FOR REFRIGERATOR		
PRIORITY			
PRIORITY NUMBER	DATE	COUNTRY	
30-2012-0043462	10/09/2012	REPUBLIC OF KOREA	
DESIGN NUMBER	252043		
CLASS	10-05		
1) BHARAT HEAVY ELECTRICALS LIMITED, WITH ONE OF ITS REGIONAL OFFICES AT REGIONAL OPERATIONS DIVISION (ROD), PLOT NO. 9/1, DJ BLOCK, 3RD FLOOR, KARUNAMOYEE, SLAT LAKE CITY, KOLKATA-700091, HAVING ITS REGISTERED OFFICE AT BHEL HOUSE SIRI FORT, NEW DELHI-110049, INDIA, AN INDIAN COMPANY			
DATE OF REGISTRATION	04/03/2013		
TITLE	COUPLER FOR FLAME DETECTION SYSTEM		
PRIORITY NA			
DESIGN NUMBER	249625		
CLASS	09-03		
1) ITC LIMITED, AN INDIAN COMPANY WITHIN THE MEANING OF THE COMPANIES ACT, 1956 OF VIRGINIA HOUSE, 37, J. L. NEHRU ROAD, KOLKATA - 700071, WEST BENGAL, INDIA			
DATE OF REGISTRATION	21/11/2012		
TITLE	CIGARETTE PACK		
PRIORITY NA			

DESIGN NUMBER	251760	
CLASS	08-01	
1)ROBERT BOSCH GMBH, A GERMAN COMPANY OF POSTFACH 30 02 20, 70442 STUTTGART, DE, GERMANY		
DATE OF REGISTRATION	19/02/2013	
TITLE	ROTARY HAMMER	
PRIORITY		
PRIORITY NUMBER	DATE	COUNTRY
002118661	15/10/2012	OHIM

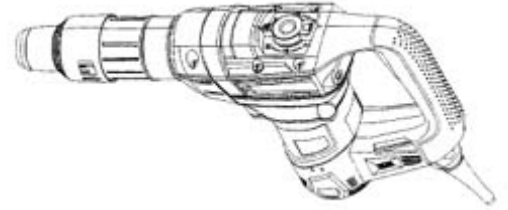

DESIGN NUMBER	251843	
CLASS	21-02	
1)SOCCER INTERNATIONAL PRIVATE LIMITED, AN INDIAN COMPANY, BASTI, SHEIKH ROAD, JALANDHAR-144002, PUNJAB, INDIA		
DATE OF REGISTRATION	22/02/2013	
TITLE	BLADDER FOR BALL	
PRIORITY NA		

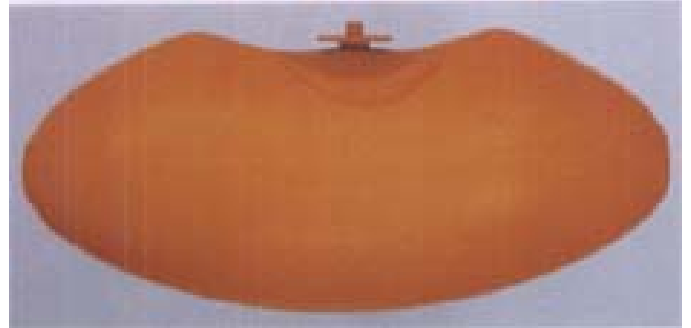

DESIGN NUMBER	246429	
CLASS	23-04	
1)GREE ELECTRIC APPLIANCES, INC. OF ZHUHAI, A COMPANY DULY ORGANIZED AND EXISTING UNDER THE LAWS OF P.R. CHINA OF QIANSHAN JINJI WEST ROAD, ZHUHAI CITY, GUANGDONG, P.R. CHINA 519070		
DATE OF REGISTRATION	09/07/2012	
TITLE	AIR CONDITIONER	
PRIORITY NA		





DESIGN NUMBER	249272		
CLASS	06-04		
1)PANKILBHAI R. MAKADIA., INDIAN NATIONALITY, SOLE PROPRIETOR OF M/S. MOHIT METAL, INDIAN NATIONALITY, HAVING ADDRESS AT 7, AJI VASAHAH, OPP. KAMANI FOUNDRY, RAJKOT-360003, GUJARAT STATE, INDIA			
DATE OF REGISTRATION	06/11/2012		
TITLE	KITCHEN BASKET		
PRIORITY NA			
DESIGN NUMBER	251307		
CLASS	15-09		
1)ENDICO POWER TOOLS (INDIA), AN INDIAN COMPANY, OF 1276/1, STREET NO. 3, SHIMLAPURI, LUDHIANA-141003, PUNJAB, INDIA			
DATE OF REGISTRATION	30/01/2013		
TITLE	BACKALITE PLATE OF ROUTER MACHINE		
PRIORITY NA			
DESIGN NUMBER	251423		
CLASS	23-01		
1)GESSI S.P.A., PARCO GESSI FRAZIONE VINTEBBIO, 13037 SERRAVALLE SESIA (VERCELLI), ITALY, AN ITALIAN JOINT STOCK COMPANY			
DATE OF REGISTRATION	05/02/2013		
TITLE	FAUCET		
PRIORITY			
PRIORITY NUMBER	DATE	COUNTRY	
MI2012O000117	06/08/2012	ITALY	

DESIGN NUMBER	250000	
CLASS	03-01	
1)PAHWA INTERNATIONAL, AN INDIAN PARTNERSHIP FIRM WHOSE PARTNERS ARE SURINDER SINGH PAHWA, RAWEL KAUR PHAWA, NIRVER SINGH PAHWA AND FATEH SINGH PAHWA AL INDIAN NATIONALS, HAVING ITS ADDRESS AT F-29, OKHLA INDUSTRIAL AREA, PHASE-I, NEW DELHI-110020, INDIA		
DATE OF REGISTRATION	07/12/2012	
TITLE	HAND BAG	
PRIORITY NA		

DESIGN NUMBER	250013	
CLASS	03-01	
1)PAHWA INTERNATIONAL, AN INDIAN PARTNERSHIP FIRM WHOSE PARTNERS ARE SURINDER SINGH PAHWA, RAWEL KAUR PHAWA, NIRVER SINGH PAHWA AND FATEH SINGH PAHWA AL INDIAN NATIONALS, HAVING ITS ADDRESS AT F-29, OKHLA INDUSTRIAL AREA, PHASE-I, NEW DELHI-110020, INDIA		
DATE OF REGISTRATION	07/12/2012	
TITLE	PURSE	
PRIORITY NA		

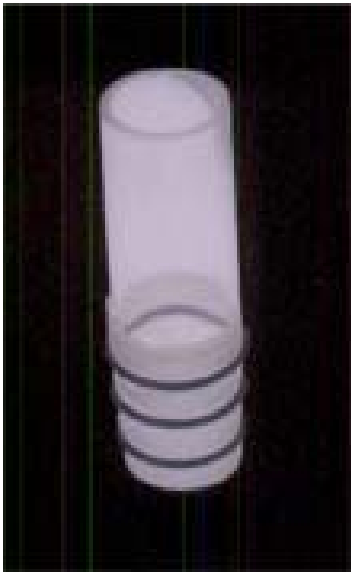

DESIGN NUMBER	252360	
CLASS	09-01	
1)PARIS ELYSEES INDIA PVT. LTD. IT IS INDIAN PRIVATE LIMITED COMPANY AT- A-135, HIRAWALA RIICO INDUSTRIAL AREA, AGRA ROAD, KANOTA-303012, JAIPUR (RAJ.) NATIONALITY-INDIAN		
DATE OF REGISTRATION	15/03/2013	
TITLE	BOTTLE	
PRIORITY NA		

DESIGN NUMBER	250498	
CLASS	24-01	
1) MOHAN SRIVASTAVA (AN INDIAN NATIONAL), TRADING AS M/S. VIKAS SCIENTIFIC INDUSTRIES, WZ-133, RING ROAD, NARAINA, NEW DELHI-110028.		
DATE OF REGISTRATION	27/12/2012	
TITLE	GROVED GLASS JOINT WITH RING	
PRIORITY NA		

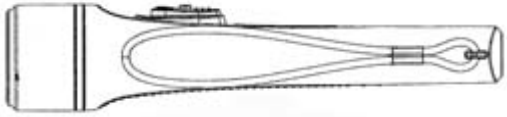
DESIGN NUMBER	250903	
CLASS	08-06	
1)(1) GOVINDBHAI MULJIBHAI BHOOT (2) DINESHBHAI MAGANBHAI CHORATIYA (BOTH PARTNERS ARE INDIAN NATIONAL) PARTNER OF SOMNATH METAL (INDIAN PARTNERSHIP FIRM) HAVING PLACE OF BUSINESS AT : 6, PATEL NAGAR, NR. BHALADA INDUSTRIES, 80 FEET ROAD, SORATHIAWADI, RAJKOT-360001 - GUJARAT (INDIA)		
DATE OF REGISTRATION	10/01/2013	
TITLE	HANDLE	
PRIORITY NA		

DESIGN NUMBER	250989	
CLASS	26-02	
1) EVEREADY INDUSTRIES INDIA LTD. 1, MIDDLETON STREET, KOLKATA - 700071, WEST BENGAL, INDIA, AN INDIAN COMPANY		
DATE OF REGISTRATION	15/01/2013	
TITLE	TORCH	
PRIORITY NA		

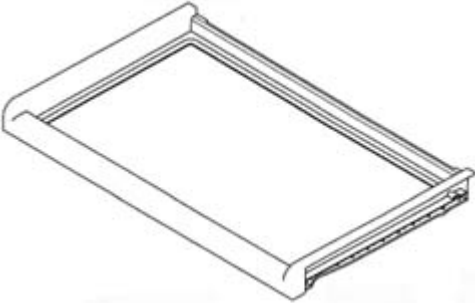
DESIGN NUMBER	250140		
CLASS	13-02		
1)YAZAKI CORPORATION, A JAPANESE CORPORATION OF 4-28, MITA 1-CHOME, MINATO-KU, TOKYO 108-0073, JAPAN			
DATE OF REGISTRATION	13/12/2012		
TITLE	BATTERY COVER		
PRIORITY			
PRIORITY NUMBER	DATE	COUNTRY	
2012-014026	13/06/2012	JAPAN	
DESIGN NUMBER	250243		
CLASS	09-01		
1)M/S HOMELINE PRODUCTS, AN INDIAN PARTNERSHIP FIRM, HAVING ITS PRINCIPAL PLACE OF BUSINESS AT B-106, VIRWANI INDUSTRIAL ESTATE, GOREGAON(EAST), MUMBAI 400063, MAHARASHTRA, INDIA AND WHOSE PARTNERS ARE (1) MR. KANAK M. NIRMAL, (2) MR. RAJESH M. NIRMAL, (3) MR. BHARAT J. NIRMAL, (4) MR. KETAN M. NIRMAL, (5) MR. MUKUNDRAI G. NIRMAL, (6) MRS. RITA K. NIRMAL, (7) MRS. ALPA R. NIRMAL, (8) MRS. CHANDAN B. NIRMAL, (9) MRS. CHANDNI K. NIRMAL			
DATE OF REGISTRATION	17/12/2012		
TITLE	BOTTLE		
PRIORITY NA			
DESIGN NUMBER	252010		
CLASS	08-08		
1)SURESHBHAI RATNABHAI UNDHAL AND KANTIBHAI MOHANBHAI PIPARIYA BOTH INDIAN NATIONAL PARTNER OF S. K. ENTERPRISE AN INDIAN PARTNERSHIP FIRM HAVING ITS PRINCIPAL PLACE OF BUSINESS AT SHRI HARI INDUSTRIAL ZONE, STREET NO. 10, OPP. KHODIYAR HOTEL, NEAR HANUMAN MANDIR, AJI RING ROAD, RAJKOT, GUJARAT-INDIA.			
DATE OF REGISTRATION	04/03/2013		
TITLE	CURTAIN BRACKET		
PRIORITY NA			

DESIGN NUMBER	252028		
CLASS	17-04		
1) PARMINDER SINGH UBHI, 3357, STREET NO. 4, CHET SINGH NAGAR, GILL ROAD, LUDHIANA-141003 (PUNJAB) INDIA BEING INDIAN NATIONALS OF THE ABOVE ADDRESS			
DATE OF REGISTRATION	04/03/2013		
TITLE	SCALE CHANGER FOR TABLA		
PRIORITY NA			
DESIGN NUMBER	252037		
CLASS	15-07		
1) LG ELECTRONICS INC. 20 YEOUIDO - DONG, YEONGDEUNGPO - GU, SEOUL 150 - 721, REPUBLIC OF KOREA A CORPORATION INCORPORATED UNDER THE LAWS OF THE REPUBLIC OF KOREA			
DATE OF REGISTRATION	04/03/2013		
TITLE	SHELF FOR REFRIGERATOR		
PRIORITY			
PRIORITY NUMBER	DATE	COUNTRY	
30-2012-0043469	10/09/2012	REPUBLIC OF KOREA	
PRIORITY NA			
DESIGN NUMBER	252140		
CLASS	12-16		
1) MINDA INDUSTRIES LIMITED., AN INDIAN COMPANY OF VILL. NAWADA FATEPUR, P.O. SIKANDERPUR BADDA, MANESAR, DISTT. GURGAON, HARYANA-122004, INDIA			
DATE OF REGISTRATION	06/03/2013		
TITLE	HANDLE BAR SWITCH FOR VEHICLE		
PRIORITY NA			

DESIGN NUMBER	248466	
CLASS	08-06	
1)SANVI ENTERPRISE., NATIONAL HIGH WAY 8-B, OPP. PARIN FURNITURE, KOTHARIYA SOLVENT AREA, NEAR DHOKIYA MOTORS, KOTHARIYA, DIST: RAJKOT- 360004, GUJARAT, INDIA, INDIAN COMPANY.		
DATE OF REGISTRATION	04/10/2012	
TITLE	CABINATE KNOB	
PRIORITY NA		
DESIGN NUMBER	247395	
CLASS	08-08	
1)DMS ARCHITECTURAL PRODUCTS, PLOT NO.6, SERVEY NO. 20, EVEREST INDUSTRIAL AREA, NR. PERFECT (TATA), SHOWROOM, NATIONAL HIGHWAY NO.8B, VAVDI- RAJKOT, GUJARAT, INDIA, PIN CODE NO.360004		
DATE OF REGISTRATION	28/08/2012	
TITLE	CURTAIN BLIND	
PRIORITY NA		