

INTRODUCTION

In view of the recent amendment made in the Designs (Amendment) Rules, 2008 with effect from 17/06/2008, Publication of the matter relating to Designs is being published in the Official Journal of The Patent Office. This Journal is being published on weekly basis on every Friday covering the various proceedings on Designs as required according to the provisions of under Rule 22, 25, 27 and 39 of the Design (Amendment) Rules, 2008. All the enquiries on this Official Journal and other information as required by the public should be addressed to the Controller General of Patents, Designs & Trade Marks. Suggestions and comments are requested from all quarters so that the content can be enriched.

COPYRIGHT PUBLICATION

SL NO	CASE NUMBERS	RENEWED ON
1.	180830	20.09.2013
2.	180831	20.09.2013
3.	180832	20.09.2013
4.	183044	24.09.2013
5.	183045	24.09.2013
6.	190195	24.09.2013
7.	190207	24.09.2013
8.	192512	16.09.2013
9.	203381	20.09.2013
10.	205484	20.09.2013
11.	205485	20.09.2013
12.	205486	20.09.2013
13.	205487	20.09.2013
14.	205488	20.09.2013
15.	205490	20.09.2013
16.	209228	20.09.2013
17.	215261	20.09.2013
18.	221634	20.09.2013
19.	237538	20.09.2013
20.	239241	20.09.2013
21.	244081	20.09.2013

REGISTRATION OF DESIGNS

The following designs have been registered. They are now open for public inspection. In the following each entry the Date of Registration is shown. The Priority Number, Priority Date and Priority Country are also shown

DESIGN NUMBER	253157	
CLASS	09-01	
1)M/S. AISHWARYA ELECTRICALS PVT. LTD. (A COMPANY DULY INCORPORATED UNDER THE INDIAN COMPANIES ACT, 1956), F 1/C, SITE NO. 1, PANKI INDUSTRIAL AREA, KANPUR (U.P.)		
DATE OF REGISTRATION	15/04/2013	
TITLE	CONTAINER	
PRIORITY NA		
DESIGN NUMBER	253190	
CLASS	23-01	
1)RAJHANS CHEMICALS & PLASTIC INDUSTRIES, B-70/76, DSIDC INDUSTRIAL AREA, LAWRENCE ROAD, DELHI-110035, INDIA. (AN INDIAN PARTNERSHIP FIRM WHOSE PARTNERS ARE :- SH. SANJEEV JAIN AND SMT. SHAKUNTLA DEVI JAIN AN INDIAN NATIONAL OF THE ABOVE ADDRESS		
DATE OF REGISTRATION	16/04/2013	
TITLE	WATER TAP	
PRIORITY NA		
DESIGN NUMBER	250309	
CLASS	24-02	
1)AGATSA SOFTWARE PRIVATE LIMITED C 203 KRISHNA APRA RESIDENCE, SECTOR 61, BEHIND SAI MAHAL, NOIDA, U.P.-201301, INDIA, AN INDIAN COMPANY		
DATE OF REGISTRATION	19/12/2012	
TITLE	ECG MEASURING BELT	
PRIORITY NA		

DESIGN NUMBER	252639	
CLASS	08-06	
1)(1) PARESHBHAI V. BHALIYA (2) CHANDRIKABEN P. BHALIYA (3) RAJESH O. KOTADIA (4) GHANSHYAM O. KOTADIA ALL INDIAN NATIONAL PARTNERS OF MARUTI METALS AN INDIAN PARTNERSHIP FIRM HAVING ITS PRINCIPAL PLACE OF BUSINESS AT SOMNATH ESTATE, SHOP NO. 3, NEAR DWARKADHISH ESTATE, VIRANI AGHAT, DHEBAR ROAD(SOUTH), RAJKOT-2, GUJARAT-INDIA		
DATE OF REGISTRATION	25/03/2013	
TITLE	HANDLE	
PRIORITY NA		

DESIGN NUMBER	251252	
CLASS	06-11	
1)WILLIAM GOODACRE & SONS INDIA PVT. LTD., A COMPANY DULY REGISTERED UNDER THE COMPANIES ACT, 1956, HAVING ADDRESS AT XVIII/1146 REVI KARUNAKARAN ROAD, ALLEPPEY, KERALA-688012		
DATE OF REGISTRATION	28/01/2013	
TITLE	FLOOR MAT	
PRIORITY NA		

DESIGN NUMBER	251364		
CLASS	28-02		
1)ELC MANAGEMENT LLC, A DELAWARE CORPORATION, HAVING AN OFFICE AT 155 PINELAWN ROAD, SUITE 345 SOUTH, MELVILLE, NY 11747, USA			
DATE OF REGISTRATION	01/02/2013		
TITLE	COSMETIC CONTAINER		
PRIORITY			
PRIORITY NUMBER	DATE	COUNTRY	
29/428,671	02/08/2012	U.S.A.	

DESIGN NUMBER	252917	
CLASS	23-99	
1)MAINSTREAM TRADELINK PRIVATE LIMITED, AN INDIAN COMPANY REGISTERED UNDER COMPANIES ACT, 1956 OF 126, BIRESH PALLY (NORTH), MADHYAMGRAM, KOLKATA-700129		
DATE OF REGISTRATION	05/04/2013	
TITLE	COOKING GAS SAVING APPARATUS	
PRIORITY NA		
DESIGN NUMBER	252958	
CLASS	12-16	
1)RING PLUS AQUA LTD., HAVING ADDRESS AT- A-16/17, STICE, AT POST. MUSALGAON, TAL. SINNAR, DIST. NASHIK-422112, STATE-MAHARASHTRA, INDIA AND PERFECT POLYMERS HAVING ADDRESS AT PLOT NO G-1302, ROAD H, KISHAN GATE MAIN ROAD, METODA G.I.D.C., RAJKOT-360021, GUJARAT, INDIA		
DATE OF REGISTRATION	08/04/2013	
TITLE	SEALING DEVICE FOR SHAFT BEARINGS USED IN VEHICLES	
PRIORITY NA		
DESIGN NUMBER	252977	
CLASS	28-03	
1)B. R. PLASTICS, AN INDIAN PARTNERSHIP FIRM, WHOSE OFFICE AT 59, 3RD BHOIWADA, BHULESHWAR, MUMBAI-400002, MAHARASHTRA, INDIA AND FACTORY AT 314, A TO Z INDUSTRIAL ESTATE, 3RD FLOOR, G. KADAM MARG, MUMBAI-400013, MAHARASHTRA, INDIA, WHOSE PARTNERS ARE SURENDRA RAMANLAL SHAH, RAJESH RAMANLAL SHAH, UDAY RAMANLAL SHAH AND PARAG SURENDRA SHAH, ALL INDIANS AND ALL BEING PARTNERS AND OF ABOVE ADDRESS		
DATE OF REGISTRATION	09/04/2013	
TITLE	COMB	
PRIORITY NA		

DESIGN NUMBER	250762	
CLASS	21-01	
1)MAN TRUCK & BUS AG, A GERMAN COMPANY OF DACHAUER STR. 667, 80995 MÜNICH, GERMANY		
DATE OF REGISTRATION	04/01/2013	
TITLE	DRIVER'S CAB OF A TOY UTILITY VEHICLE	
PRIORITY		
PRIORITY NUMBER	DATE	COUNTRY
001335236	04/07/2012	OHIM

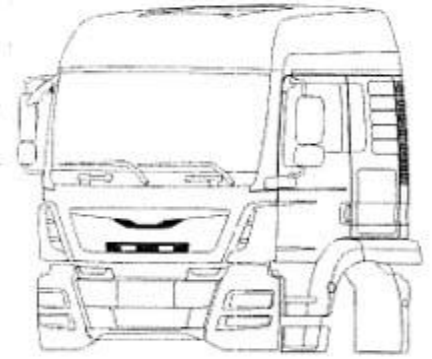

DESIGN NUMBER	250776	
CLASS	21-01	
1)MAN TRUCK & BUS AG, A GERMAN COMPANY OF DACHAUER STR. 667, 80995 MÜNICH, GERMANY		
DATE OF REGISTRATION	04/01/2013	
TITLE	DRIVER'S CAB OF A TOY UTILITY VEHICLE	
PRIORITY		
PRIORITY NUMBER	DATE	COUNTRY
001335236	04/07/2012	OHIM



DESIGN NUMBER	250797	
CLASS	21-01	
1)MAN TRUCK & BUS AG, A GERMAN COMPANY OF DACHAUER STR. 667, 80995 MUNICH, GERMANY		
DATE OF REGISTRATION	04/01/2013	
TITLE	DRIVER'S CAB OF A TOY UTILITY VEHICLE	
PRIORITY		
PRIORITY NUMBER	DATE	COUNTRY
001335236	04/07/2012	OHIM



DESIGN NUMBER	251594	
CLASS	13-99	
1)D. LIGHT DESIGN, INC., CLIFTON HOUSE, 75 FORT STREET, GRAND CAYMAN, CAYMAN ISLANDS, KY 1-1108, USA		
DATE OF REGISTRATION	12/02/2013	
TITLE	CASING FOR A PORTABLE SOLAR PANEL	
PRIORITY		
PRIORITY NUMBER	DATE	COUNTRY
29/430,009	20/08/2012	U.S.A.



DESIGN NUMBER	251624	
CLASS	25-02	
1)SYNERGY THRISLINGTON, A 1, PHASE-1, INDUSTRIAL AREA, MOHALI-160055 (PUNJAB) INDIA AN INDIAN PROPRIETORSHIP FIRM WHOSE PROPRIETOR IS :- HARPAL SINGH BEING INDIAN NATIONALS OF THE ABOVE ADDRESS		
DATE OF REGISTRATION	14/02/2013	
TITLE	PREFABRICATED BUILDING PART	
PRIORITY NA		



DESIGN NUMBER	253178	
CLASS	12-05	
1)M/S ESCORTS LTD., (A COMPANY INCORPORATED UNDER INDIAN COMPANIES ACT, 1956), 15/5, MATHURA ROAD, FARIDABAD-121003, HARYANA., (INDIA)		
DATE OF REGISTRATION	16/04/2013	
TITLE	CRANE	
PRIORITY NA		



DESIGN NUMBER	253280	
CLASS	23-04	
1)MITSUBISHI ELECTRIC CORPORATION, A JAPANESE COMPANY ORGANIZED AND EXISTING UNDER THE LAWS OF JAPAN, MANUFACTURERS AND MERCHANTS, OF THE ADDRESS 7-3, MARUNOUCHI 2-CHOME, CHIYODA-KU, TOKYO 100-8310, JAPAN		
DATE OF REGISTRATION	22/04/2013	
TITLE	FAN	
PRIORITY		
PRIORITY NUMBER	DATE	COUNTRY
2012-026934	06/11/2012	JAPAN

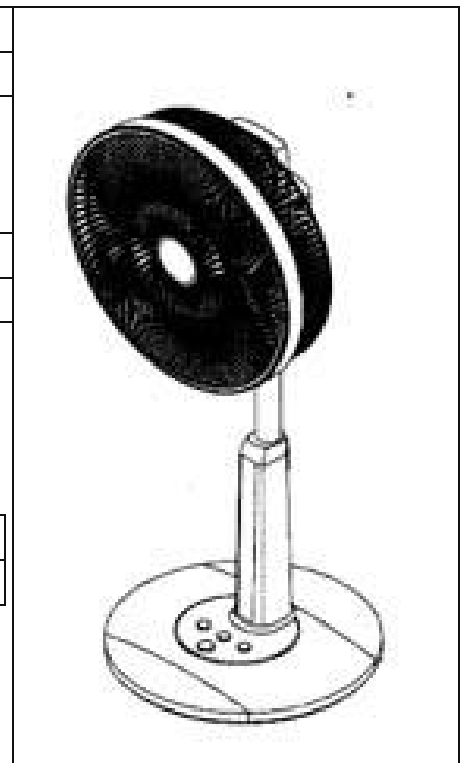

DESIGN NUMBER	253370	
CLASS	12-16	
1)NABTESCO AUTOMOTIVE CORPORATION, A CORPORATION ORGANIZED AND EXISTING UNDER THE LAWS OF JAPAN, OF 7-9, HIRAKAWA-CHO 2-CHOME, CHIYODA-KU, TOKYO 102-0093, JAPAN		
DATE OF REGISTRATION	23/04/2013	
TITLE	BRAKE CHAMBER FOR VEHICLES	
PRIORITY		
PRIORITY NUMBER	DATE	COUNTRY
2012-025971	25/10/2012	JAPAN

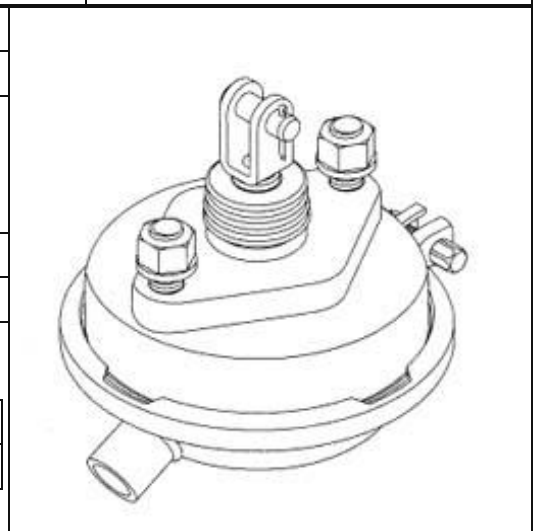

DESIGN NUMBER	250326	
CLASS	21-01	
1)INNOVATION FIRST, INC. ADDRESS AT 1519 INTERSTATE 30 WEST GREENVILLE, TEXAS 75402, UNITED STATES OF AMERICA		
DATE OF REGISTRATION	19/12/2012	
TITLE	TOY	
PRIORITY		
PRIORITY NUMBER	DATE	COUNTRY
29/426,832	11/07/2012	U.S.A.



DESIGN NUMBER	252460	
CLASS	13-02	
1)CROMPTON GREAVES LIMITED, (AN INDIAN COMPANY), AVANTHA HOUSE, 6TH FLOOR, DR. ANNIE BESANT ROAD, WORLI, MUMBAI-400030, MAHARASHTRA, INDIA		
DATE OF REGISTRATION	20/03/2013	
TITLE	CURRENT TRANSFORMER	
PRIORITY NA		
DESIGN NUMBER	252640	
CLASS	08-07	
1)(1) GULAMHUSSAIN MOHAMMED ESMAIL KERIWALA, (2) TEHSEEN ASAD KAGDI, (3) MOHMMED FAZLURREHMAN KAGDI., ALL INDIAN NATIONAL DIRECTORS OF AIRA EURO AUTOMATION PVT. LTD., A COMPANY INCORPORATED UNDER THE COMPANIES ACT, 1956., HAVING ITS PRINCIPAL PLACE OF BUSINESS AT, PLOT NO. 124, AIRA ESTATE, B/H. SECURITY ESTATE, NR. KASHIRAM TEXTILE MILLS, NAROL ROAD, AHMEDABAD-382405. GUJARAT-INDIA		
DATE OF REGISTRATION	25/03/2013	
TITLE	JACKET HEAD BUTTERFLY VALVE	
PRIORITY NA		
DESIGN NUMBER	251253	
CLASS	06-11	
1)WILLIAM GOODACRE & SONS INDIA PVT. LTD., A COMPANY DULY REGISTERED UNDER THE COMPANIES ACT, 1956, HAVING ADDRESS AT XVIII/1146 REVI KARUNAKARAN ROAD, ALLEPPEY, KERALA-688012		
DATE OF REGISTRATION	28/01/2013	
TITLE	FLOOR MAT	
PRIORITY NA		

DESIGN NUMBER	253026		
CLASS	05-05		
1)M/S. BIBA APPARELS PRIVATE LIMITED, AN INDIAN PRIVATE LIMITED COMPANY INCORPORATED UNDER THE PROVISION OF THE COMPANIES ACT, 1956, AND HAVING ITS'S REGISTERED OFFICE AT RELIABLE HOUSE, SITUATED AT HANUMAN SILK MILL COMPOUND, KANJURMARG (WEST), OPP. HUMA MALL, MUMBAI-400 078 MAHARASHTRA, INDIA.			
DATE OF REGISTRATION	11/04/2013		
TITLE	TEXTILE FABRIC		
PRIORITY NA			
DESIGN NUMBER	252235		
CLASS	09-01		
1)MR. SACHIN SACHDEV MRS. MANASI SACHDEV AND MR. RAVI CHAWLA ALL PARTNERS OF NAYASA MULTIPLAST BEING A PARTNERSHIP CONCERN DULY REGISTERED UNDER THE PARTNERSHIP ACT, 1932 HAVING ITS ADDRESS AT PLOT NOS. 224, 225, 227 AND 228, VILLAGE BELA BATHRI, TAHASIL HAROLI, DISTRICT UNA-732141, HIMACHAL PRADESH			
DATE OF REGISTRATION	08/03/2013		
TITLE	CAN		
PRIORITY NA			
DESIGN NUMBER	250763		
CLASS	21-01		
1)MAN TRUCK & BUS AG, A GERMAN COMPANY OF DACHAUER STR. 667, 80995 MÜNICH, GERMANY			
DATE OF REGISTRATION	04/01/2013		
TITLE	DRIVER'S CAB OF A TOY UTILITY VEHICLE		
PRIORITY			
PRIORITY NUMBER	DATE	COUNTRY	
001335236	04/07/2012	OHIM	

DESIGN NUMBER	250788	
CLASS	21-01	
1)MAN TRUCK & BUS AG, A GERMAN COMPANY OF DACHAUER STR. 667, 80995 MUNICH, GERMANY		
DATE OF REGISTRATION	04/01/2013	
TITLE	DRIVER'S CAB OF A TOY UTILITY VEHICLE	
PRIORITY		
PRIORITY NUMBER	DATE	COUNTRY
001335236	04/07/2012	OHIM



DESIGN NUMBER	252838	
CLASS	10-04	
1)FREEMANS MEASURES PVT. LTD, AN INDIAN COMPANY, G. T. ROAD, JUGIANA, LUDHIANA - 141117, PUNJAB, INDIA, AN INDIAN COMPANY		
DATE OF REGISTRATION	03/04/2013	
TITLE	MEASURING TAPE	
PRIORITY NA		



DESIGN NUMBER	250528	
CLASS	13-03	
1)LARSEN & TOUBRO LIMITED, AN INDIAN COMPANY INCORPORATED UNDER THE COMPANIES ACT, 1956 OF L & T HOUSE, BALLARD ESTATE, MUMBAI 400001, STATE OF MAHARASHTRA, INDIA		
DATE OF REGISTRATION	28/12/2012	
TITLE	MOULDED CASE CIRCUIT BREAKER	
PRIORITY NA		



DESIGN NUMBER	253371	
CLASS	12-16	
1)NABTESCO AUTOMOTIVE CORPORATION, A CORPORATION ORGANIZED AND EXISTING UNDER THE LAWS OF JAPAN, OF 7-9, HIRAKAWA-CHO 2-CHOME, CHIYODA-KU, TOKYO 102-0093, JAPAN 7-9, HIRAKAWA-CHO 2-CHOME, CHIYODA-KU, TOKYO 102-0093, JAPAN		
DATE OF REGISTRATION	23/04/2013	
TITLE	BRAKE CHAMBER FOR VEHICLES	
PRIORITY		
PRIORITY NUMBER	DATE	COUNTRY
2012-027247	08/11/2012	JAPAN

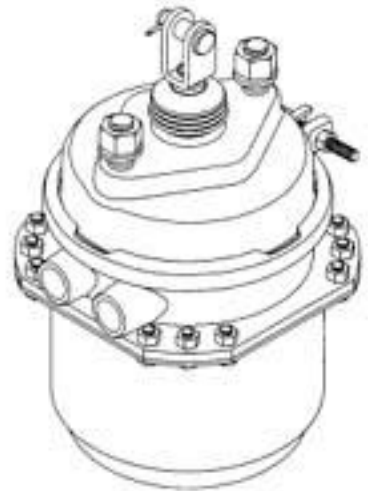

DESIGN NUMBER	251814	
CLASS	24-04	
1)TEIKOKU SEIYAKU CO., LTD., 567, SANBONMATSU, HIGASHIKAGAWA-SHI, KAGAWA 7692695, JAPAN, A JAPANESE COMPANY		
DATE OF REGISTRATION	21/02/2013	
TITLE	ADHESIVE SKIN PATCH	
PRIORITY		
PRIORITY NUMBER	DATE	COUNTRY
2012-020294	24/08/2012	JAPAN

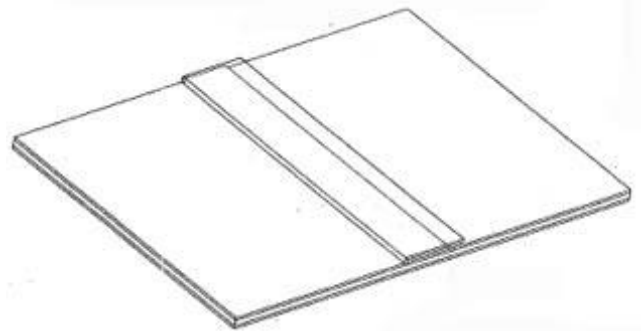

DESIGN NUMBER	251866	
CLASS	03-01	
1)A.K.M. PATHARIA., 288, ABDUL REHMAN STREET, MUMBAI-400003. STATE OF MAHARASHTRA, (INDIA), AN INDIAN PROPRIETORSHIP FIRM, WHOSE PROPRIETOR IS MOHAMMED ABEDALI PATHARIA INDIAN NATIONALS., OF ABOVE ADDRESS		
DATE OF REGISTRATION	26/02/2013	
TITLE	TOOL BOX	



PRIORITY NA		
--------------------	--	--

DESIGN NUMBER	250206	
CLASS	23-01	
1)EUREKA FORBES LTD. A COMPANY INCORPORATED UNDER INDIAN COMPANIES ACT, 1956, HAVING PLACE OF BUSINESS AT NO. 42, P-3/C, MUNESHWARA LAYOUT, HARALUKUNTE, KUDLU, BANGALORE 78		
DATE OF REGISTRATION	17/12/2012	
TITLE	WATER PURIFIER	
PRIORITY NA		
DESIGN NUMBER	253406	
CLASS	12-11	
1)SHRI ROHIT GHANSHYAMDAS CHANDNANI, AN INDIAN NATIONAL AND AN INDIAN RESIDENT OF C/O VEGAS ENGINEERING, OPPOSITE BALAJI CLEAN CAST, BEHIND SATYANARAYAN WEIGH BRIDGE, GONDAL ROAD, VAVDI, RAJKOT-360001, GUJARAT		
DATE OF REGISTRATION	25/04/2013	
TITLE	CYCLE	
PRIORITY NA		
DESIGN NUMBER	253426	
CLASS	09-01	
1)GODREJ CONSUMER PRODUCTS LIMITED, AN INDIAN COMPANY HAVING ITS REGISTERED OFFICE AT PIROJSHANAGAR, EASTERN EXPRESS HIGHWAY, VIKHROLI, MUMBAI-400079, STATE OF MAHARASHTRA, INDIA		
DATE OF REGISTRATION	25/04/2013	
TITLE	BOTTLE	
PRIORITY NA		

DESIGN NUMBER	248112	
CLASS	07-02	
1)NARENDIRAN REDDY SIMMACHALAM 12/379, 13TH CROSS STREET, PHASE-1, SATHUVACHARI, VELLORE-632009		
DATE OF REGISTRATION	24/09/2012	
TITLE	COOKING PLATE	
PRIORITY NA		

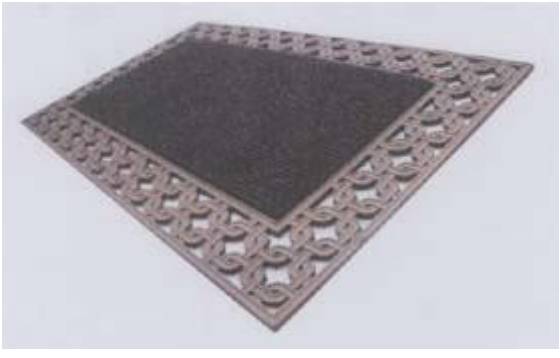
DESIGN NUMBER	251255	
CLASS	06-11	
1)WILLIAM GOODACRE & SONS INDIA PVT. LTD., A COMPANY DULY REGISTERED UNDER THE COMPANIES ACT, 1956, HAVING ADDRESS AT XVIII/1146 REVI KARUNAKARAN ROAD, ALLEPPEY, KERALA-688012		
DATE OF REGISTRATION	28/01/2013	
TITLE	FLOOR MAT	
PRIORITY NA		

DESIGN NUMBER	251392	
CLASS	12-11	
1)HONDA MOTOR CO., LTD., A JAPANESE CORPORATION, OF 1-1, MINAMI-AOYAMA 2-CHOME, MINATO-KU, TOKYO, JAPAN		
DATE OF REGISTRATION	04/02/2013	
TITLE	MOTORCYCLE	
PRIORITY		
PRIORITY NUMBER	DATE	COUNTRY
2012-018876	07/08/2012	JAPAN

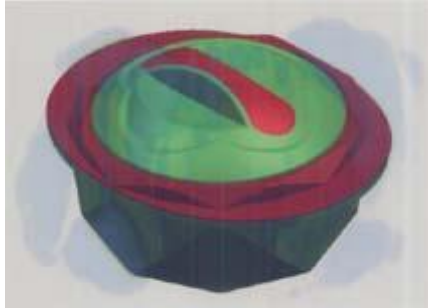
DESIGN NUMBER	253037		
CLASS	05-05		
1)M/S. BIBA APPARELS PRIVATE LIMITED, AN INDIAN PRIVATE LIMITED COMPANY INCORPORATED UNDER THE PROVISION OF THE COMPANIES ACT, 1956, AND HAVING ITS'S REGISTERED OFFICE AT RELIABLE HOUSE, SITUATED AT HANUMAN SILK MILL COMPOUND, KANJURMARG (WEST), OPP. HUMA MALL, MUMBAI-400078 MAHARASHTRA, INDIA			
DATE OF REGISTRATION	11/04/2013		
TITLE	TEXTILE FABRIC		
PRIORITY NA			
DESIGN NUMBER	253121		
CLASS	07-02		
1)SUN INTERNATIONAL B-12/13, EVERSHINE INDUSTRIAL ESTATE, CHINCH PADA, WALIV ROAD, VASAI (E), DIST: THANE. STATE OF MAHARASHTRA, (INDIA), AN INDIAN PARTNERSHIP FIRM, WHOSE PARTNERS ARE: (1)RAKESH BHAVARLAL BAFNA (2)SOHANLAL MITHALAL JAIN. INDIAN NATIONALS., OF ABOVE ADDRESS			
DATE OF REGISTRATION	12/04/2013		
TITLE	CASSEROLE		
PRIORITY NA			
DESIGN NUMBER	250764		
CLASS	21-01		
1)MAN TRUCK & BUS AG, A GERMAN COMPANY OF DACHAUER STR. 667, 80995 MÜNICH, GERMANY			
DATE OF REGISTRATION	04/01/2013		
TITLE	DRIVER'S CAB OF A TOY UTILITY VEHICLE		
PRIORITY			
PRIORITY NUMBER	DATE	COUNTRY	
001335236	04/07/2012	OHIM	

DESIGN NUMBER	252685
CLASS	25-01
1)AL AZIZ PLASTICS PRIVATE LIMITED, A PRIVATE LIMITED COMPANY INCORPORATED UNDER THE COMPANIES ACT, 1956, HAVING ITS PRINCIPAL PLACE OF BUSINESS AT AMAR INDUSTRIAL ESTATE, 125, SAKINAKA, MUMBAI-400072	
DATE OF REGISTRATION	26/03/2013
TITLE	PIPE GUARD
PRIORITY NA	

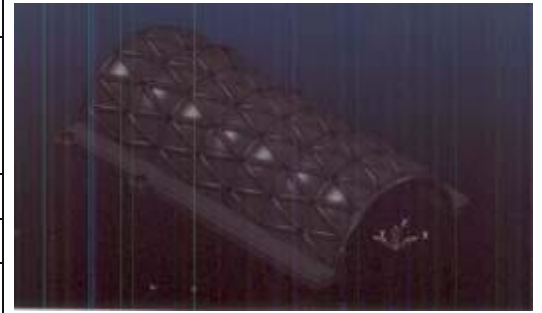

DESIGN NUMBER	252841
CLASS	06-01
1)FORMWAY FURNITURE LIMITED, 43B SEAVIEW ROAD, LOWER HUTT, WELLINGTON 5010, NEW ZEALAND, A NEW ZEALAND COMPANY	
DATE OF REGISTRATION	03/04/2013
TITLE	CHAIR

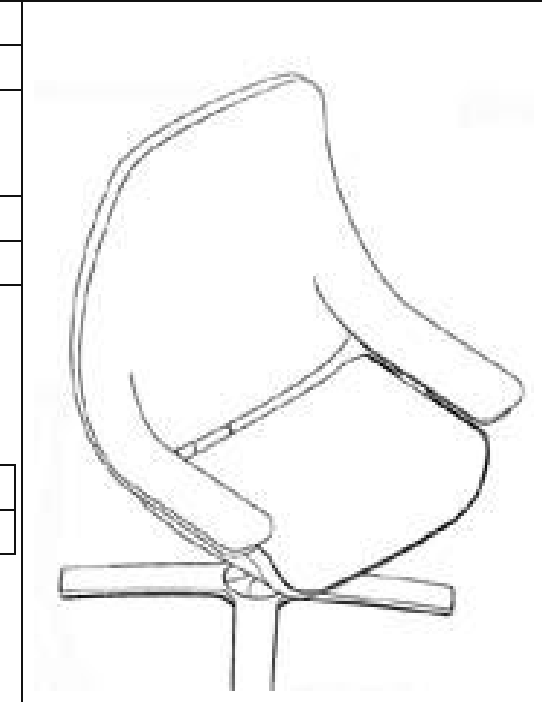

PRIORITY		
PRIORITY NUMBER	DATE	COUNTRY
29/433,784	04/10/2012	U.S.A.

DESIGN NUMBER	252127
CLASS	12-11
1)HONDA MOTOR CO., LTD., A JAPANESE CORPORATION, OF 1-1, MINAMI-AOYAMA 2-CHOME, MINATO-KU, TOKYO, JAPAN	
DATE OF REGISTRATION	06/03/2013
TITLE	MOTORCYCLE



PRIORITY		
PRIORITY NUMBER	DATE	COUNTRY
2012-023586	28/09/2012	JAPAN

DESIGN NUMBER	233930		
CLASS	06-11		
1)M/S COSMIQUE GLOBAL A PARTNERSHIP FIRM REGISTERED UNDER THE INDIAN PARTNERSHIP ACT, HAVING ITS REGISTERED OFFICE AT 191. MAIN FAIZ ROAD, KAROL BAGH, NEW DELHI-110 005, INDIA.			
DATE OF REGISTRATION	14/01/2011		
TITLE	HANDLOOM CROCHET CARPETS		
PRIORITY NA			
DESIGN NUMBER	251549		
CLASS	12-15		
1)COMPAGNIE GENERALE DES ETABLISSEMENTS MICHELIN, A FRENCH COMPANY OF 12 COURS SABLON, FR-63000, CLERMONT-FERRAND, FRANCE, AND MICHELIN RECHERCHE ET TECHNIQUE S.A., A SWISS COMPANY OF ROUTE LOUIS BRAILLE 10-CH-1763, GRANGES-PACCOT, SWITZERLAND			
DATE OF REGISTRATION	11/02/2013		
TITLE	TIRE TREAD		
PRIORITY			
PRIORITY NUMBER	DATE	COUNTRY	
29/429,796	16/08/2012	U.S.A.	
DESIGN NUMBER	251762		
CLASS	24-02		
1)KONINKLIJKE PHILIPS ELECTRONICS N.V., A COMPANY ORGANIZED AND EXISTING UNDER THE LAWS OF THE KINGDOM OF THE NETHERLANDS, RESIDING AT EINDHOVEN, WHOSE POST-OFFICE ADDRESS IS HIGH TECH CAMPUS 5, 5656 AE EINDHOVEN, THE NETHERLANDS			
DATE OF REGISTRATION	19/02/2013		
TITLE	CAP FOR ELECTRIC BREAST PUMP		
PRIORITY			
PRIORITY NUMBER	DATE	COUNTRY	
002091611-0002	23/08/2012	OHIM	

DESIGN NUMBER	226597		
CLASS	14-03		
1)NOKIA CORPORATION KEILALAHDENTIE 4, ESPOO, FIN-02150, FINLAND			
DATE OF REGISTRATION	31/12/2009		
TITLE	HANDSET		
PRIORITY			
PRIORITY NUMBER	DATE	COUNTRY	
29/346020	26/10/2009	U.S.A.	
DESIGN NUMBER	251033		
CLASS	24-99		
1)SPAN BIOTRONICS PRIVATE LIMITED, A COMPANY INCORPORATED UNDER THE LAWS OF INDIA HAVING ITS OFFICE AT 2, VATIKA, 14 BAPISTA ROAD, VILE PARLE (W), MUMBAI-400056, MAHARASHTRA			
DATE OF REGISTRATION	18/01/2013		
TITLE	DISC DISPENSING DEVICE		
PRIORITY NA			
DESIGN NUMBER	252645		
CLASS	12-11		
1)TUBE INVESTMENTS OF INDIA LIMITED, AN INDIAN COMPANY INCORPORATED UNDER THE COMPANIES ACT OF 1956, HAVING ITS PRINCIPAL PLACE OF BUSINESS AT 'DARE HOUSE', 234, N. S. C. BOSE ROAD, CHENNAI - 600001, STATE OF TAMIL NADU, INDIA			
DATE OF REGISTRATION	25/03/2013		
TITLE	BACK REST PAD FOR BICYCLE		
PRIORITY NA			

DESIGN NUMBER	248113	
CLASS	07-02	
1)NARENDIRAN REDDY SIMMACHALAM 12/379, 13TH CROSS STREET, PHASE-1, SATHUVACHARI, VELLORE-632009.		
DATE OF REGISTRATION	24/09/2012	
TITLE	COOKING PLATE	
PRIORITY NA		

DESIGN NUMBER	251378	
CLASS	09-01	
1)M/S. NEST FOODS & BEVERAGES CORPORATION, V/34A, PALLIPURAM, MARAMPILLY, ALUVA, ERNAKULAM DISTRICT, KERALA, INDIA.		
DATE OF REGISTRATION	04/02/2013	
TITLE	BOTTLE	
PRIORITY NA		

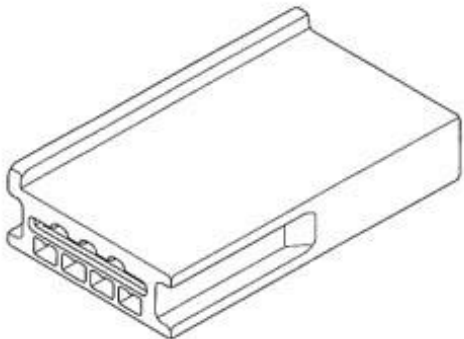
DESIGN NUMBER	252996	
CLASS	13-03	
1)SUMITOMO WIRING SYSTEMS, LTD., A JAPANESE COMPANY, OF 1-14, NISHISUEHIRO-CHO, YOKKAICHI-SHI, MIE-KEN 510-8503, JAPAN		
DATE OF REGISTRATION	10/04/2013	
TITLE	ELECTRICAL CONNECTOR	
PRIORITY		
PRIORITY NUMBER	DATE	COUNTRY
2012-027659	13/11/2012	JAPAN

DESIGN NUMBER	253114	
CLASS	08-06	
1)VIMALBHAI CHANDUBHAI SHINGALA (INDIAN NATIONALS) PROPRIETOR OF ROCK INDUSTRIES (INDIAN PROPRIETORSHIP CONCERN) HAVING PLACE OF BUSINESS AT- B/H. BALAJI PETROL PUMP, 80 FEET ROAD, SORATHIYAWADI, RAJKOT - 360002, GUJARAT (INDIA)		
DATE OF REGISTRATION	12/04/2013	
TITLE	HANDLE	
PRIORITY NA		

DESIGN NUMBER	250848	
CLASS	06-01	
1)ITALICA FURNITURE PRIVATE LIMITED, E-260-261, M I A, UDAIPUR, INDIA, AN INDIAN COMPANY		
DATE OF REGISTRATION	08/01/2013	
TITLE	CHAIR	
PRIORITY NA		

DESIGN NUMBER	250932	
CLASS	09-01	
1)SAVERGLASS, A FRENCH COMPANY OF 3 RUE DE LA GARE, 60960 FEUQUIERES, FRANCE		
DATE OF REGISTRATION	10/01/2013	
TITLE	BOTTLE	
PRIORITY		
PRIORITY NUMBER	DATE	COUNTRY
002095273-0001	31/08/2012	OHIM

DESIGN NUMBER	252424	
CLASS	06-01	
1)STEELCASE INC., 901-44TH STREET, S.E., GRAND RAPIDS, MICHIGAN 49508 UNITED STATES OF AMERICA, NATIONALITY: USA		
DATE OF REGISTRATION	19/03/2013	
TITLE	CHAIR	
PRIORITY		
PRIORITY NUMBER	DATE	COUNTRY
29/432,821	20/09/2012	U.S.A.



DESIGN NUMBER	250771	
CLASS	21-01	
1)MAN TRUCK & BUS AG, A GERMAN COMPANY OF DACHAUER STR. 667, 80995 MUNICH, GERMANY		
DATE OF REGISTRATION	04/01/2013	
TITLE	DRIVER'S CAB OF A TOY UTILITY VEHICLE	
PRIORITY		
PRIORITY NUMBER	DATE	COUNTRY
001335236	04/07/2012	OHIM





DESIGN NUMBER	250792	
CLASS	21-01	
1)MAN TRUCK & BUS AG, A GERMAN COMPANY OF DACHAUER STR. 667, 80995 MUNICH, GERMANY		
DATE OF REGISTRATION	04/01/2013	
TITLE	DRIVER'S CAB OF A TOY UTILITY VEHICLE	
PRIORITY		
PRIORITY NUMBER	DATE	COUNTRY
001335236	04/07/2012	OHIM

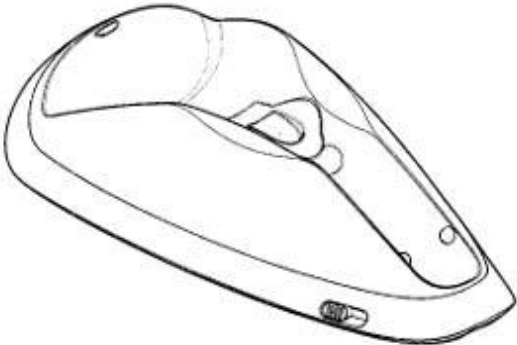

DESIGN NUMBER	252776		
CLASS	15-06		
1)M/S CITIZEN UDYOG, ST. NO. 2, NIRMAL NAGAR, DUGRI ROAD, LUDHIANA-141002 (PUNJAB) INDIA AN INDIAN PROPRIETORSHIP FIRM WHOSE PROPRIETOR IS:- NARESH BEHL BEING INDIAN NATIONALS OF THE ABOVE ADDRESS			
DATE OF REGISTRATION	02/04/2013		
TITLE	SEALING MACHINE FOR BAGS		
PRIORITY NA			
DESIGN NUMBER	252821		
CLASS	09-08		
1)CHEP INDIA PRIVATE LIMITED, AN INDIAN COMPANY, HAVING ITS ADDRESS AT 3RD FLOOR, AVER PLAZA OPP. CITI MALL, NEW LINK RD. ANDHERI(W), MUMBAI 400053, INDIA			
DATE OF REGISTRATION	03/04/2013		
TITLE	PALLET COLLAR		
PRIORITY NA			
DESIGN NUMBER	251473		
CLASS	12-16		
1)HONDA MOTOR CO., LTD., A JAPANESE CORPORATION, OF 1-1, MINAMI-AOYAMA 2-CHOME, MINATO-KU, TOKYO, JAPAN			
DATE OF REGISTRATION	07/02/2013		
TITLE	FRONT SIDE COWL FOR MOTORCYCLE		
PRIORITY			
PRIORITY NUMBER	DATE	COUNTRY	
2012-019521	13/08/2012	JAPAN	

DESIGN NUMBER	253189	
CLASS	23-01	
1)RAJHANS CHEMICALS & PLASTIC INDUSTRIES, B-70/76, DSIDC INDUSTRIAL AREA, LAWRENCE ROAD, DELHI-110035, INDIA. (AN INDIAN PARTNERSHIP FIRM WHOSE PARTNERS ARE :- SH. SANJEEV JAIN AND SMT. SHAKUNTLA DEVI JAIN AN INDIAN NATIONAL OF THE ABOVE ADDRESS		
DATE OF REGISTRATION	16/04/2013	
TITLE	WATER TAP	
PRIORITY NA		

DESIGN NUMBER	251766	
CLASS	07-05	
1)KONINKLIJKE PHILIPS ELECTRONICS N.V., A COMPANY ORGANIZED AND EXISTING UNDER THE LAWS OF THE KINGDOM OF THE NETHERLANDS, RESIDING AT EINDHOVEN, WHOSE POST-OFFICE ADDRESS IS HIGH TECH CAMPUS 5, 5656 AE EINDHOVEN, THE NETHERLANDS		
DATE OF REGISTRATION	19/02/2013	
TITLE	BASE FOR GARMENT STEAMER	
PRIORITY		
PRIORITY NUMBER	DATE	COUNTRY
002091488-0002	23/08/2012	OHIM

DESIGN NUMBER	252472	
CLASS	23-04	
1)CROMPTON GREAVES LIMITED, (AN INDIAN COMPANY), AVANTHA HOUSE, 6TH FLOOR, DR. ANNIE BESANT ROAD, WORLI, MUMBAI-400030, MAHARASHTRA, INDIA		
DATE OF REGISTRATION	20/03/2013	
TITLE	TABLE FAN	
PRIORITY NA		

DESIGN NUMBER	252638	
CLASS	08-06	
1)(1) PARESHBHAI V. BHALIYA (2) CHANDRIKABEN P. BHALIYA (3) RAJESH O. KOTADIA (4) GHANSHYAM O. KOTADIA ALL INDIAN NATIONAL PARTNERS OF MARUTI METALS AN INDIAN PARTNERSHIP FIRM HAVING ITS PRINCIPAL PLACE OF BUSINESS AT SOMNATH ESTATE, SHOP NO. 3, NEAR DWARKADHISH ESTATE, VIRANI AGHAT, DHEBAR ROAD (SOUTH), RAJKOT-2, GUJARAT-INDIA		
DATE OF REGISTRATION	25/03/2013	
TITLE	HANDLE	
PRIORITY NA		

DESIGN NUMBER	251363	
CLASS	09-07	
1)ELC MANAGEMENT LLC, A DELAWARE CORPORATION, HAVING AN OFFICE AT 155 PINELAWN ROAD, SUITE 345 SOUTH, MELVILLE, NY 11747, USA		
DATE OF REGISTRATION	01/02/2013	
TITLE	CAP FOR A COSMETIC CONTAINER	
PRIORITY		
PRIORITY NUMBER	DATE	COUNTRY
29/428,673	02/08/2012	U.S.A.

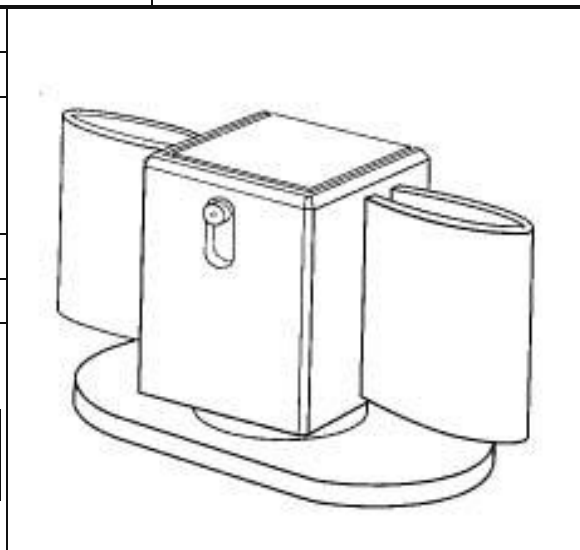

DESIGN NUMBER	252916
CLASS	13-03
1)SHAILESHBHAI G. DALASANIYA AND SHAILESHBHAI B. MENDAPARA BOTH INDIAN NATIONAL PARTNER OF ROYAL PLASTIC AN INDIAN PARTNERSHIP FIRM HAVING ITS PRINCIPAL PLACE OF BUSINESS AT ADDRESS: GOKULDHAM MAIN ROAD, GOKULNAGAR-2, UMIYAJI ESTATE, RAJKOT-360004, GUJARAT-INDIA	
DATE OF REGISTRATION	05/04/2013
TITLE	MODULAR BOX FOR ELECTRICAL INSTALLATION
PRIORITY NA	



DESIGN NUMBER	250761
CLASS	21-01
1)MAN TRUCK & BUS AG, A GERMAN COMPANY OF DACHAUER STR. 667, 80995 MÜNICH, GERMANY	
DATE OF REGISTRATION	04/01/2013
TITLE	DRIVER'S CAB OF A TOY UTILITY VEHICLE

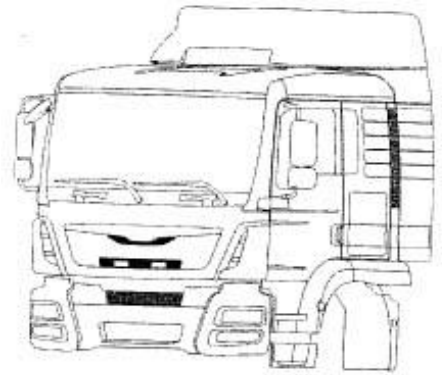

PRIORITY		
PRIORITY NUMBER	DATE	COUNTRY
001335236	04/07/2012	OHIM

DESIGN NUMBER	250775
CLASS	21-01
1)MAN TRUCK & BUS AG, A GERMAN COMPANY OF DACHAUER STR. 667, 80995 MUNICH, GERMANY	
DATE OF REGISTRATION	04/01/2013
TITLE	DRIVERS CAB OF A TOY UTILITY VEHICLE

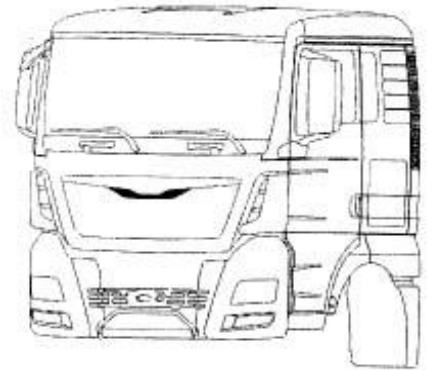

PRIORITY		
PRIORITY NUMBER	DATE	COUNTRY
001335236	04/07/2012	OHIM

DESIGN NUMBER	250796
CLASS	21-01
1)MAN TRUCK & BUS AG, A GERMAN COMPANY OF DACHAUER STR. 667, 80995 MUNICH, GERMANY	
DATE OF REGISTRATION	04/01/2013
TITLE	DRIVER'S CAB OF A TOY UTILITY VEHICLE



PRIORITY		
PRIORITY NUMBER	DATE	COUNTRY
001335236	04/07/2012	OHIM

DESIGN NUMBER	251668	
CLASS	26-05	
1)MA DESIGN INDIA PRIVATE LIMITED, A COMPANY INCORPORATED IN INDIA HAVING ITS PRINCIPAL PLACE OF BUSINESS AT A-41, SECTOR-80, PHASE-II, NOIDA-201305, U.P. INDIA		
DATE OF REGISTRATION	14/02/2013	
TITLE	TABLE LAMP	
PRIORITY NA		

DESIGN NUMBER	251763	
CLASS	24-02	
1)KONINKLIJKE PHILIPS ELECTRONICS N.V., A COMPANY ORGANIZED AND EXISTING UNDER THE LAWS OF THE KINGDOM OF THE NETHERLANDS, RESIDING AT EINDHOVEN, WHOSE POST-OFFICE ADDRESS IS HIGH TECH CAMPUS 5, 5656 AE EINDHOVEN, THE NETHERLANDS		
DATE OF REGISTRATION	19/02/2013	
TITLE	BASE UNIT FOR ELECTRIC BREAST PUMP	
PRIORITY		
PRIORITY NUMBER	DATE	COUNTRY
002091611-0001	23/08/2012	OHIM

DESIGN NUMBER	252468	
CLASS	23-04	
1)CROMPTON GREAVES LIMITED, (AN INDIAN COMPANY), AVANTHA HOUSE, 6TH FLOOR, DR. ANNIE BESANT ROAD, WORLI, MUMBAI-400030, MAHARASHTRA, INDIA		
DATE OF REGISTRATION	20/03/2013	
TITLE	PEDESTAL FAN	
PRIORITY NA		

DESIGN NUMBER	252646	
CLASS	12-11	
1)TUBE INVESTMENTS OF INDIA LIMITED, AN INDIAN COMPANY INCORPORATED UNDER THE COMPANIES ACT OF 1956, HAVING ITS PRINCIPAL PLACE OF BUSINESS AT “DARE HOUSE”, 234, N. S. C. BOSE ROAD, CHENNAI - 600001, STATE OF TAMIL NADU, INDIA		
DATE OF REGISTRATION	25/03/2013	
TITLE	CHAIN COVER FOR BICYCLE	
PRIORITY NA		

DESIGN NUMBER	253429	
CLASS	09-07	
1)K & LAB CO., LTD., 4FL., POLIKEM BLDG., GWANYANG-DONG, 374, SIMIN-DAERO ANYANG SI DONGAN-GU, GYEONGGI-DO, 431-804, REPUBLIC OF KOREA, NATIONALITY: REPUBLIC OF KOREA		
DATE OF REGISTRATION	25/04/2013	
TITLE	LID OF CUP	
PRIORITY		
PRIORITY NUMBER	DATE	COUNTRY
30-2012-0050882	25/10/2012	REPUBLIC OF KOREA

DESIGN NUMBER	253501	
CLASS	12-11	
1)AKHIL INDUSTRIAL CORPORATION OF OFFICE AT:- 8466-B, GURPAL NAGAR, STREET NO. 15, LUDHIANA-141010 (PUNJAB) & ALSO WORKS AT:- EKTA MARKET, PLOT NO. 169, OPPOSITE DHANDARI RAILWAY STATION, DHANDARI KALAN, LUDHIANA-141010 (PUNJAB), INDIA, AN INDIAN PROPRIETORSHIP FIRM WHOSE PROPRIETOR IS SH. CHANDER BHUSAN VERMA		
DATE OF REGISTRATION	29/04/2013	
TITLE	BICYCLE BREAK LEVER	
PRIORITY NA		

DESIGN NUMBER	253134	
CLASS	07-02	
1)EAGLE HOME APPLIANCES PVT. LTD., AN INDIAN COMPANY HAVING ADDRESS FOR SERVICE AT 4TH FLOOR, PARMAR GALLERY, SHIVARKAR ROAD, OPPOSITE PARMAR PARK, WANAWADI, PUNE 411040, MAHARASHTRA, INDIA		
DATE OF REGISTRATION	12/04/2013	
TITLE	PAN	
PRIORITY NA		

DESIGN NUMBER	250937	
CLASS	15-02	
1)EMERSON CLIMATE TECHNOLOGIES (INDIA) LIMITED, A COMPANY INCORPORATED UNDER THE INDIAN COMPANIES ACT, AT PLOT NO. 23, RAJIV GANDHI INFOTECH PARK, PHASE-II, HINJEWADI, PUNE-411057, MAHARASHTRA, INDIA		
DATE OF REGISTRATION	10/01/2013	
TITLE	COMPRESSOR	
PRIORITY NA		

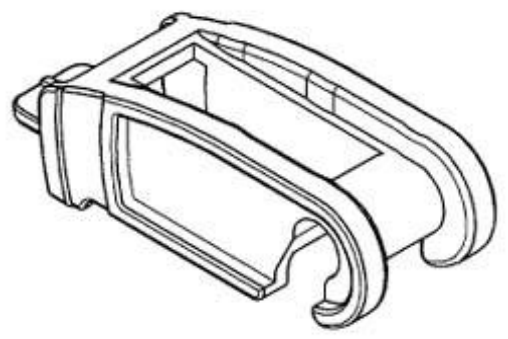
DESIGN NUMBER	252367		
CLASS	12-16		
1)ADM21 CO., LTD. A KOREAN CORPORATION, 607, HAKDANG-RI, CHEONGYANG-EUP, CHEONGYANG-GUN, CHUNGHEONGNAM-DO, REPUBLIC OF KOREA			
DATE OF REGISTRATION	15/03/2013		
TITLE	ARM-BINDING CONNECTOR OF WIPER FOR AUTOMOBILES		
PRIORITY			
PRIORITY NUMBER	DATE	COUNTRY	
30-2012-0049131	16/10/2012	REPUBLIC OF KOREA	

DESIGN NUMBER	250772	
CLASS	21-01	
1)MAN TRUCK & BUS AG, A GERMAN COMPANY OF DACHAUER STR. 667, 80995 MUNICH, GERMANY		
DATE OF REGISTRATION	04/01/2013	
TITLE	DRIVER'S CAB OF A TOY UTILITY VEHICLE	
PRIORITY		
PRIORITY NUMBER	DATE	COUNTRY
001335236	04/07/2012	OHIM



DESIGN NUMBER	253154	
CLASS	08-05	
1)TAIYO ELECTRIC IND. CO., LTD., OF 16-08, YAMATECHO 2-CHOME, FUKUYAMA-SHI, HIROSHIMA-KEN 720-0092, JAPAN		
DATE OF REGISTRATION	15/04/2013	
TITLE	SOLDERING IRON	
PRIORITY		
PRIORITY NUMBER	DATE	COUNTRY
2012-026307	30/10/2012	JAPAN



DESIGN NUMBER	253187	
CLASS	23-01	
1)RAJHANS CHEMICALS & PLASTIC INDUSTRIES, B-70/76, DSIDC INDUSTRIAL AREA, LAWRENCE ROAD, DELHI-110035, INDIA. (AN INDIAN PARTNERSHIP FIRM WHOSE PARTNERS ARE :- SH. SANJEEV JAIN AND SMT. SHAKUNTLA DEVI JAIN AN INDIAN NATIONAL OF THE ABOVE ADDRESS		
DATE OF REGISTRATION	16/04/2013	
TITLE	WATER TAP	
PRIORITY NA		



DESIGN NUMBER	251764	
CLASS	15-05	
1)KONINKLIJKE PHILIPS ELECTRONICS N.V., A COMPANY ORGANIZED AND EXISTING UNDER THE LAWS OF THE KINGDOM OF THE NETHERLANDS, RESIDING AT EINDHOVEN, WHOSE POST-OFFICE ADDRESS IS HIGH TECH CAMPUS 5, 5656 AE EINDHOVEN, THE NETHERLANDS		
DATE OF REGISTRATION	19/02/2013	
TITLE	VACUUM CLEANER	
PRIORITY		
PRIORITY NUMBER	DATE	COUNTRY
002091652-0001	23/08/2012	OHIM

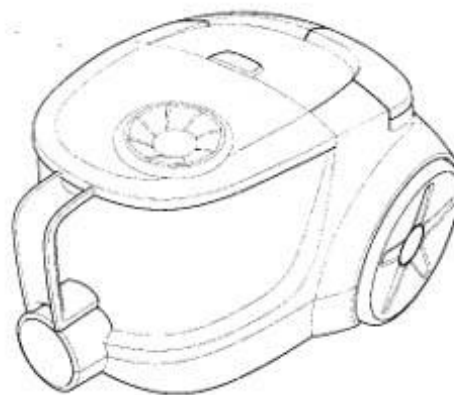



DESIGN NUMBER	251788	
CLASS	02-04	
1)M/S VEEKESY ELASTOMERS PVT LTD, AN INDIAN COMPANY REGISTERED UNDER COMPANIES ACT, 1956, HAVING ITS REGISTERED OFFICE AT DOOR NO. VII/330, NH-17, KOLATHARA P.O, KOZHIKODE, PIN-673655, KERALA, INDIA		
DATE OF REGISTRATION	19/02/2013	
TITLE	FOOTWEAR	
PRIORITY NA		



DESIGN NUMBER	252516	
CLASS	13-03	
1)CROMPTON GREAVES LIMITED, (AN INDIAN COMPANY), AVANTHA HOUSE, 6TH FLOOR, DR. ANNIE BESANT ROAD, WORLI, MUMBAI-400030, MAHARASHTRA, INDIA		
DATE OF REGISTRATION	20/03/2013	
TITLE	PROTECTIVE RELAY	
PRIORITY NA		



DESIGN NUMBER	252914	
CLASS	24-01	
1)MR. SACHIN G. LOKAPURA(INDIA). A PROPRIETORSHIP FIRM AND HAVING ITS PRINCIPAL PLACE OF BUSINESS 5099, NEAR ASHA TALKIES, OPP. OMKAR APPT, SHANIWAR PETH, MIRAJ. DIST-SANGLI MIRAJ- 416410, MAHARASHTRA, INDIA		
DATE OF REGISTRATION	05/04/2013	
TITLE	DISK TYPE SAMPLE HOLDER FOR BACTERIAL MOVEMENT DETECTION	
PRIORITY NA		

DESIGN NUMBER	253055	
CLASS	05-05	
1)M/S. BIBA APPARELS PRIVATE LIMITED, AN INDIAN PRIVATE LIMITED COMPANY INCORPORATED UNDER THE PROVISION OF THE COMPANIES ACT, 1956, AND HAVING ITS'S REGISTERED OFFICE AT RELIABLE HOUSE, SITUATED AT HANUMAN SILK MILL COMPOUND, KANJURMARG (WEST), OPP. HUMA MALL, MUMBAI-400078 MAHARASHTRA, INDIA		
DATE OF REGISTRATION	11/04/2013	
TITLE	TEXTILE FABRIC	
PRIORITY NA		

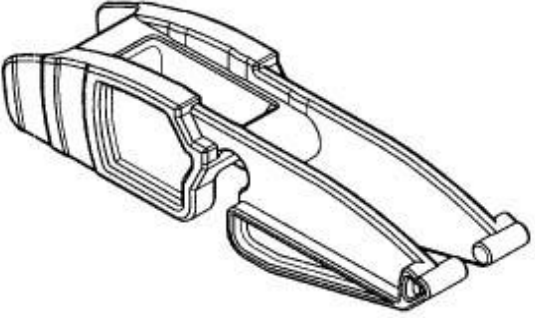
DESIGN NUMBER	252368	
CLASS	12-16	
1)ADM21 CO., LTD. A KOREAN CORPORATION, 607, HAKDANG-RI, CHEONGYANG-EUP, CHEONGYANG-GUN, CHUNGCHEONGNAM-DO, REPUBLIC OF KOREA		
DATE OF REGISTRATION	15/03/2013	
TITLE	ARM-BINDING CONNECTOR OF WIPER FOR AUTOMOBILES	
PRIORITY		
PRIORITY NUMBER	DATE	COUNTRY
30-2012-0049132	16/10/2012	REPUBLIC OF KOREA

DESIGN NUMBER	250759	
CLASS	21-01	
1)MAN TRUCK & BUS AG, A GERMAN COMPANY OF DACHAUER STR. 667, 80995 MUNICH, GERMANY		
DATE OF REGISTRATION	04/01/2013	
TITLE	DRIVER'S CAB OF A TOY UTILITY VEHICLE	
PRIORITY		
PRIORITY NUMBER	DATE	COUNTRY
001335236	04/07/2012	OHIM





DESIGN NUMBER	250773	
CLASS	21-01	
1)MAN TRUCK & BUS AG, A GERMAN COMPANY OF DACHAUER STR. 667, 80995 MUNICH, GERMANY		
DATE OF REGISTRATION	04/01/2013	
TITLE	DRIVER'S CAB OF A TOY UTILITY VEHICLE	
PRIORITY		
PRIORITY NUMBER	DATE	COUNTRY
001335236	04/07/2012	OHIM





DESIGN NUMBER	250794	
CLASS	21-01	
1)MAN TRUCK & BUS AG, A GERMAN COMPANY OF DACHAUER STR. 667, 80995 MUNICH, GERMANY		
DATE OF REGISTRATION	04/01/2013	
TITLE	DRIVER'S CAB OF A TOY UTILITY VEHICLE	
PRIORITY		
PRIORITY NUMBER	DATE	COUNTRY
001335236	04/07/2012	OHIM



DESIGN NUMBER	252762	
CLASS	07-02	
1)KUBER CHAMPALALJI BAMBOLI 3/404, RISHABH MANSION, JAWAHAR NAGAR, S. V. ROAD, GOREGAON (W), MUMBAI-400062. INDIAN NATIONAL STATE OF MAHARASHTRA INDIA, AN INDIAN OF THE ABOVE ADDRESS		
DATE OF REGISTRATION	02/04/2013	
TITLE	CASSEROLE	
PRIORITY NA		

DESIGN NUMBER	251998	
CLASS	12-09	
1)ESCORTS LIMITED, OF 15/5, KM, MATHURA ROAD, FARIDABAD-121003, HARYANA, INDIA, AN INDIAN COMPANY		
DATE OF REGISTRATION	01/03/2013	
TITLE	TRACTOR	
PRIORITY NA		

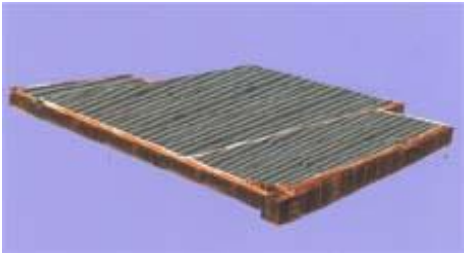
DESIGN NUMBER	251553	
CLASS	09-03	
1)SH. RAKESH KUMAR, C-15, NARESH PARK EXTN., INDUSTRIAL AREA, NANGLOI, NEW DELHI-110041, (INDIA). AN INDIAN NATIONAL OF THE ABOVE ADDRESS		
DATE OF REGISTRATION	11/02/2013	
TITLE	CONTAINER	
PRIORITY NA		

DESIGN NUMBER	251631	
CLASS	25-02	
1)SYNERGY THRISLINGTON, A 1, PHASE-1, INDUSTRIAL AREA, MOHALI-160055 (PUNJAB) INDIA AN INDIAN PROPRIETORSHIP FIRM WHOSE PROPRIETOR IS :- HARPAL SINGH BEING INDIAN NATIONALS OF THE ABOVE ADDRESS		
DATE OF REGISTRATION	14/02/2013	
TITLE	FLOOR SLAB FOR BUILDING	
PRIORITY NA		
DESIGN NUMBER	253188	
CLASS	23-01	
1)RAJHANS CHEMICALS & PLASTIC INDUSTRIES, B-70/76, DSIDC INDUSTRIAL AREA, LAWRENCE ROAD, DELHI-110035, INDIA. (AN INDIAN PARTNERSHIP FIRM WHOSE PARTNERS ARE :- SH. SANJEEV JAIN AND SMT. SHAKUNTLA DEVI JAIN AN INDIAN NATIONAL OF THE ABOVE ADDRESS		
DATE OF REGISTRATION	16/04/2013	
TITLE	WATER TAP	
PRIORITY NA		
DESIGN NUMBER	253239	
CLASS	23-02	
1)JOYFUL PLASTICS PRIVATE LIMITED, A COMPANY REGISTERED IN INDIA, HAVING ITS REGISTERED OFFICE AT 20, A/F, NEW EMPIRE INDUSTRIAL ESTATE, KONDIVITA ROAD, J.B. NAGAR, ANDHERI (E), MUMBAI-400059, STATE OF MAHARASHTRA, INDIA, OF ABOVE ADDRESS		
DATE OF REGISTRATION	18/04/2013	
TITLE	POTTY	
PRIORITY NA		

DESIGN NUMBER	253345	
CLASS	23-03	
1)BHUTORIA, SUNIL; AN INDIAN NATIONAL, OF THE ADDRESS: AL-6, SHALIMAR BAGH, NEW DELHI-110088		
DATE OF REGISTRATION	23/04/2013	
TITLE	OVEN	
PRIORITY NA		

DESIGN NUMBER	251765	
CLASS	07-05	
1)KONINKLIJKE PHILIPS ELECTRONICS N.V., A COMPANY ORGANIZED AND EXISTING UNDER THE LAWS OF THE KINGDOM OF THE NETHERLANDS, RESIDING AT EINDHOVEN, WHOSE POST-OFFICE ADDRESS IS HIGH TECH CAMPUS 5, 5656 AE EINDHOVEN, THE NETHERLANDS		
DATE OF REGISTRATION	19/02/2013	
TITLE	BASE FOR GARMENT STEAMER	
PRIORITY		
PRIORITY NUMBER	DATE	COUNTRY
002091488-0001	23/08/2012	OHIM

DESIGN NUMBER	251225	
CLASS	09-99	
1)MIKAEL NILSSON, SWEDISH NATIONAL, C/O. SMART GROUP AB, SKRAPAN 1890, SE-722 10 VÄSTERÅS, SWEDEN		
DATE OF REGISTRATION	28/01/2013	
TITLE	SHAKER	
PRIORITY NA		

DESIGN NUMBER	252471	
CLASS	23-04	
1)CROMPTON GREAVES LIMITED, (AN INDIAN COMPANY), AVANTHA HOUSE, 6TH FLOOR, DR. ANNIE BESANT ROAD, WORLI, MUMBAI-400030, MAHARASHTRA, INDIA		
DATE OF REGISTRATION	20/03/2013	
TITLE	WALL FAN	
PRIORITY NA		
DESIGN NUMBER	252540	
CLASS	26-03	
1)CROMPTON GREAVES LIMITED, (AN INDIAN COMPANY), AVANTHA HOUSE, 6TH FLOOR, DR. ANNIE BESANT ROAD, WORLI, MUMBAI- 400030, MAHARASHTRA, INDIA		
DATE OF REGISTRATION	20/03/2013	
TITLE	LIGHTING FIXTURE	
PRIORITY NA		
DESIGN NUMBER	252637	
CLASS	08-06	
1)AMITBHAI M. CHOVIYA AND ASHISHBHAI G. GADHIYA BOTH INDIAN NATIONAL PARTNERS OF FORAM SALES CORPORATION AN INDIAN PARTNERSHIP FIRM HAVING ITS PRINCIPAL PLACE OF BUSINESS AT PLOT NO. 7, PATEL IND. AREA, OPP. RIDDHI SIDDHI PARK, NEAR SANDHIYA POOL, (KOTHARIYA), RAJKOT, GUJARAT-INDIA		
DATE OF REGISTRATION	25/03/2013	
TITLE	HANDLE	
PRIORITY NA		

DESIGN NUMBER	252653
CLASS	23-02
1)SITHARA PLASTICS PVT LTD, IV/259 A, MALAYATTOOR P.O., NEELISHWARAM, ERNAKULAM-683587, KERALA STATE, INDIA, A COMPANY INCORPORATED UNDER THE COMPANIES ACT, 1956	
DATE OF REGISTRATION	25/03/2013
TITLE	SEPTIC TANK
PRIORITY NA	



DESIGN NUMBER	253436
CLASS	08-07
1)SHARAD AGARWAL (AN INDIAN NATIONAL) M/S. SHRI JI INDUSTRIES, MEENOCHALL MIG-68, VIKAS NAGAR, AGRA ROAD, ALIGARH-202001 (U.P.)	
DATE OF REGISTRATION	26/04/2013
TITLE	INTERLOCK
PRIORITY NA	



DESIGN NUMBER	252954
CLASS	08-05
1)DIVYA INDUSTRIES, WZ-27/B, 1ST FLOOR, GALI NO. 4, RAMGARH COLONY, BASAI DARAPUR, NEW DELHI- 110015, INDIA. (AN INDIAN PROPRIETORSHIP FIRM WHOSE PROPRIETOR IS :- SH. SAMEER GUPTA. AN INDIAN NATIONAL OF THE ABOVE ADDRESS	
DATE OF REGISTRATION	08/04/2013
TITLE	WELDING HOLDER
PRIORITY NA	

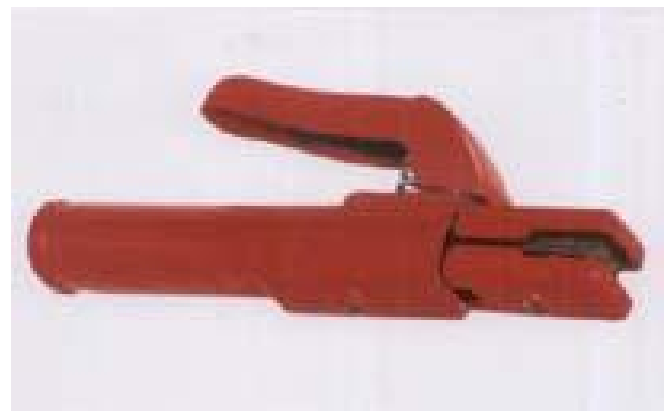

DESIGN NUMBER	250760	
CLASS	21-01	
1)MAN TRUCK & BUS AG, A GERMAN COMPANY OF DACHAUER STR. 667, 80995 MUNICH, GERMANY		
DATE OF REGISTRATION	04/01/2013	
TITLE	DRIVER'S CAB OF A TOY UTILITY VEHICLE	
PRIORITY		
PRIORITY NUMBER	DATE	COUNTRY
001335236	04/07/2012	OHIM

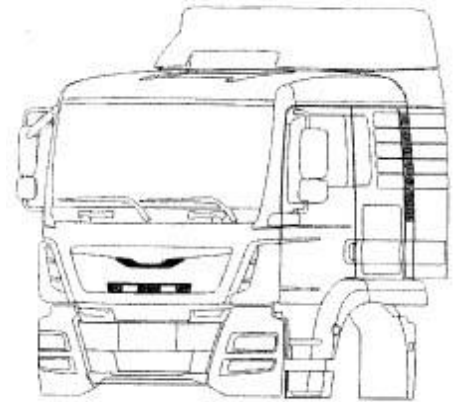

DESIGN NUMBER	250774	
CLASS	21-01	
1)MAN TRUCK & BUS AG, A GERMAN COMPANY OF DACHAUER STR. 667, 80995 MUNICH, GERMANY		
DATE OF REGISTRATION	04/01/2013	
TITLE	DRIVER'S CAB OF A TOY UTILITY VEHICLE	
PRIORITY		
PRIORITY NUMBER	DATE	COUNTRY
001335236	04/07/2012	OHIM



DESIGN NUMBER	250795	
CLASS	21-01	
1)MAN TRUCK & BUS AG, A GERMAN COMPANY OF DACHAUER STR. 667, 80995 MUNICH, GERMANY		
DATE OF REGISTRATION	04/01/2013	
TITLE	DRIVER'S CAB OF A TOY UTILITY VEHICLE	
PRIORITY		
PRIORITY NUMBER	DATE	COUNTRY
001335236	04/07/2012	OHIM

