

***CONTINUED FROM PART- 1***

**INTRODUCTION**

In view of the recent amendment made in the Designs (Amendment) Rules, 2008 with effect from 17/06/2008, Publication of the matter relating to Designs is being published in the Official Journal of The Patent Office. This Journal is being published on weekly basis on every Friday covering the various proceedings on Designs as required according to the provisions of under Rule 22, 25, 27 and 39 of the Design (Amendment) Rules, 2008. All the enquiries on this Official Journal and other information as required by the public should be addressed to the Controller General of Patents, Designs & Trade Marks. Suggestions and comments are requested from all quarters so that the content can be enriched.

## **COPYRIGHT PUBLICATION**

<b>SL NO</b>	<b>CASE NUMBERS</b>	<b>RENEWED ON</b>
<b>1.</b>	<b>181605</b>	<b>30.09.2013</b>
<b>2.</b>	<b>185857</b>	<b>03.10.2013</b>
<b>3.</b>	<b>186357</b>	<b>03.10.2013</b>
<b>4.</b>	<b>189196</b>	<b>30.09.2013</b>
<b>5.</b>	<b>189245</b>	<b>30.09.2013</b>
<b>6.</b>	<b>189564</b>	<b>30.09.2013</b>
<b>7.</b>	<b>189934</b>	<b>30.09.2013</b>
<b>8.</b>	<b>189935</b>	<b>30.09.2013</b>
<b>9.</b>	<b>194132</b>	<b>07.10.2013</b>
<b>10.</b>	<b>202561</b>	<b>03.10.2013</b>
<b>11.</b>	<b>195318</b>	<b>01.10.2013</b>
<b>12.</b>	<b>195272</b>	<b>01.10.2013</b>
<b>13.</b>	<b>193615</b>	<b>24.09.2013</b>
<b>14.</b>	<b>192610</b>	<b>24.09.2013</b>
<b>15.</b>	<b>191927</b>	<b>25.09.2013</b>



**THE DESIGNS ACT, 2000**  
**SECTION 30**  
**DESIGN ASSIGNMENT**

The Design stands in the name of Kraft Foods Global Brands LLC registered under the Designs Act, 2000 has been assigned in the Register of Designs in the name as follows:-



<b>Design No.</b>	<b>Class</b>	<b>Name</b>
231746, 231744, 231743, 231741, 231742, 231736, 231738, 231737, 231739, 231735, 231740, 231734	09-01	KRAFT FOODS GROUP BRANDS LLC OF THREE LAKES DRIVE, NORTHFIELD, ILLINOIS, 60093, USA, A US CORPORATION

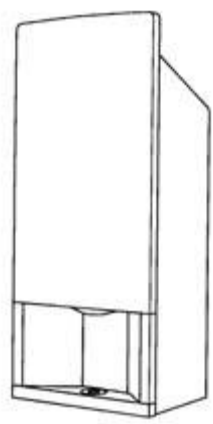

## REGISTRATION OF DESIGNS

The following designs have been registered. They are now open for public inspection. In the following each entry the Date of Registration is shown. The Priority Number, Priority Date and Priority Country are also shown

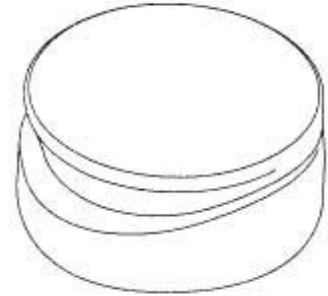
<b>DESIGN NUMBER</b>	250265		
<b>CLASS</b>	13-03		
<b>1) LARSEN &amp; TOUBRO LIMITED, AN INDIAN COMPANY INCORPORATED UNDER THE COMPANIES ACT, 1956 OF</b> L & T HOUSE, BALLARD ESTATE, MUMBAI 400001, STATE OF MAHARASHTRA, INDIA.			
<b>DATE OF REGISTRATION</b>	17/12/2012		
<b>TITLE</b>	MOULDED CASE CIRCUIT BREAKER		
<b>PRIORITY NA</b>			
<b>DESIGN NUMBER</b>	250329		
<b>CLASS</b>	12-11		
<b>1) TUBE INVESTMENTS OF INDIA LIMITED, AN INDIAN COMPANY INCORPORATED UNDER THE COMPANIES ACT OF 1956, HAVING ITS PRINCIPAL PLACE OF BUSINESS AT</b> "DARE HOUSE", 234, N. S. C. BOSE ROAD, CHENNAI - 600001, STATE OF TAMIL NADU, INDIA			
<b>DATE OF REGISTRATION</b>	19/12/2012		
<b>TITLE</b>	HANDLE BAR GRIP FOR TWO WHEELER		
<b>PRIORITY NA</b>			
<b>DESIGN NUMBER</b>	246523		
<b>CLASS</b>	09-01		
<b>1) PEPSICO, INC., INCORPORATED IN NORTH CAROLINA</b> OF 700 ANDERSON HILL ROAD, PURCHASE, NEW YORK 10577, UNITED STATES OF AMERICA			
<b>DATE OF REGISTRATION</b>	16/07/2012		
<b>TITLE</b>	BEVERAGE DISPENSER		
<b>PRIORITY</b>			
<b>PRIORITY NUMBER</b>	<b>DATE</b>	<b>COUNTRY</b>	
29/411, 038	16/01/2012	U.S.A.	

<b>DESIGN NUMBER</b>	251367	
<b>CLASS</b>	06-04	
<b>1)(1) LAVJIBHAI POPATBHAI SHINGALA (2) BHAVESHBHAI LAVJIBHAI SHINGALA AN INDIAN NATIONAL AND PARTNERS OF SHIVAM STEEL FURNITURE (A PARTNERSHIP FIRM) HAVING HIS PLACE OF BUSINESS AT KOTHARIYA RING ROAD, B/H. MURLIDHAR WAY-BRIDGE, MARUTI INDUSTRIAL AREA, STREET NO. 2, RAJKOT-360003 GUJARAT (INDIA)</b>		
<b>DATE OF REGISTRATION</b>	01/02/2013	
<b>TITLE</b>	CUPBOARD	
<b>PRIORITY NA</b>		
<b>DESIGN NUMBER</b>	253175	
<b>CLASS</b>	08-02	
<b>1)VIKAS KALRA TRADING AS: FLAIR PRODUCTS, Y-10-A, LOHA MANDI, NARAINA, NEW DELHI 110028, DELHI STATE, INDIA, INDIAN NATIONAL, SOLE-PROPRIETORSHIP FIRM</b>		
<b>DATE OF REGISTRATION</b>	16/04/2013	
<b>TITLE</b>	HAMMER	
<b>PRIORITY NA</b>		
<b>DESIGN NUMBER</b>	253267	
<b>CLASS</b>	12-16	
<b>1)BAJAJ AUTO LIMITED, AN INDIAN COMPANY, INCORPORATED UNDER THE COMPANIES ACT OF 1956, HAVING ITS PRINCIPAL PLACE OF BUSINESS AT NEW 2ND &amp; 3RD FLOOR, KHIVRAJ BUILDING, NO. 616, ANNASALAI, CHENNAI - 600006, STATE OF TAMIL NADU, INDIA, AND REGISTERED OFFICE AT AKURDI, PUNE-411035, STATE OF MAHARASHTRA, INDIA</b>		
<b>DATE OF REGISTRATION</b>	22/04/2013	
<b>TITLE</b>	WHEEL RIM FOR VEHICLE	
<b>PRIORITY NA</b>		

<b>DESIGN NUMBER</b>	234194	
<b>CLASS</b>	09-01	
<b>1)RAJENDRA CHIMANLAL BRAHAMBHATT TRADING AS SR ENTERPRISES.</b> 1ST FLOOR, PATHIK APARTMENT, PARLE POINT, SURAT-395 007., GUJARAT, INDIA.		
<b>DATE OF REGISTRATION</b>	01/02/2011	
<b>TITLE</b>	BOTTLE	
<b>PRIORITY NA</b>		
		
<b>DESIGN NUMBER</b>	251500	
<b>CLASS</b>	09-07	
<b>1)ACCESS BUSINESS GROUP INTERNATIONAL LLC,</b> 7575 FULTON STREET EAST, ADA, MICHIGAN 49355, U.S.A., A MICHIGAN LIMITED LIABILITY COMPANY, U.S.A.		
<b>DATE OF REGISTRATION</b>	07/02/2013	
<b>TITLE</b>	CONTAINER CLOSURE	
<b>PRIORITY</b>		
<b>PRIORITY NUMBER</b>	<b>DATE</b>	<b>COUNTRY</b>
29/430,194	22/08/2012	U.S.A.
		
<b>DESIGN NUMBER</b>	251518	
<b>CLASS</b>	12-11	
<b>1)BAJAJ AUTO LIMITED, AN INDIAN COMPANY, INCORPORATED UNDER THE COMPANIES ACT OF 1956, HAVING ITS PRINCIPAL PLACE OF BUSINESS AT NEW 2ND &amp; 3RD FLOOR, KHIVRAJ BUILDING, NO. 616, ANNASALAI, CHENNAI - 600006, STATE OF TAMIL NADU, INDIA,</b> AND REGISTERED OFFICE AT AKURDI, PUNE-411035, STATE OF MAHARASHTRA, INDIA		
<b>DATE OF REGISTRATION</b>	08/02/2013	
<b>TITLE</b>	SWING ARM FOR MOTORCYCLE	
<b>PRIORITY NA</b>		
		

<b>DESIGN NUMBER</b>	251534	
<b>CLASS</b>	12-11	
<b>1)BAJAJ AUTO LIMITED, AN INDIAN COMPANY, INCORPORATED UNDER THE COMPANIES ACT OF 1956, HAVING ITS PRINCIPAL PLACE OF BUSINESS AT NEW 2ND &amp; 3RD FLOOR, KHIVRAJ BUILDING, NO. 616, ANNASALAI, CHENNAI - 600006, STATE OF TAMIL NADU, INDIA, AND REGISTERED OFFICE AT AKURDI, PUNE-411035, STATE OF MAHARASHTRA, INDIA</b>		
<b>DATE OF REGISTRATION</b>	08/02/2013	
<b>TITLE</b>	HANDLE HOLDER FOR MOTORCYCLE	
<b>PRIORITY NA</b>		
<b>DESIGN NUMBER</b>	251562	
<b>CLASS</b>	09-01	
<b>1)PRAKASH MAGILALJI BORANA AN INDIAN PROPRIETOR FIRM OF SKY INDUSTRIES, 112-A TIRUPATI UDYOG NAGAR, SATIVALI ROAD, VASAI (E), DIST. THANE, MAHARASHTRA, INDIA OF ABOVE ADDRESS</b>		
<b>DATE OF REGISTRATION</b>	11/02/2013	
<b>TITLE</b>	BOTTLE	
<b>PRIORITY NA</b>		
<b>DESIGN NUMBER</b>	251627	
<b>CLASS</b>	25-02	
<b>1)SYNERGY THRISLINGTON, A 1, PHASE-1, INDUSTRIAL AREA, MOHALI-160055 (PUNJAB) INDIA AN INDIAN PROPRIETORSHIP FIRM WHOSE PROPRIETOR IS :- HARPAL SINGH BEING INDIAN NATIONALS OF THE ABOVE ADDRESS</b>		
<b>DATE OF REGISTRATION</b>	14/02/2013	
<b>TITLE</b>	PARTITION WALL FOR BUILDING CONSTRUCTION	
<b>PRIORITY NA</b>		

<b>DESIGN NUMBER</b>	251676	
<b>CLASS</b>	23-02	
<b>1)GEBERIT INTERNATIONAL AG, SCHACHENSTRASSE 77, 8645 JONA, SWITZERLAND, A COMPANY OF SWITZERLAND</b>		
<b>DATE OF REGISTRATION</b>	14/02/2013	
<b>TITLE</b>	WATER CLOSET	
<b>PRIORITY</b>		
<b>PRIORITY NUMBER</b>	<b>DATE</b>	<b>COUNTRY</b>
686488701	16/08/2012	WIPO

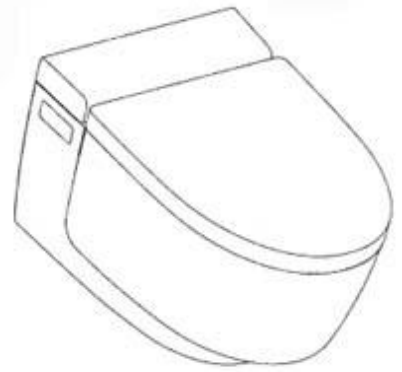

<b>DESIGN NUMBER</b>	250833	
<b>CLASS</b>	08-08	
<b>1)(1). BANKIMBHAI VELJIBHAI MANVAR, (2) ALPESHBHAI HASMUKHBHAI PARIKH (3) VINESHBHAI RATILAL DADHANIYA (4). MITKUMAR KISHORBHAI DEPANI., ALL INDIAN NATIONAL PARTNERS OF M/S. BARRY CREATION., AN INDIAN PARTNERSHIP FIRM., HAVING ITS PRINCIPLE PLACE OF BUSINESS AT, 901, RAVI TOWER, OPP. PARIMAL SCHOOL, KALAWAD ROAD, RAJKOT-360004. GUJARAT-INDIA</b>		
<b>DATE OF REGISTRATION</b>	07/01/2013	
<b>TITLE</b>	CURTAIN FITTING	
<b>PRIORITY NA</b>		







<b>DESIGN NUMBER</b>	252973	
<b>CLASS</b>	28-03	
<b>1)B. R. PLASTICS, AN INDIAN PARTNERSHIP FIRM, WHOSE OFFICE AT 59, 3RD BHOIWADA, BHULESHWAR, MUMBAI-400002, MAHARASHTRA, INDIA AND FACTORY AT 314, A TO Z INDUSTRIAL ESTATE, 3RD FLOOR, G. KADAM MARG, MUMBAI-400013, MAHARASHTRA, INDIA, WHOSE PARTNERS ARE SURENDRA RAMANLAL SHAH, RAJESH RAMANLAL SHAH, UDAY RAMANLAL SHAH AND PARAG SURENDRA SHAH, ALL INDIANS AND ALL BEING PARTNERS AND OF ABOVE ADDRESS</b>		
<b>DATE OF REGISTRATION</b>	09/04/2013	
<b>TITLE</b>	COMB	
<b>PRIORITY NA</b>		







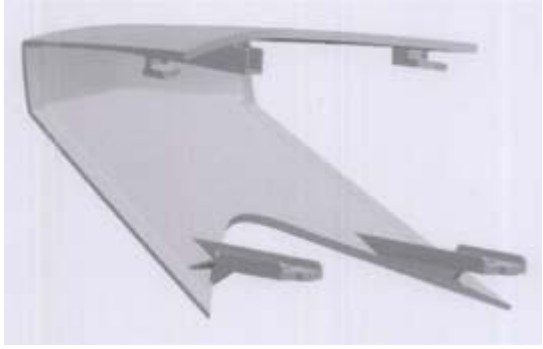

<b>DESIGN NUMBER</b>	252985		
<b>CLASS</b>	09-01		
<b>1)TROIKAA PHARMACEUTICALS LIMITED, AN INDIAN COMPANY INCORPORATED UNDER THE COMPANIES ACT, 1956</b> OF 'COMMERCE HOUSE-1', SATYA MARG, BODAKDEV, AHMEDABAD 380054, STATE OF GUJARAT, INDIA			
<b>DATE OF REGISTRATION</b>	09/04/2013		
<b>TITLE</b>	SPRAY BOTTLE		
<b>PRIORITY NA</b>			
<b>DESIGN NUMBER</b>	253797		
<b>CLASS</b>	03-04		
<b>1)AMANPREET SINGH KAKKAR AND PARMINDER SINGH KAKKAR (BOTH INDIAN NATIONALS) TRADING AS M/S. KAKKAR ELEMENT STORE (REGD.),</b> 16, RAJASTHANI UDYOG NAGAR, NEAR JAHANGIR PURI METRO PILLAR NO-119, GATE NO-1, DELHI-110033			
<b>DATE OF REGISTRATION</b>	14/05/2013		
<b>TITLE</b>	CEILING FAN		
<b>PRIORITY NA</b>			
<b>DESIGN NUMBER</b>	248197		
<b>CLASS</b>	14-03		
<b>1)RESEARCH IN MOTION LIMITED, A CANADIAN CORPORATION</b> OF 295 PHILLIP STREET, WATERLOO, ONTARIO N2L 3W8, CANADA			
<b>DATE OF REGISTRATION</b>	27/09/2012		
<b>TITLE</b>	MOBILE PHONE		
<b>PRIORITY</b>			
<b>PRIORITY NUMBER</b>	<b>DATE</b>	<b>COUNTRY</b>	
29/417052	29/03/2012	U.S.A.	

<b>DESIGN NUMBER</b>	248243	
<b>CLASS</b>	09-01	
<b>1)AGUAS DE SOLAN DE CABRAS, S.A. COMPANY ORGANIZED AND EXISTING IN SPAIN HAVING REGISTERED OFFICE</b> AT 16870, BETETA, PARAJE DE SOLAN DE CABRAS, CUENCA, SPAIN		
<b>DATE OF REGISTRATION</b>	27/09/2012	
<b>TITLE</b>	BOTTLE	
<b>PRIORITY NA</b>		
<b>DESIGN NUMBER</b>	252808	
<b>CLASS</b>	11-02	
<b>1)MA DESIGN INDIA PRIVATE LIMITED, A COMPANY INCORPORATED IN INDIA HAVING ITS PRINCIPAL PLACE OF BUSINESS</b> AT A-41, SECTOR-80, PHASE-II, NOIDA-201305, U.P. INDIA		
<b>DATE OF REGISTRATION</b>	03/04/2013	
<b>TITLE</b>	BOX (FOR JEWELLERY)	
<b>PRIORITY NA</b>		
<b>DESIGN NUMBER</b>	252861	
<b>CLASS</b>	10-01	
<b>1)AJANTA LIMITED, AN INDIAN COMPANY OF ORPAT INDUSTRIAL ESTATE, RAJKOT-MORBI HIGHWAY, MORBI 363641, STATE OF GUJARAT, INDIA</b>		
<b>DATE OF REGISTRATION</b>	03/04/2013	
<b>TITLE</b>	CLOCK	
<b>PRIORITY NA</b>		

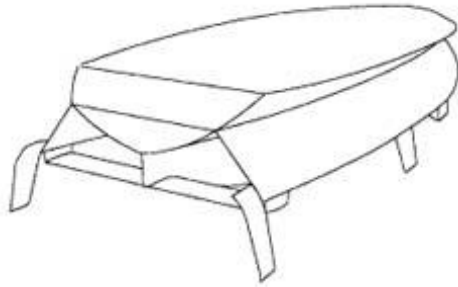
<b>DESIGN NUMBER</b>	250266	
<b>CLASS</b>	13-03	
<b>1) LARSEN &amp; TOUBRO LIMITED, AN INDIAN COMPANY INCORPORATED UNDER THE COMPANIES ACT, 1956 OF L &amp; T HOUSE, BALLARD ESTATE, MUMBAI 400001, STATE OF MAHARASHTRA, INDIA.</b>		
<b>DATE OF REGISTRATION</b>	17/12/2012	
<b>TITLE</b>	MOULDED CASE CIRCUIT BREAKER	
<b>PRIORITY NA</b>		
<b>DESIGN NUMBER</b>	253268	
<b>CLASS</b>	12-16	
<b>1) BAJAJ AUTO LIMITED, AN INDIAN COMPANY, INCORPORATED UNDER THE COMPANIES ACT OF 1956, HAVING ITS PRINCIPAL PLACE OF BUSINESS AT NEW 2ND &amp; 3RD FLOOR, KHIVRAJ BUILDING, NO. 616, ANNASALAI, CHENNAI - 600006, STATE OF TAMIL NADU, INDIA, AND REGISTERED OFFICE AT AKURDI, PUNE-411035, STATE OF MAHARASHTRA, INDIA</b>		
<b>DATE OF REGISTRATION</b>	22/04/2013	
<b>TITLE</b>	WHEEL RIM FOR VEHICLE	
<b>PRIORITY NA</b>		
<b>DESIGN NUMBER</b>	251511	
<b>CLASS</b>	12-11	
<b>1) BAJAJ AUTO LIMITED, AN INDIAN COMPANY, INCORPORATED UNDER THE COMPANIES ACT OF 1956, HAVING ITS PRINCIPAL PLACE OF BUSINESS AT NEW 2ND &amp; 3RD FLOOR, KHIVRAJ BUILDING, NO. 616, ANNASALAI, CHENNAI - 600006, STATE OF TAMIL NADU, INDIA, AND REGISTERED OFFICE AT AKURDI, PUNE-411035, STATE OF MAHARASHTRA, INDIA</b>		
<b>DATE OF REGISTRATION</b>	08/02/2013	
<b>TITLE</b>	CENTRAL TOP SEAT COWL FOR MOTORCYCLE	
<b>PRIORITY NA</b>		

<b>DESIGN NUMBER</b>	251519		
<b>CLASS</b>	12-11		
<b>1)BAJAJ AUTO LIMITED, AN INDIAN COMPANY, INCORPORATED UNDER THE COMPANIES ACT OF 1956, HAVING ITS PRINCIPAL PLACE OF BUSINESS AT NEW 2ND &amp; 3RD FLOOR, KHIVRAJ BUILDING, NO. 616, ANNASALAI, CHENNAI - 600006, STATE OF TAMIL NADU, INDIA, AND REGISTERED OFFICE AT AKURDI, PUNE-411035, STATE OF MAHARASHTRA, INDIA</b>			
<b>DATE OF REGISTRATION</b>	08/02/2013		
<b>TITLE</b>	HOLDER STEP FOR MOTORCYCLE		
<b>PRIORITY NA</b>			
<b>DESIGN NUMBER</b>	251535		
<b>CLASS</b>	12-11		
<b>1)BAJAJ AUTO LIMITED, AN INDIAN COMPANY, INCORPORATED UNDER THE COMPANIES ACT OF 1956, HAVING ITS PRINCIPAL PLACE OF BUSINESS AT NEW 2ND &amp; 3RD FLOOR, KHIVRAJ BUILDING, NO. 616, ANNASALAI, CHENNAI - 600006, STATE OF TAMIL NADU, INDIA, AND REGISTERED OFFICE AT AKURDI, PUNE-411035, STATE OF MAHARASHTRA, INDIA</b>			
<b>DATE OF REGISTRATION</b>	08/02/2013		
<b>TITLE</b>	FRONT FAIRING ASSEMBLY FOR MOTORCYCLE		
<b>PRIORITY NA</b>			
<b>DESIGN NUMBER</b>	251544		
<b>CLASS</b>	12-06		
<b>1)ANWIGEMA B.V., OF THE ADDRESS LAAN VAN EUROPA 237 4701 DB ROOSENDAAL THE NETHERLANDS</b>			
<b>DATE OF REGISTRATION</b>	11/02/2013		
<b>TITLE</b>	HULL FOR VEHICLE FOR LOCOMOTION BY WATER		
<b>PRIORITY</b>			
<b>PRIORITY NUMBER</b>	<b>DATE</b>	<b>COUNTRY</b>	
002088096-0001	15/08/2012	EUROPEAN UNION	

<b>DESIGN NUMBER</b>	251628	
<b>CLASS</b>	25-02	
<b>1)SYNERGY THRISLINGTON, A 1, PHASE-1, INDUSTRIAL AREA, MOHALI-160055 (PUNJAB) INDIA</b> AN INDIAN PROPRIETORSHIP FIRM WHOSE PROPRIETOR IS :- HARPAL SINGH BEING INDIAN NATIONALS OF THE ABOVE ADDRESS		
<b>DATE OF REGISTRATION</b>	14/02/2013	
<b>TITLE</b>	PARTITION WALL FOR BUILDING CONSTRUCTION	
<b>PRIORITY NA</b>		

<b>DESIGN NUMBER</b>	251678	
<b>CLASS</b>	03-01	
<b>1)APPLE INC.,</b> 1 INFINITE LOOP, CUPERTINO, CALIFORNIA 95014, UNITED STATES OF AMERICA, A CORPORATION INCORPORATED IN THE STATE OF CALIFORNIA		
<b>DATE OF REGISTRATION</b>	14/02/2013	
<b>TITLE</b>	COVER FOR PORTABLE DISPLAY DEVICE	
<b>PRIORITY</b>		
<b>PRIORITY NUMBER</b>	<b>DATE</b>	<b>COUNTRY</b>
29/431,559	07/09/2012	U.S.A.

<b>DESIGN NUMBER</b>	252915	
<b>CLASS</b>	07-04	
<b>1)ROHITBHAI P. RAIYANI AND PARESHBHAI R. BHAGIYA BOTH INDIAN NATIONAL PARTNER OF ASTRAL KITCHEN APPLIANCES AN INDIAN PARTNERSHIP FIRM HAVING ITS PRINCIPAL PLACE OF BUSINESS AT</b> PLOT NO. 1049, NEAR AJAY WAY-BRIDGE, AJI VASAHAAT, 80 FEET MAIN ROAD, RAJKOT, GUJARAT-INDIA		
<b>DATE OF REGISTRATION</b>	05/04/2013	
<b>TITLE</b>	FLOUR PRESSING APPLIANCE	
<b>PRIORITY NA</b>		

<b>DESIGN NUMBER</b>	252974	
<b>CLASS</b>	28-03	
<b>1)B. R. PLASTICS, AN INDIAN PARTNERSHIP FIRM, WHOSE OFFICE AT 59, 3RD BHOIWADA, BHULESHWAR, MUMBAI-400002, MAHARASHTRA, INDIA AND FACTORY AT 314, A TO Z INDUSTRIAL ESTATE, 3RD FLOOR, G. KADAM MARG, MUMBAI-400013, MAHARASHTRA, INDIA, WHOSE PARTNERS ARE SURENDRA RAMANLAL SHAH, RAJESH RAMANLAL SHAH, UDAY RAMANLAL SHAH AND PARAG SURENDRA SHAH, ALL INDIANS AND ALL BEING PARTNERS AND OF ABOVE ADDRESS</b>		
<b>DATE OF REGISTRATION</b>	09/04/2013	
<b>TITLE</b>	COMB	
<b>PRIORITY NA</b>		

<b>DESIGN NUMBER</b>	253023	
<b>CLASS</b>	05-05	
<b>1)M/S. BIBA APPARELS PRIVATE LIMITED, AN INDIAN PRIVATE LIMITED COMPANY INCORPORATED UNDER THE PROVISION OF THE COMPANIES ACT, 1956, AND HAVING ITS'S REGISTERED OFFICE AT RELIABLE HOUSE, SITUATED AT HANUMAN SILK MILL COMPOUND, KANJURMARG (WEST), OPP. HUMA MALL, MUMBAI-400078 MAHARASHTRA, INDIA</b>		
<b>DATE OF REGISTRATION</b>	11/04/2013	
<b>TITLE</b>	TEXTILE FABRIC	
<b>PRIORITY NA</b>		

<b>DESIGN NUMBER</b>	253115	
<b>CLASS</b>	08-06	
<b>1)VIMALBHAI CHANDUBHAI SHINGALA (INDIAN NATIONALS) PROPRIETOR OF ROCK INDUSTRIES (INDIAN PROPRIETORSHIP CONCERN) HAVING PLACE OF BUSINESS AT- B/H. BALAJI PETROL PUMP, 80 FEET ROAD, SORATHIYAWADI, RAJKOT - 360002, GUJARAT (INDIA)</b>		
<b>DATE OF REGISTRATION</b>	12/04/2013	
<b>TITLE</b>	HANDLE	
<b>PRIORITY NA</b>		

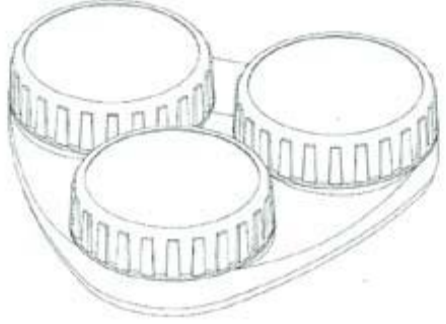
<b>DESIGN NUMBER</b>	253646	
<b>CLASS</b>	09-01	
<b>1)MAHESH PARSANA, INDIAN NATIONAL, OF</b> 402 SUKEN APARTMENT, LIMBUDIWADI MAIN ROAD, RAJKOT 360005, GUJARAT, INDIA		
<b>DATE OF REGISTRATION</b>	03/05/2013	
<b>TITLE</b>	MEDICINE DISPENSER	
<b>PRIORITY NA</b>		

<b>DESIGN NUMBER</b>	253711	
<b>CLASS</b>	09-07	
<b>1)MANIKA MOULDS PVT. LTD., A COMPANY INCORPORATED</b> <b>UNDER THE INDIAN COMPANIES ACT,</b> AAR-PEE CENTRE, 601-605, 6TH FLOOR GUFFIC COMPOUND, MIDC, ANDHERI (E), MUMBAI-400093, MAHARASHTRA, INDIA		
<b>DATE OF REGISTRATION</b>	07/05/2013	
<b>TITLE</b>	BATTERY LID	
<b>PRIORITY NA</b>		

<b>DESIGN NUMBER</b>	248261	
<b>CLASS</b>	08-06	
<b>1)MAHESHBHAI SHIVALALBHAI GAJERA AN INDIAN NATIONAL</b> <b>PROPRIETOR OF SHREE HARIKRUPA DIE CASTING AN INDIAN</b> <b>PROPRIETORSHIP FIRM HAVING ITS PRINCIPAL PLACE OF BUSINESS</b> AT K-1, 242/17, B/4 MEL-TECH, NEAR TURBO BEARING, AJI VASAHAAT GIDC, RAJKOT-360002, GUJARAT-INDIA		
<b>DATE OF REGISTRATION</b>	28/09/2012	
<b>TITLE</b>	HANDLE	
<b>PRIORITY NA</b>		

<b>DESIGN NUMBER</b>	252814	
<b>CLASS</b>	11-02	
<b>1)MA DESIGN INDIA PRIVATE LIMITED, A COMPANY INCORPORATED IN INDIA HAVING ITS PRINCIPAL PLACE OF BUSINESS</b> AT A-41, SECTOR-80, PHASE-II, NOIDA-201305, U.P. INDIA		
<b>DATE OF REGISTRATION</b>	03/04/2013	
<b>TITLE</b>	BOX (FOR JEWELLERY)	
<b>PRIORITY NA</b>		

<b>DESIGN NUMBER</b>	252862	 Front view
<b>CLASS</b>	10-01	
<b>1)AJANTA LIMITED, AN INDIAN COMPANY OF</b> ORPAT INDUSTRIAL ESTATE, RAJKOT-MORBI HIGHWAY, MORBI 363641, STATE OF GUJARAT, INDIA		
<b>DATE OF REGISTRATION</b>	03/04/2013	
<b>TITLE</b>	CLOCK	
<b>PRIORITY NA</b>		

<b>DESIGN NUMBER</b>	252876	 Front view
<b>CLASS</b>	10-01	
<b>1)AJANTA LIMITED, AN INDIAN COMPANY OF</b> ORPAT INDUSTRIAL ESTATE, RAJKOT-MORBI HIGHWAY, MORBI 363641, STATE OF GUJARAT, INDIA		
<b>DATE OF REGISTRATION</b>	03/04/2013	
<b>TITLE</b>	CLOCK	
<b>PRIORITY NA</b>		



<b>DESIGN NUMBER</b>	251148	
<b>CLASS</b>	25-01	
<b>1)GUJARAT BOROSIL LIMITED AN INDIAN COMPANY INCORPORATED UNDER THE PROVISIONS OF THE COMPANIES ACT, HAVING OFFICE AT VILLAGE-GOVALI, TALUKA-JHAGADIA DIST-BHARUCH-393001, INDIA</b>		
<b>DATE OF REGISTRATION</b>	23/01/2013	
<b>TITLE</b>	FIGURED GLASS SHEET	
<b>PRIORITY NA</b>		

<b>DESIGN NUMBER</b>	252251	
<b>CLASS</b>	23-02	
<b>1)OKBABY S.R.L., VIA DEL LAVORO, 26, 24060 TELGATE (BERGAMO), ITALY, AN ITALIAN LIMITED LIABILITY COMPANY</b>		
<b>DATE OF REGISTRATION</b>	11/03/2013	
<b>TITLE</b>	POTTY CHAIR	
<b>PRIORITY</b>		
<b>PRIORITY NUMBER</b>	<b>DATE</b>	<b>COUNTRY</b>
002106617-0001	20/09/2012	OHIM

<b>DESIGN NUMBER</b>	252430	
<b>CLASS</b>	19-06	
<b>1)FLAIR PENS LIMITED, AN INDIAN PARTNERSHIP FIRM OF 63, B/C, GOVT. INDUSTRIAL ESTATE, CHARKOP, KANDIVALI (W), MUMBAI - 400067, [MAHARASHTRA] INDIA</b>		
<b>DATE OF REGISTRATION</b>	19/03/2013	
<b>TITLE</b>	PEN	
<b>PRIORITY NA</b>		

<b>DESIGN NUMBER</b>	253489	
<b>CLASS</b>	02-04	
<b>1)KHADIM INDIA LIMITED, AN INDIAN COMPANY HAVING ITS REGISTERED OFFICE AT KANKARIA ESTATE, 5TH FLOOR, 6, LITTLE RUSSELL STREET KOLKATA 700071, WEST BENGAL, INDIA.</b>		
<b>DATE OF REGISTRATION</b>	29/04/2013	
<b>TITLE</b>	FOOTWEAR	
<b>PRIORITY NA</b>		
<b>DESIGN NUMBER</b>	252572	
<b>CLASS</b>	23-02	
<b>1)KARSANBHAI MOHANBHAI PATEL, JALPABEN VISHALBHAI PANDIT, INDUBEN KARSANBHAI PATEL AND NIKITABEN DEEPAKBHAI VACHHANI ALL INDIAN NATIONAL PARTNERS OF EROS FOR SANITARYWARES AN INDIAN PARTNERSHIP FIRM HAVING ITS PRINCIPAL PLACE OF BUSINESS AT SHOBHESHWAR ROAD, OPP. PICNIC CENTRE, P.O. BOX NO-342, MORBI-2, GUJARAT-INDIA</b>		
<b>DATE OF REGISTRATION</b>	21/03/2013	
<b>TITLE</b>	WASHBASIN WITH PEDESTAL	
<b>PRIORITY NA</b>		
<b>DESIGN NUMBER</b>	252655	
<b>CLASS</b>	06-01	
<b>1)(1) VIKAS JAIN S/O. SH. BHIKAM CHAND (NATIONALITY-INDIAN), (2) SMT. KIRAN CHARAN W/O. SH. SUMER SINGH CHARAN (NATIONALITY-INDIAN) PARTNERS OF J. C. ANTIQUES &amp; CRAFTS AT- G-165 TO G-167, SITAPURA INDUSTRIAL AREA, JAIPUR-302022 (RAJASTHAN) NATIONALITY-INDIAN.</b>		
<b>DATE OF REGISTRATION</b>	26/03/2013	
<b>TITLE</b>	BED	
<b>PRIORITY NA</b>		

<b>DESIGN NUMBER</b>	251388	
<b>CLASS</b>	12-08	
<b>1)BAYERISCHE MOTOREN WERKE AKTIENGESELLSCHAFT, OF</b> PETUELRING 130, 80809, MUNICH, GERMANY, A GERMAN COMPANY		
<b>DATE OF REGISTRATION</b>	04/02/2013	
<b>TITLE</b>	CAR	
<b>PRIORITY</b>		
<b>PRIORITY NUMBER</b>	<b>DATE</b>	<b>COUNTRY</b>
DE 402012100670.3	22/08/2012	GERMANY



<b>DESIGN NUMBER</b>	253191	
<b>CLASS</b>	23-01	
<b>1)RAJHANS CHEMICALS &amp; PLASTIC INDUSTRIES, B-70/76, DSIDC INDUSTRIAL AREA, LAWRENCE ROAD, DELHI-110035, INDIA.</b> (AN INDIAN PARTNERSHIP FIRM WHOSE PARTNERS ARE :- SH. SANJEEV JAIN AND SMT. SHAKUNTLA DEVI JAIN AN INDIAN NATIONAL OF THE ABOVE ADDRESS		
<b>DATE OF REGISTRATION</b>	16/04/2013	
<b>TITLE</b>	WATER TAP	
<b>PRIORITY NA</b>		



<b>DESIGN NUMBER</b>	253242	
<b>CLASS</b>	06-08	
<b>1)JOYFUL PLASTICS PRIVATE LIMITED, A COMPANY REGISTERED IN INDIA, HAVING ITS REGISTERED OFFICE AT</b> 20, A/F, NEW EMPIRE INDUSTRIAL ESTATE, KONDIVITA ROAD, J.B. NAGAR, ANDHERI (E), MUMBAI-400059, STATE OF MAHARASHTRA, INDIA, OF ABOVE ADDRESS		
<b>DATE OF REGISTRATION</b>	18/04/2013	
<b>TITLE</b>	HANGER	
<b>PRIORITY NA</b>		



<b>DESIGN NUMBER</b>	253279	
<b>CLASS</b>	23-04	
<b>1)MITSUBISHI ELECTRIC CORPORATION, A JAPANESE COMPANY ORGANIZED AND EXISTING UNDER THE LAWS OF JAPAN, MANUFACTURERS AND MERCHANTS, OF THE ADDRESS</b> 7-3, MARUNOUCHI 2-CHOME, CHIYODA-KU, TOKYO 100-8310, JAPAN		
<b>DATE OF REGISTRATION</b>	22/04/2013	
<b>TITLE</b>	EXHAUST FAN	
<b>PRIORITY</b>		
<b>PRIORITY NUMBER</b>	<b>DATE</b>	<b>COUNTRY</b>
2013-001199	24/01/2013	JAPAN

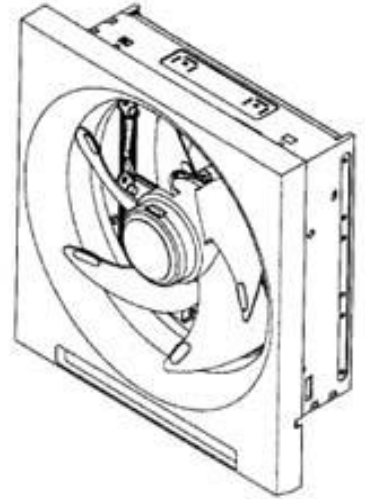

<b>DESIGN NUMBER</b>	251515	
<b>CLASS</b>	12-11	
<b>1)BAJAJ AUTO LIMITED, AN INDIAN COMPANY, INCORPORATED UNDER THE COMPANIES ACT OF 1956, HAVING ITS PRINCIPAL PLACE OF BUSINESS AT NEW 2ND &amp; 3RD FLOOR, KHIVRAJ BUILDING, NO. 616, ANNASALAI, CHENNAI - 600006, STATE OF TAMIL NADU, INDIA,</b> AND REGISTERED OFFICE AT AKURDI, PUNE-411035, STATE OF MAHARASHTRA, INDIA		
<b>DATE OF REGISTRATION</b>	08/02/2013	
<b>TITLE</b>	FRONT FENDER ASSEMBLY FOR MOTORCYCLE	
<b>PRIORITY NA</b>		

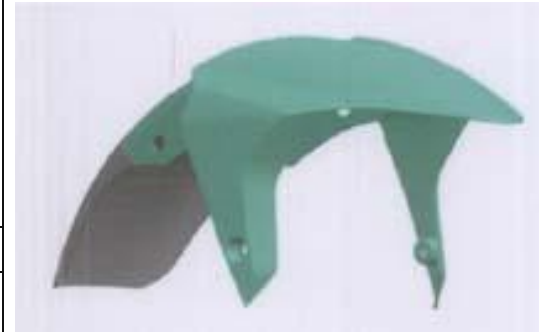

<b>DESIGN NUMBER</b>	251618	
<b>CLASS</b>	12-16	
<b>1)ESCORTS LIMITED, OF</b> 15/5, KM, MATHURA ROAD, FARIDABAD-121003, HARYANA, INDIA, AN INDIAN COMPANY		
<b>DATE OF REGISTRATION</b>	13/02/2013	
<b>TITLE</b>	BRAKE CYLINDER	
<b>PRIORITY NA</b>		



<b>DESIGN NUMBER</b>	248507	
<b>CLASS</b>	09-07	
<b>1) L'AIR LIQUIDE, SOCIETE ANONYME POUR L'ETUDE ET L'EXPLOITATION DES PROCEDES GEORGES CLAUDE, A FRENCH COMPANY HAVING ITS ADDRESS AT 75, QUAI D'ORSAY, 75007 PARIS, FRANCE</b>		
<b>DATE OF REGISTRATION</b>	08/10/2012	
<b>TITLE</b>	GAS CYLINDER CAP	
<b>PRIORITY</b>		
<b>PRIORITY NUMBER</b>	<b>DATE</b>	<b>COUNTRY</b>
664886101	19/04/2012	WIPO



<b>DESIGN NUMBER</b>	252937	
<b>CLASS</b>	12-15	
<b>1) COMPAGNIE GENERALE DES ETABLISSEMENTS MICHELIN, A FRENCH COMPANY OF 12 COURS SABLON, FR-63000, CLERMONT-FERRAND, FRANCE, AND MICHELIN RECHERCHE ET TECHNIQUE S.A., A SWISS COMPANY OF ROUTE LOUIS BRAILLE 10-CH-1763, GRANGES-PACCOT, SWITZERLAND</b>		
<b>DATE OF REGISTRATION</b>	08/04/2013	
<b>TITLE</b>	TIRE	
<b>PRIORITY</b>		
<b>PRIORITY NUMBER</b>	<b>DATE</b>	<b>COUNTRY</b>
29/435,478	24/10/2012	U.S.A.

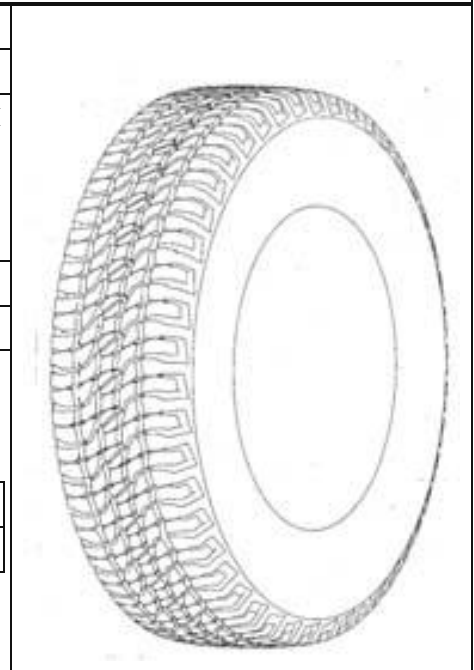

<b>DESIGN NUMBER</b>	252981	
<b>CLASS</b>	28-03	
<b>1) B. R. PLASTICS, AN INDIAN PARTNERSHIP FIRM, WHOSE OFFICE AT 59, 3RD BHOIWADA, BHULESHWAR, MUMBAI-400002, MAHARASHTRA, INDIA AND FACTORY AT 314, A TO Z INDUSTRIAL ESTATE, 3RD FLOOR, G. KADAM MARG, MUMBAI-400013, MAHARASHTRA, INDIA, WHOSE PARTNERS ARE SURENDRA RAMANLAL SHAH, RAJESH RAMANLAL SHAH, UDAY RAMANLAL SHAH AND PARAG SURENDRA SHAH, ALL INDIANS AND ALL BEING PARTNERS AND OF ABOVE ADDRESS</b>		
<b>DATE OF REGISTRATION</b>	09/04/2013	
<b>TITLE</b>	COMB	
<b>PRIORITY NA</b>		



<b>DESIGN NUMBER</b>	253119		
<b>CLASS</b>	08-06		
<b>1)CHHANDRAKANTBHAI RANCHODDBHAI RANGANI (INDIAN NATIONALS) SOLE PROPRIETOR OF DEV MARKETING (INDIAN PROPRIETORSHIP CONCERN) HAVING PLACE OF BUSINESS AT- NR. BHILAI WAY, BRIDGE FURNITURE STREET, JILLA GARDEN MAIN ROAD, BAPUNAGAR, RAJKOT-GUJARAT (INDIA)</b>			
<b>DATE OF REGISTRATION</b>	12/04/2013		
<b>TITLE</b>	HANDLE		
<b>PRIORITY NA</b>			
<b>DESIGN NUMBER</b>	253810		
<b>CLASS</b>	28-03		
<b>1)(1)MANOJKUMAR CHANDULAL RANPARA (2)TUSHARBHAI MANOJKUMAR RANPARA (3)DEVANGBHAI MANOJKUMAR RANPARA (ALL THE PARTNERS ARE ADULT &amp; INDIAN NATIONALS) PARTNER OF NEW RANPARA INDUSTRIES (INDIAN PARTNERSHIP FIRM) HAVING PLACE OF BUSINESS AT -PANCHASAR ROAD, B/H. GEETA OIL MILL, MORBI-363641 DISTRICT:RAJKOT-GUJARAT (INDIA)</b>			
<b>DATE OF REGISTRATION</b>	15/05/2013		
<b>TITLE</b>	TONGUE CLEANER		
<b>PRIORITY NA</b>			
<b>DESIGN NUMBER</b>	246239		
<b>CLASS</b>	28-03		
<b>1)JIRO TAKASHIMA, P.O. BOX 55427, HOUSTON, TEXAS 77255 USA</b>			
<b>DATE OF REGISTRATION</b>	26/06/2012		
<b>TITLE</b>	MESSAGE DEVICE		
<b>PRIORITY</b>			
<b>PRIORITY NUMBER</b>	<b>DATE</b>	<b>COUNTRY</b>	
29/409737	28/12/2011	U.S.A.	
<b>PRIORITY NA</b>			

<b>DESIGN NUMBER</b>	252804	
<b>CLASS</b>	07-01	
<b>1)MA DESIGN INDIA PRIVATE LIMITED, A COMPANY INCORPORATED IN INDIA HAVING ITS PRINCIPAL PLACE OF BUSINESS</b> AT A-41, SECTOR-80, PHASE-II, NOIDA-201305, U.P. INDIA		
<b>DATE OF REGISTRATION</b>	03/04/2013	
<b>TITLE</b>	LID	
<b>PRIORITY NA</b>		



<b>DESIGN NUMBER</b>	252824	
<b>CLASS</b>	09-07	
<b>1)RECKITT BENCKISER N. V., A DUTCH COMPANY OF SIRIUSDREEF 14, 2132 WT HOOFDORP, NETHERLANDS</b>		
<b>DATE OF REGISTRATION</b>	03/04/2013	
<b>TITLE</b>	CAP	
<b>PRIORITY</b>		
<b>PRIORITY NUMBER</b>	<b>DATE</b>	<b>COUNTRY</b>
002115147	08/10/2012	OHIM

<b>DESIGN NUMBER</b>	252872	
<b>CLASS</b>	10-01	
<b>1)AJANTA LIMITED, AN INDIAN COMPANY OF ORPAT INDUSTRIAL ESTATE, RAJKOT-MORBI HIGHWAY, MORBI 363641, STATE OF GUJARAT, INDIA</b>		
<b>DATE OF REGISTRATION</b>	03/04/2013	
<b>TITLE</b>	CLOCK	
<b>PRIORITY NA</b>		

<b>DESIGN NUMBER</b>	252880	
<b>CLASS</b>	10-01	
<b>1)AJANTA LIMITED, AN INDIAN COMPANY OF</b> ORPAT INDUSTRIAL ESTATE, RAJKOT-MORBI HIGHWAY, MORBI 363641, STATE OF GUJARAT, INDIA		
<b>DATE OF REGISTRATION</b>	03/04/2013	
<b>TITLE</b>	CLOCK	
<b>PRIORITY NA</b>		
<b>DESIGN NUMBER</b>	251025	
<b>CLASS</b>	09-01	
<b>1)MOHD. NASEEM, SOLE PROPRIETOR, TRADING AS AZAD COSMETICS,</b> <b>HAVING ITS OFFICE AT</b> CK-68/25A, KACHCHI SARAY, DALMANDI, VARANASI, U,P INDIA, AN INDIAN, OF THE ABOVE ADDRESS		
<b>DATE OF REGISTRATION</b>	18/01/2013	
<b>TITLE</b>	BOTTLE	
<b>PRIORITY NA</b>		
<b>DESIGN NUMBER</b>	252350	
<b>CLASS</b>	31-00	
<b>1)KONINKLIJKE PHILIPS ELECTRONICS N.V., A COMPANY ORGANIZED</b> <b>AND EXISTING UNDER THE LAWS OF THE KINGDOM OF THE</b> <b>NETHERLANDS, RESIDING AT</b> EINDHOVEN, WHOSE POST-OFFICE ADDRESS IS HIGH TECH CAMPUS 5, 5656 AE EINDHOVEN, THE NETHERLANDS		
<b>DATE OF REGISTRATION</b>	15/03/2013	
<b>TITLE</b>	SOYMILK MAKER	
<b>PRIORITY</b>		
<b>PRIORITY NUMBER</b>	<b>DATE</b>	<b>COUNTRY</b>
002105213-0001	18/09/2012	OHIM







<b>DESIGN NUMBER</b>	252657	
<b>CLASS</b>	06-01	
<b>1)(1) VIKAS JAIN S/O. SH. BHIKAM CHAND (NATIONALITY-INDIAN), (2) SMT. KIRAN CHARAN W/O. SH. SUMER SINGH CHARAN (NATIONALITY-INDIAN) PARTNERS OF J. C. ANTIQUES &amp; CRAFTS</b> AT- G-165 TO G-167, SITAPURA INDUSTRIAL AREA, JAIPUR-302022 (RAJASTHAN) NATIONALITY-INDIAN.		
<b>DATE OF REGISTRATION</b>	26/03/2013	
<b>TITLE</b>	BED	
<b>PRIORITY NA</b>		
<b>DESIGN NUMBER</b>	249793	
<b>CLASS</b>	15-07	
<b>1)GODREJ &amp; BOYCE MFG. CO. LTD., AN INDIAN COMPANY INCORPORATED UNDER THE COMPANIES ACT 1913, OF</b> GODREJ INTERIO, PLANT 4, PIROJSHANAGER, VIKHROLI (WEST), MUMBAI-400079, INDIA		
<b>DATE OF REGISTRATION</b>	30/11/2012	
<b>TITLE</b>	REFRIGERATOR	
<b>PRIORITY NA</b>		
<b>DESIGN NUMBER</b>	253172	
<b>CLASS</b>	09-01	
<b>1)MR. KAMAL MOTWANI, NATIONALITY INDIAN WHOSE ADDRESS IS</b> SHED NO-24, HSIDC COMPLEX, MANGOLPURI INDUSTRIAL AREA, NEW DELHI-110087 (INDIA)		
<b>DATE OF REGISTRATION</b>	16/04/2013	
<b>TITLE</b>	BOTTLE	
<b>PRIORITY NA</b>		

<b>DESIGN NUMBER</b>	253196	
<b>CLASS</b>	23-01	
<b>1)ASHWINBHAI BABUBHAI KAPURIYA, ADULT, INDIAN INHABITANT, HAVING ADDRESS AT</b> AKSHAR BHUVAN, MURLIDHAR NAGAR 3, RADAR ROAD, SERRY NO. 12, JAMNAGAR-361004, GUJARAT STATE, INDIA		
<b>DATE OF REGISTRATION</b>	17/04/2013	
<b>TITLE</b>	PRESSURE REGULATOR	
<b>PRIORITY NA</b>		
<b>DESIGN NUMBER</b>	253243	
<b>CLASS</b>	09-01	
<b>1)1)MR. MAULESH D. UKANI 2)MRS. SONALBEN M. UKANI AND 3)MR. JAY M. UKANI, PARTNERS-INDIAN NATIONAL TRADING AS DWARIKADHISH HOLDINGS, HAVING ITS REGISTERED OFFICE AT</b> BAN HOUSE, DR. VIKRAM SARABHAI NAGAR, GONDAL ROAD, RAJKOT-360004, INDIA, OF ABOVE ADDRESS		
<b>DATE OF REGISTRATION</b>	18/04/2013	
<b>TITLE</b>	BOTTLE	
<b>PRIORITY NA</b>		
<b>DESIGN NUMBER</b>	253283	
<b>CLASS</b>	23-04	
<b>1)MITSUBISHI ELECTRIC CORPORATION, A JAPANESE COMPANY ORGANIZED AND EXISTING UNDER THE LAWS OF JAPAN, MANUFACTURERS AND MERCHANTS, OF THE ADDRESS</b> 7-3, MARUNOUCHI 2-CHOME, CHIYODA-KU, TOKYO 100-8310, JAPAN		
<b>DATE OF REGISTRATION</b>	22/04/2013	
<b>TITLE</b>	FAN GUARD	
<b>PRIORITY</b>		
<b>PRIORITY NUMBER</b>	<b>DATE</b>	<b>COUNTRY</b>
2012-026935	06/11/2012	JAPAN



<b>DESIGN NUMBER</b>	237902	
<b>CLASS</b>	06-13	
<b>1)EICHER GOOD EARTH PVT. LTD., EICHER HOUSE 12-COMMERCIAL COMPLEX, MASJID MOTH, GREATER KAILASH-II, NEW DELHI-110048, INDIA</b>		
<b>DATE OF REGISTRATION</b>	08/07/2011	
<b>TITLE</b>	CUSHION COVER	
<b>PRIORITY NA</b>		

<b>DESIGN NUMBER</b>	251516	
<b>CLASS</b>	12-11	
<b>1)BAJAJ AUTO LIMITED, AN INDIAN COMPANY, INCORPORATED UNDER THE COMPANIES ACT OF 1956, HAVING ITS PRINCIPAL PLACE OF BUSINESS AT NEW 2ND &amp; 3RD FLOOR, KHIVRAJ BUILDING, NO. 616, ANNASALAI, CHENNAI - 600006, STATE OF TAMIL NADU, INDIA, AND REGISTERED OFFICE AT AKURDI, PUNE-411035, STATE OF MAHARASHTRA, INDIA</b>		
<b>DATE OF REGISTRATION</b>	08/02/2013	
<b>TITLE</b>	REAR HUGGER ASSEMBLY FOR MOTORCYCLE	
<b>PRIORITY NA</b>		

<b>DESIGN NUMBER</b>	251554	
<b>CLASS</b>	13-01	
<b>1)AAZAM KHAN (AN INDIAN NATIONAL) TRADING AS M/S. KINZA SEWING MACHINE COMPANY, A-12/275, BRIJPURI, DELHI-110094</b>		
<b>DATE OF REGISTRATION</b>	11/02/2013	
<b>TITLE</b>	ELECTRIC MOTOR	
<b>PRIORITY NA</b>		

<b>DESIGN NUMBER</b>	248523	
<b>CLASS</b>	26-02	
<b>1)1. MR. SHASHANK S. MEHTA (PARTNER-INDIAN RESIDENT), 2. MR. SAMIR S. KOTHARI (PARTNER-INDIAN RESIDENT), 3. MRS. SONAL S. MEHTA (PARTNER-INDIAN RESIDENT), 4. MRS. SUDHA S. MEHTA (PARTNER-INDIAN RESIDENT) AND 5. MRS. ANISHA S. KOTHARI (PARTNER-INDIAN RESIDENT), TRADING AS M/S. INDIA IMPEX (SOLAR DIVISION) (A PARTNERSHIP FIRM REGISTERED UNDER THE PARTNERSHIP ACT, 1932)</b> WHOSE ADDRESS IS 4, BRADY GLADY'S PLAZA, 1/447, SENAPATI BAPAT MARG, LOWER PAREL, MUMBAI-400013.		
<b>DATE OF REGISTRATION</b>	10/10/2012	
<b>TITLE</b>	SOLAR LANTERN	
<b>PRIORITY NA</b>		
<b>DESIGN NUMBER</b>	250831	
<b>CLASS</b>	08-08	
<b>1)(1). BANKIMBHAI VELJIBHAI MANVAR, (2) ALPESHBHAI HASMUKHBHAI PARIKH (3) VINESHBHAI RATILAL DADHANIYA (4). MITKUMAR KISHORBHAI DEPANI., ALL INDIAN NATIONAL PARTNERS OF M/S. BARRY CREATION., AN INDIAN PARTNERSHIP FIRM., HAVING ITS PRINCIPLE PLACE OF BUSINESS AT,</b> 901, RAVI TOWER, OPP. PARIMAL SCHOOL, KALAWAD ROAD, RAJKOT-360004. GUJARAT-INDIA		
<b>DATE OF REGISTRATION</b>	07/01/2013	
<b>TITLE</b>	CURTAIN FITTING	
<b>PRIORITY NA</b>		
<b>DESIGN NUMBER</b>	252938	
<b>CLASS</b>	12-08	
<b>1)DR. ING. H.C.F. PORSCHE AKTIENGESELLSCHAFT, A GERMAN COMPANY OF</b> PORSCHEPLATZ 1, 70435 STUTTGART, GERMANY		
<b>DATE OF REGISTRATION</b>	08/04/2013	
<b>TITLE</b>	CAR	
<b>PRIORITY NA</b>		

<b>DESIGN NUMBER</b>	252966	
<b>CLASS</b>	21-01	
<b>1)HRIDAYESHWAR SINGH BHATI S/O. SH. SAROWER SINGH BHATI (NATIONALITY-INDIAN)</b> AT-FLAT NO. 302, SRI GOPALAM APARTMENTS, D-233, BIHARI MARG, BEHIND COLLECTORATE, BANI PARK, JAIPUR (RAJ.) NATIONALITY-INDIAN		
<b>DATE OF REGISTRATION</b>	09/04/2013	
<b>TITLE</b>	CHESS BOARD	
<b>PRIORITY NA</b>		

<b>DESIGN NUMBER</b>	252982	
<b>CLASS</b>	28-03	
<b>1)B. R. PLASTICS, AN INDIAN PARTNERSHIP FIRM, WHOSE OFFICE AT 59, 3RD BHOIWADA, BHULESHWAR, MUMBAI-400002, MAHARASHTRA, INDIA AND FACTORY AT 314, A TO Z INDUSTRIAL ESTATE, 3RD FLOOR, G. KADAM MARG, MUMBAI-400013, MAHARASHTRA, INDIA, WHOSE PARTNERS ARE</b> SURENDRA RAMANLAL SHAH, RAJESH RAMANLAL SHAH, UDAY RAMANLAL SHAH AND PARAG SURENDRA SHAH, ALL INDIANS AND ALL BEING PARTNERS AND OF ABOVE ADDRESS		
<b>DATE OF REGISTRATION</b>	09/04/2013	
<b>TITLE</b>	COMB	
<b>PRIORITY NA</b>		

<b>DESIGN NUMBER</b>	253005	
<b>CLASS</b>	09-01	
<b>1)SHREYANS R. BOBDA AND JIGAR S. SHAH BOTH INDIAN NATIONAL PARTNERS OF ARIHANT REMEDIES AN INDIAN PARTNERSHIP FIRM HAVING ITS PRINCIPAL PLACE OF BUSINESS AT</b> PLOT NO. 444, ASWAMEGH INDUSTRIAL ESTATE-II, OPP. M.N. DESAI PETROL PUMP, SARKHEJ-BAWLA N.H. NO. 8/A, CHANGODAR, DIST. AHMEDABAD-382213, GUJARAT-INDIA		
<b>DATE OF REGISTRATION</b>	10/04/2013	
<b>TITLE</b>	CONTAINER	
<b>PRIORITY NA</b>		

<b>DESIGN NUMBER</b>	253120	
<b>CLASS</b>	08-06	
<b>1)(1) RASIKBHAI B GHELANI (2) RAJUBHAI B GHELANI (3) DHARMESHBHAI G GHELANI (ALL PARTNERS ARE ADULTS AND INDIAN NATIONALS) PARTNER OF SOHAM TECHNOCAST (INDIAN PARTNERSHIP FIRM) HAVING PLACE OF BUSINESS AT: 4, PATEL NAGAR, 80 FEET ROAD, RAJKOT-GUJARAT (INDIA)</b>		
<b>DATE OF REGISTRATION</b>	12/04/2013	
<b>TITLE</b>	HANDLE	
<b>PRIORITY NA</b>		
<b>DESIGN NUMBER</b>	253756	
<b>CLASS</b>	08-06	
<b>1)ROYAL, AN INDIAN PARTNERSHIP FIRM AT C-2/314, G.I.D.C., SHANKER TEKARI UDYOG NAGAR, JAMNAGAR-361004, GUJARAT, (INDIA) WHOSE PARTNERS ARE AMRUTLAL SAMAT HARIA, AMRUTLAL NARSHI KHIMASIA AND SARLABEN SAVLA, ALL INDIAN OF ABOVE ADDRESS</b>		
<b>DATE OF REGISTRATION</b>	07/05/2013	
<b>TITLE</b>	BOLT	
<b>PRIORITY NA</b>		
<b>DESIGN NUMBER</b>	248176	
<b>CLASS</b>	09-03	
<b>1)SHRI MAA DISTRIBUTIONS INDIA PVT. LTD., AN INDIAN COMPANY INCORPORATED UNDER THE INDIAN COMPANIES ACT, 1956, HAVING ITS ADDRESS AT 1107, HEMKUNT HOUSE, 6 RAJENDRA PLACE, DELHI-110008, INDIA</b>		
<b>DATE OF REGISTRATION</b>	25/09/2012	
<b>TITLE</b>	CHOCOLATE PACKAGING BOX	
<b>PRIORITY NA</b>		

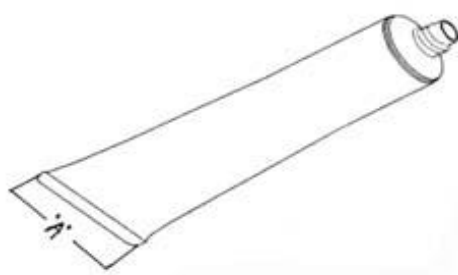
<b>DESIGN NUMBER</b>	248366	
<b>CLASS</b>	09-05	
<b>1)RAJENDRA KRISHNA PATIL, OF RAMAKRISHNA MISSION VIVEKANANDA UNIVERSITY, P.O.: BELUR MATH, HOWRAH-711202, WEST BENGAL, INDIA, OF THE ABOVE ADDRESS</b>		
<b>DATE OF REGISTRATION</b>	28/09/2012	
<b>TITLE</b>	TUBE	
<b>PRIORITY NA</b>		

<b>DESIGN NUMBER</b>	252731
<b>CLASS</b>	12-11
<b>1)JAGOTA INDUSTRIES, 439, INDL. AREA-B, LUDHIANA-141003 (PUNJAB) INDIA AN INDIAN PROPRIETORSHIP FIRM WHOSE PROPRIETOR IS:- ANIL JAGOTA BEING INDIAN NATIONALS OF THE ABOVE ADDRESS</b>	
<b>DATE OF REGISTRATION</b>	01/04/2013
<b>TITLE</b>	BASKET FOR BICYCLE
<b>PRIORITY NA</b>	



<b>DESIGN NUMBER</b>	252806
<b>CLASS</b>	07-01
<b>1)MA DESIGN INDIA PRIVATE LIMITED, A COMPANY INCORPORATED IN INDIA HAVING ITS PRINCIPAL PLACE OF BUSINESS AT A-41, SECTOR-80, PHASE-II, NOIDA-201305, U.P. INDIA</b>	
<b>DATE OF REGISTRATION</b>	03/04/2013
<b>TITLE</b>	DISH
<b>PRIORITY NA</b>	



<b>DESIGN NUMBER</b>	252856	
<b>CLASS</b>	10-01	
<b>1)AJANTA LIMITED, AN INDIAN COMPANY OF</b> ORPAT INDUSTRIAL ESTATE, RAJKOT-MORBI HIGHWAY, MORBI 363641, STATE OF GUJARAT, INDIA		
<b>DATE OF REGISTRATION</b>	03/04/2013	
<b>TITLE</b>	CLOCK	
<b>PRIORITY NA</b>		
<b>DESIGN NUMBER</b>	252873	
<b>CLASS</b>	10-01	
<b>1)AJANTA LIMITED, AN INDIAN COMPANY OF</b> ORPAT INDUSTRIAL ESTATE, RAJKOT-MORBI HIGHWAY, MORBI 363641, STATE OF GUJARAT, INDIA		
<b>DATE OF REGISTRATION</b>	03/04/2013	
<b>TITLE</b>	CLOCK	
<b>PRIORITY NA</b>		
<b>DESIGN NUMBER</b>	241329	
<b>CLASS</b>	13-02	
<b>1)CROMPTON GREAVES LIMITED</b> AVANTHA HOUSE, DR. ANNIE BESANIE BESANT ROAD, WORLI, MUMBAI-400030, MAHARASHTRA, INDIA		
<b>DATE OF REGISTRATION</b>	08/12/2011	
<b>TITLE</b>	TRANSFORMER	
<b>PRIORITY NA</b>		



<b>DESIGN NUMBER</b>	247808	
<b>CLASS</b>	23-02	
1)HANSGROHE SE, OF AUESTR. 5-9, D-77761 SCHILTACH, GERMANY, A GERMAN COMPANY		
<b>DATE OF REGISTRATION</b>	10/09/2012	
<b>TITLE</b>	BATHROOM HOLDER/HOOK	
<b>PRIORITY</b>		
<b>PRIORITY NUMBER</b>	<b>DATE</b>	<b>COUNTRY</b>
001318273-0019	16/03/2012	OHIM





<b>DESIGN NUMBER</b>	253229	
<b>CLASS</b>	12-16	
1)MINDA INDUSTRIES LIMITED., AN INDIAN COMPANY OF VILL. NAWADA FATEPUR, P.O. SIKANDERPUR BADDA, MANESAR, DISTT. GURGAON, HARYANA-122004, INDIA		
<b>DATE OF REGISTRATION</b>	18/04/2013	
<b>TITLE</b>	MODULAR SWITCH FOR VEHICLE	
<b>PRIORITY NA</b>		



<b>DESIGN NUMBER</b>	253289	
<b>CLASS</b>	07-01	
1)K & LAB CO., LTD., 4FL., POLIKEM BLDG., GWANYANG-DONG, 374, SIMIN-DAERO ANYANG SI DONGAN-GU, GYEONGGI-DO, 431-804, REPUBLIC OF KOREA, NATIONALITY: REPUBLIC OF KOREA		
<b>DATE OF REGISTRATION</b>	22/04/2013	
<b>TITLE</b>	LID OF CUP	
<b>PRIORITY</b>		
<b>PRIORITY NUMBER</b>	<b>DATE</b>	<b>COUNTRY</b>
30-2012-0050881	25/10/2012	REPUBLIC OF KOREA

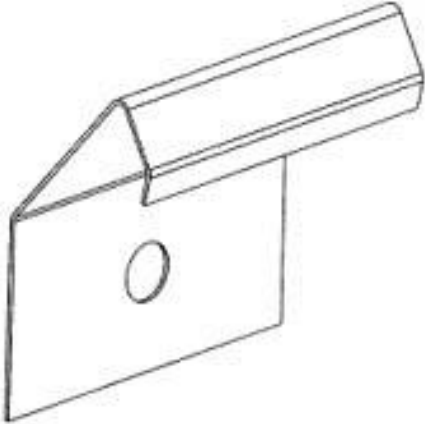

<b>DESIGN NUMBER</b>	251530	
<b>CLASS</b>	12-11	
<b>1)BAJAJ AUTO LIMITED, AN INDIAN COMPANY, INCORPORATED UNDER THE COMPANIES ACT OF 1956, HAVING ITS PRINCIPAL PLACE OF BUSINESS AT NEW 2ND &amp; 3RD FLOOR, KHIVRAJ BUILDING, NO. 616, ANNASALAI, CHENNAI - 600006, STATE OF TAMIL NADU, INDIA, AND REGISTERED OFFICE AT AKURDI, PUNE-411035, STATE OF MAHARASHTRA, INDIA</b>		
<b>DATE OF REGISTRATION</b>	08/02/2013	
<b>TITLE</b>	TAIL LAMP FOR MOTORCYCLE	
<b>PRIORITY NA</b>		
<b>DESIGN NUMBER</b>	251538	
<b>CLASS</b>	12-11	
<b>1)BAJAJ AUTO LIMITED, AN INDIAN COMPANY, INCORPORATED UNDER THE COMPANIES ACT OF 1956, HAVING ITS PRINCIPAL PLACE OF BUSINESS AT NEW 2ND &amp; 3RD FLOOR, KHIVRAJ BUILDING, NO. 616, ANNASALAI, CHENNAI - 600006, STATE OF TAMIL NADU, INDIA, AND REGISTERED OFFICE AT AKURDI, PUNE-411035, STATE OF MAHARASHTRA, INDIA</b>		
<b>DATE OF REGISTRATION</b>	08/02/2013	
<b>TITLE</b>	SIDE FAIRING MESH FOR MOTORCYCLE	
<b>PRIORITY NA</b>		
<b>DESIGN NUMBER</b>	251682	
<b>CLASS</b>	08-08	
<b>1)NEW ERA INDUSTRIES, A PARTNERSHIP FIRM WITH MR. AMAN KHANNA AND MRS. MANJU KHANNA OF PLOT NO. 333, SHOKEEN COMMERCIAL COMPLEX, I.G.N.O.U ROAD, NEB SARAI, NEW DELHI-110068</b>		
<b>DATE OF REGISTRATION</b>	14/02/2013	
<b>TITLE</b>	MOUNTING CLIP	
<b>PRIORITY NA</b>		

<b>DESIGN NUMBER</b>	248491		
<b>CLASS</b>	14-03		
<b>1)RADMOR S.A.; A COMPANY INCORPORATED UNDER THE LAWS OF POLAND; ADDRESS</b> AT, HUTNICZA STR., NO 3, 81-212 GDYNIA, POLAND			
<b>DATE OF REGISTRATION</b>	08/10/2012		
<b>TITLE</b>	HOUSING OF RADIOTELEPHONE		
<b>PRIORITY</b>			
<b>PRIORITY NUMBER</b>	<b>DATE</b>	<b>COUNTRY</b>	
001339501	13/08/2012	OHIM	
<b>DESIGN NUMBER</b>	252979		
<b>CLASS</b>	28-03		
<b>1)B. R. PLASTICS, AN INDIAN PARTNERSHIP FIRM, WHOSE OFFICE AT 59, 3RD BHOIWADA, BHULESHWAR, MUMBAI-400002, MAHARASHTRA, INDIA AND FACTORY AT 314, A TO Z INDUSTRIAL ESTATE, 3RD FLOOR, G. KADAM MARG, MUMBAI-400013, MAHARASHTRA, INDIA, WHOSE PARTNERS ARE</b> SURENDRA RAMANLAL SHAH, RAJESH RAMANLAL SHAH, UDAY RAMANLAL SHAH AND PARAG SURENDRA SHAH, ALL INDIANS AND ALL BEING PARTNERS AND OF ABOVE ADDRESS			
<b>DATE OF REGISTRATION</b>	09/04/2013		
<b>TITLE</b>	COMB		
<b>PRIORITY NA</b>			
<b>DESIGN NUMBER</b>	253062		
<b>CLASS</b>	05-05		
<b>1)M/S. BIBA APPARELS PRIVATE LIMITED, AN INDIAN PRIVATE LIMITED COMPANY INCORPORATED UNDER THE PROVISION OF THE COMPANIES ACT, 1956, AND HAVING ITS'S REGISTERED OFFICE AT</b> RELIABLE HOUSE, SITUATED AT HANUMAN SILK MILL COMPOUND, KANJURMARG (WEST), OPP. HUMA MALL, MUMBAI-400078 MAHARASHTRA, INDIA			
<b>DATE OF REGISTRATION</b>	11/04/2013		
<b>TITLE</b>	TEXTILE FABRIC		
<b>PRIORITY NA</b>			

<b>DESIGN NUMBER</b>	253118	
<b>CLASS</b>	08-06	
<b>1)VIMALBHAI CHANDUBHAI SHINGALA (INDIAN NATIONALS) PROPRIETOR OF ROCK INDUSTRIES (INDIAN PROPRIETORSHIP CONCERN) HAVING PLACE OF BUSINESS AT-</b> B/H. BALAJI PETROL PUMP, 80 FEET ROAD, SORATHIYAWADI, RAJKOT - 360002, GUJARAT (INDIA)		
<b>DATE OF REGISTRATION</b>	12/04/2013	
<b>TITLE</b>	HANDLE	
<b>PRIORITY NA</b>		

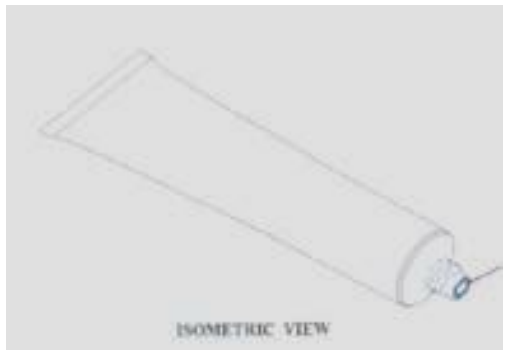
<b>DESIGN NUMBER</b>	248364	
<b>CLASS</b>	09-05	
<b>1)RAJENDRA KRISHNA PATIL, OF RAMAKRISHNA MISSION VIVEKANANDA UNIVERSITY, P.O.: BELUR MATH, HOWRAH-711202, WEST BENGAL, INDIA, OF THE ABOVE ADDRESS</b>		
<b>DATE OF REGISTRATION</b>	28/09/2012	
<b>TITLE</b>	TUBE	
<b>PRIORITY NA</b>		

<b>DESIGN NUMBER</b>	252823	
<b>CLASS</b>	09-07	
<b>1)RECKITT BENCKISER N. V., A DUTCH COMPANY OF SIRIUSDREEF 14, 2132 WT HOOFFDORP, NETHERLANDS</b>		
<b>DATE OF REGISTRATION</b>	03/04/2013	
<b>TITLE</b>	CAP	
<b>PRIORITY</b>		
<b>PRIORITY NUMBER</b>	<b>DATE</b>	<b>COUNTRY</b>
002115147	08/10/2012	OHIM

<b>DESIGN NUMBER</b>	252879	
<b>CLASS</b>	10-01	
<b>1)AJANTA LIMITED, AN INDIAN COMPANY OF ORPAT INDUSTRIAL ESTATE, RAJKOT-MORBI HIGHWAY, MORBI 363641, STATE OF GUJARAT, INDIA</b>		
<b>DATE OF REGISTRATION</b>	03/04/2013	
<b>TITLE</b>	CLOCK	
<b>PRIORITY NA</b>		

<b>DESIGN NUMBER</b>	253430	
<b>CLASS</b>	09-07	
<b>1)K &amp; LAB CO., LTD., 4FL., POLIKEM BLDG., GWANYANG-DONG, 374, SIMIN-DAERO ANYANG SI DONGAN-GU, GYEONGGI-DO, 431-804, REPUBLIC OF KOREA, NATIONALITY: REPUBLIC OF KOREA</b>		
<b>DATE OF REGISTRATION</b>	25/04/2013	
<b>TITLE</b>	LID OF CUP	
<b>PRIORITY</b>		
<b>PRIORITY NUMBER</b>	<b>DATE</b>	<b>COUNTRY</b>
30-2012-0060428	14/12/2012	REPUBLIC OF KOREA

<b>DESIGN NUMBER</b>	248063	
<b>CLASS</b>	13-03	
<b>1)GELCO ELECTRONICS PVT. LTD., A COMPANY INCORPORATED UNDER THE INDIAN COMPANIES ACT, HAVING ITS ADDRESS AT, 6, 7, &amp; 8, AMARNATH ESTATE, NR. KRISHNA GOPAL ESTATE, NARODA ROAD, AHMEDABAD-380025, GUJARAT STATE, INDIA</b>		
<b>DATE OF REGISTRATION</b>	19/09/2012	
<b>TITLE</b>	BOX FOR ELECTRONICS DEVICE	
<b>PRIORITY NA</b>		

<b>DESIGN NUMBER</b>	250594	
<b>CLASS</b>	13-03	
<b>1)TYCO ELECTRONICS NEDERLAND B.V., A DUTCH COMPANY, OF RIETVELDENWEG 32, AR'S HERTOGENBOSCH 5222, NETHERLANDS</b>		
<b>DATE OF REGISTRATION</b>	02/01/2013	
<b>TITLE</b>	MOUNTING FOR SUPPORTING A CABLE SPLITTER	
<b>PRIORITY</b>		
<b>PRIORITY NUMBER</b>	<b>DATE</b>	<b>COUNTRY</b>
002072330	11/07/2012	OHIM

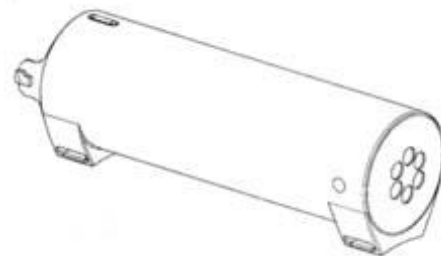

<b>DESIGN NUMBER</b>	253223	
<b>CLASS</b>	12-16	
<b>1)WHEELS INDIA LIMITED, HAVING PLACE OF BUSINESS AT PADI, CHENNAI-600050, TAMILNADU, NATIONALITY OF INDIAN</b>		
<b>DATE OF REGISTRATION</b>	18/04/2013	
<b>TITLE</b>	WHEEL RIM FOR VEHICLES	
<b>PRIORITY NA</b>		





<b>DESIGN NUMBER</b>	251499	
<b>CLASS</b>	09-03	
<b>1)ACCESS BUSINESS GROUP INTERNATIONAL LLC, 7575 FULTON STREET EAST, ADA, MICHIGAN 49355, U.S.A., A MICHIGAN LIMITED LIABILITY COMPANY, U.S.A.</b>		
<b>DATE OF REGISTRATION</b>	07/02/2013	
<b>TITLE</b>	CONTAINER	
<b>PRIORITY</b>		
<b>PRIORITY NUMBER</b>	<b>DATE</b>	<b>COUNTRY</b>
29/430,189	22/08/2012	U.S.A.



<b>DESIGN NUMBER</b>	251533	
<b>CLASS</b>	12-11	
<b>1)BAJAJ AUTO LIMITED, AN INDIAN COMPANY, INCORPORATED UNDER THE COMPANIES ACT OF 1956, HAVING ITS PRINCIPAL PLACE OF BUSINESS AT NEW 2ND &amp; 3RD FLOOR, KHIVRAJ BUILDING, NO. 616, ANNASALAI, CHENNAI - 600006, STATE OF TAMIL NADU, INDIA, AND REGISTERED OFFICE AT AKURDI, PUNE-411035, STATE OF MAHARASHTRA, INDIA</b>		
<b>DATE OF REGISTRATION</b>	08/02/2013	
<b>TITLE</b>	BRACKET UPPER FOR MOTORCYCLE	
<b>PRIORITY NA</b>		

<b>DESIGN NUMBER</b>	248526	
<b>CLASS</b>	13-01	
<b>1)WE, WOBLEN PROPERTIES GMBH, A CORPORATION ORGANIZED AND EXISTING UNDER THE LAWS OF GERMANY, OF DREEKAMP 5, 26605 AURICH, GERMANY</b>		
<b>DATE OF REGISTRATION</b>	10/10/2012	
<b>TITLE</b>	ROTOR BLADE FOR WIND TURBINE	
<b>PRIORITY</b>		
<b>PRIORITY NUMBER</b>	<b>DATE</b>	<b>COUNTRY</b>
002 023 564-0001	11/04/2012	OHIM

<b>DESIGN NUMBER</b>	250832	
<b>CLASS</b>	08-08	
<b>1)(1). BANKIMBHAI VELJIBHAI MANVAR, (2) ALPESHBHAI HASMUKHBHAI PARIKH (3) VINESHBHAI RATILAL DADHANIYA (4). MITKUMAR KISHORBHAI DEPANI., ALL INDIAN NATIONAL PARTNERS OF M/S. BARRY CREATION., AN INDIAN PARTNERSHIP FIRM., HAVING ITS PRINCIPLE PLACE OF BUSINESS AT, 901, RAVI TOWER, OPP. PARIMAL SCHOOL, KALAWAD ROAD, RAJKOT-360004. GUJARAT-INDIA</b>		
<b>DATE OF REGISTRATION</b>	07/01/2013	
<b>TITLE</b>	CURTAIN FITTING	
<b>PRIORITY NA</b>		

<b>DESIGN NUMBER</b>	252939	
<b>CLASS</b>	21-01	
<b>1)DR. ING. H.C.F. PORSCHE AKTIENGESELLSCHAFT, A GERMAN COMPANY OF PORSCHEPLATZ 1, 70435 STUTTGART, GERMANY</b>		
<b>DATE OF REGISTRATION</b>	08/04/2013	
<b>TITLE</b>	TOY CAR	
<b>PRIORITY NA</b>		

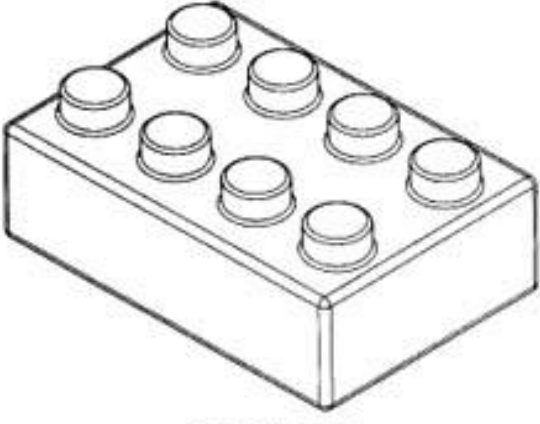
<b>DESIGN NUMBER</b>	252984	
<b>CLASS</b>	28-02	
<b>1)HINDUSTAN UNILEVER LIMITED, A COMPANY INCORPORATED UNDER THE INDIAN COMPANIES ACT, 1913, HAVING ITS REGISTERED OFFICE AT UNILEVER HOUSE, B. D. SAWANT MARG, CHAKALA, ANDHERI (EAST), MUMBAI 400099, STATE OF MAHARASHTRA, INDIA</b>		
<b>DATE OF REGISTRATION</b>	09/04/2013	
<b>TITLE</b>	SOAP BAR	
<b>PRIORITY</b>		
<b>PRIORITY NUMBER</b>	<b>DATE</b>	<b>COUNTRY</b>
002119925-0001	17/10/2012	OHIM

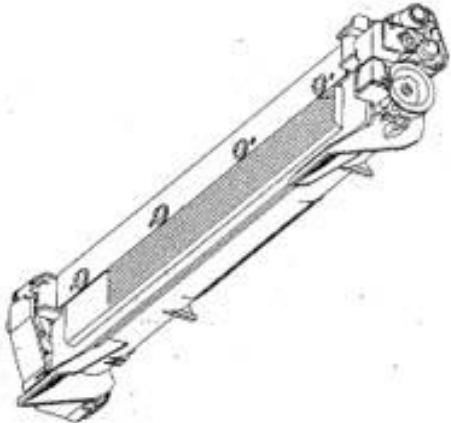
<b>DESIGN NUMBER</b>	252694	
<b>CLASS</b>	14-02	
<b>1)BROTHER INDUSTRIES LTD., A CORPORATION ORGANIZED AND EXISTING UNDER THE LAWS OF JAPAN, 15-1, NAESHIRO-CHO, MIZUHO-KU, NAGOYA-SHI, AICHI-KEN, JAPAN</b>		
<b>DATE OF REGISTRATION</b>	28/03/2013	
<b>TITLE</b>	TONER CARTRIDGE	
<b>PRIORITY</b>		
<b>PRIORITY NUMBER</b>	<b>DATE</b>	<b>COUNTRY</b>
2012-028325	20/11/2012	JAPAN



<b>DESIGN NUMBER</b>	252732
<b>CLASS</b>	13-03
<b>1)O. BHOLARAM, PROPRIETOR OF: M/S. CHOICE INDUSTRIES, INDIAN NATIONAL, CARRYING ON BUSINESS AT NO.40/1, MUNIAPPAN STREET, KONDITHOPE, CHENNAI-600079 INDIA</b>	
<b>DATE OF REGISTRATION</b>	01/04/2013
<b>TITLE</b>	POWER EXTENSION SOCKET
<b>PRIORITY NA</b>	



<b>DESIGN NUMBER</b>	252743
<b>CLASS</b>	08-06
<b>1)PARESHBHAI JERAMBHAI KHUAT (INDIAN NATIONAL) SOLE PROPRIETOR OF SHREE BALAJI STEEL (INDIAN PROPRIETORSHIP CONCERN) HAVING PLACE OF BUSINESS AT- 8/3, VANITYAWADI, KHODIYAR KRUPA, RAJKOT-360002 GUJARAT (INDIA)</b>	
<b>DATE OF REGISTRATION</b>	02/04/2013
<b>TITLE</b>	HANDLE
<b>PRIORITY NA</b>	



<b>DESIGN NUMBER</b>	252763
<b>CLASS</b>	07-02
<b>1)KUBER CHAMPALALJI BAMBOLI 3/404, RISHABH MANSION, JAWAHAR NAGAR, S. V. ROAD, GOREGAON (W), MUMBAI-400062. INDIAN NATIONAL STATE OF MAHARASHTRA INDIA, AN INDIAN OF THE ABOVE ADDRESS</b>	
<b>DATE OF REGISTRATION</b>	02/04/2013
<b>TITLE</b>	CASSEROLE



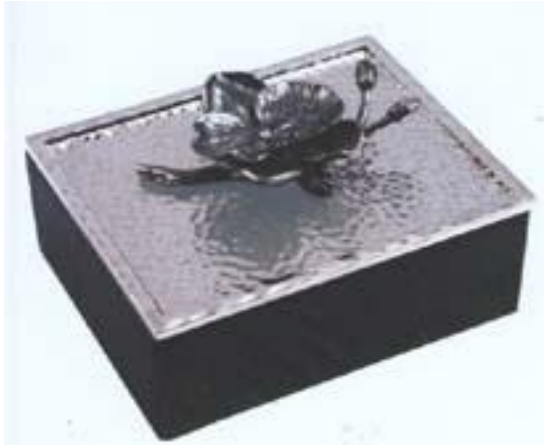

<b>PRIORITY NA</b>	
--------------------	--

<b>DESIGN NUMBER</b>	252807	
<b>CLASS</b>	11-02	
<b>1)MA DESIGN INDIA PRIVATE LIMITED, A COMPANY INCORPORATED IN INDIA HAVING ITS PRINCIPAL PLACE OF BUSINESS</b> AT A-41, SECTOR-80, PHASE-II, NOIDA-201305, U.P. INDIA		
<b>DATE OF REGISTRATION</b>	03/04/2013	
<b>TITLE</b>	BOX (FOR JEWELLERY)	
<b>PRIORITY NA</b>		

<b>DESIGN NUMBER</b>	252874	
<b>CLASS</b>	10-01	
<b>1)AJANTA LIMITED, AN INDIAN COMPANY OF</b> ORPAT INDUSTRIAL ESTATE, RAJKOT-MORBI HIGHWAY, MORBI 363641, STATE OF GUJARAT, INDIA		
<b>DATE OF REGISTRATION</b>	03/04/2013	
<b>TITLE</b>	CLOCK	
<b>PRIORITY NA</b>		

<b>DESIGN NUMBER</b>	253209	
<b>CLASS</b>	09-99	
<b>1)MEDELA HOLDING AG,</b> LÄTTICHSTRASSE 4 B, 6340 BAAR, SWITZERLAND, A SWISS COMPANY		
<b>DATE OF REGISTRATION</b>	17/04/2013	
<b>TITLE</b>	PACKAGE FOR A TEAT OF A FEEDING BOTTLE	
<b>PRIORITY</b>		
<b>PRIORITY NUMBER</b>	<b>DATE</b>	<b>COUNTRY</b>
698171001	18/10/2012	WIPO

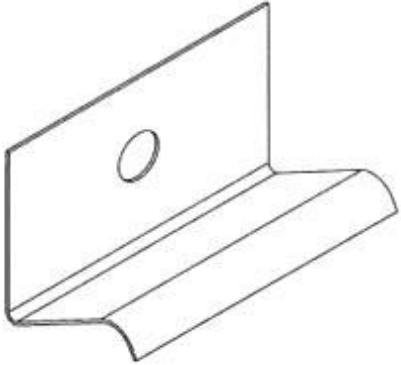
<b>DESIGN NUMBER</b>	241328	
<b>CLASS</b>	13-02	
<b>1)CROMPTON GREAVES LIMITED</b> AVANTHA HOUSE, DR. ANNIE BESANIE BESANT ROAD, WORLI, MUMBAI-400030, MAHARASHTRA, INDIA		
<b>DATE OF REGISTRATION</b>	08/12/2011	
<b>TITLE</b>	TRANSFORMER	
<b>PRIORITY NA</b>		
<b>DESIGN NUMBER</b>	252591	
<b>CLASS</b>	30-01	
<b>1)NAVEEN KOHLI PROPRIETOR OF SHIVAM POLYMERS, AN INDIAN CITIZEN, OF</b> B-16 SITE B, SURAJPUR INDUSTRIAL AREA, GREATER NOIDA-201306, UP, INDIA		
<b>DATE OF REGISTRATION</b>	21/03/2013	
<b>TITLE</b>	BOOT FOR HORSES	
<b>PRIORITY NA</b>		
<b>DESIGN NUMBER</b>	251513	
<b>CLASS</b>	12-11	
<b>1)BAJAJ AUTO LIMITED, AN INDIAN COMPANY, INCORPORATED UNDER THE COMPANIES ACT OF 1956, HAVING ITS PRINCIPAL PLACE OF BUSINESS AT NEW 2ND &amp; 3RD FLOOR, KHIVRAJ BUILDING, NO. 616, ANNASALAI, CHENNAI - 600006, STATE OF TAMIL NADU, INDIA,</b> AND REGISTERED OFFICE AT AKURDI, PUNE-411035, STATE OF MAHARASHTRA, INDIA		
<b>DATE OF REGISTRATION</b>	08/02/2013	
<b>TITLE</b>	PANEL ASSEMBLY FOR MOTORCYCLE	
<b>PRIORITY NA</b>		

<b>DESIGN NUMBER</b>	251681	
<b>CLASS</b>	08-08	
<b>1)NEW ERA INDUSTRIES, A PARTNERSHIP FIRM WITH MR. AMAN KHANNA AND MRS. MANJU KHANNA OF PLOT NO. 333, SHOKEEN COMMERCIAL COMPLEX, I.G.N.O.U ROAD, NEB SARAI, NEW DELHI-110068</b>		
<b>DATE OF REGISTRATION</b>	14/02/2013	
<b>TITLE</b>	MOUNTING CLIP	
<b>PRIORITY NA</b>		
<b>DESIGN NUMBER</b>	250883	
<b>CLASS</b>	09-01	
<b>1)BHARAT BHUSHAN (PROPRIETOR), NATIONALITY INDIAN TRADING AS HANS HERBAL OVERSEAS (INDIA)(PROPRIETORSHIP FIRM) WHOSE ADDRESS IS K. NO-158, RITHALA IND. ESTATE, NEW DELHI-110085</b>		
<b>DATE OF REGISTRATION</b>	09/01/2013	
<b>TITLE</b>	BOTTLE	
<b>PRIORITY NA</b>		
<b>DESIGN NUMBER</b>	252978	
<b>CLASS</b>	28-03	
<b>1)B. R. PLASTICS, AN INDIAN PARTNERSHIP FIRM, WHOSE OFFICE AT 59, 3RD BHOIWADA, BHULESHWAR, MUMBAI-400002, MAHARASHTRA, INDIA AND FACTORY AT 314, A TO Z INDUSTRIAL ESTATE, 3RD FLOOR, G. KADAM MARG, MUMBAI-400013, MAHARASHTRA, INDIA, WHOSE PARTNERS ARE SURENDRA RAMANLAL SHAH, RAJESH RAMANLAL SHAH, UDAY RAMANLAL SHAH AND PARAG SURENDRA SHAH, ALL INDIANS AND ALL BEING PARTNERS AND OF ABOVE ADDRESS</b>		
<b>DATE OF REGISTRATION</b>	09/04/2013	
<b>TITLE</b>	COMB	
<b>PRIORITY NA</b>		

<b>DESIGN NUMBER</b>	253117	
<b>CLASS</b>	08-06	
<b>1) VIMALBHAI CHANDUBHAI SHINGALA (INDIAN NATIONALS) PROPRIETOR OF ROCK INDUSTRIES (INDIAN PROPRIETORSHIP CONCERN) HAVING PLACE OF BUSINESS AT-</b> B/H. BALAJI PETROL PUMP, 80 FEET ROAD, SORATHIYAWADI, RAJKOT - 360002, GUJARAT (INDIA)		
<b>DATE OF REGISTRATION</b>	12/04/2013	
<b>TITLE</b>	HANDLE	
<b>PRIORITY NA</b>		

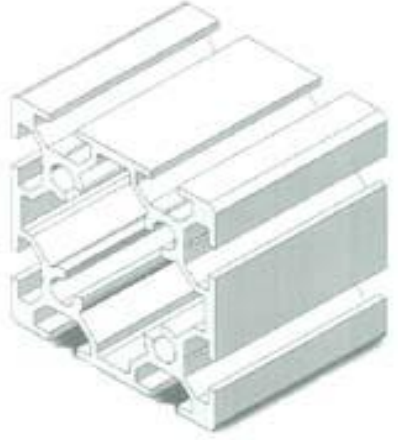
<b>DESIGN NUMBER</b>	240880	
<b>CLASS</b>	25-02	
<b>1) MISUMI INDIA PRIVATE LIMITED</b> 4TH FLOOR, KUMAR BUSINESS CENTRE, BUNDGARDEN ROAD, PUNE-411001., MAHARASHTRA, INDIA.		
<b>DATE OF REGISTRATION</b>	23/11/2011	
<b>TITLE</b>	EXTRUSION	
<b>PRIORITY NA</b>		

<b>DESIGN NUMBER</b>	251913		
<b>CLASS</b>	31-00		
<b>1) KONINKLIJKE PHILIPS ELECTRONICS N.V., A COMPANY ORGANIZED AND EXISTING UNDER THE LAWS OF THE KINGDOM OF THE NETHERLANDS, RESIDING AT</b> EINDHOVEN, WHOSE POST-OFFICE ADDRESS IS HIGH TECH CAMPUS 5, 5656 AE EINDHOVEN, THE NETHERLANDS			
<b>DATE OF REGISTRATION</b>	27/02/2013		
<b>TITLE</b>	BLENDER		
<b>PRIORITY</b>			
<b>PRIORITY NUMBER</b>	<b>DATE</b>	<b>COUNTRY</b>	
002095026-0001	30/08/2012	OHIM	
<b>PRIORITY NA</b>			

<b>DESIGN NUMBER</b>	252819	
<b>CLASS</b>	16-06	
<b>1)MA DESIGN INDIA PRIVATE LIMITED, A COMPANY INCORPORATED IN INDIA HAVING ITS PRINCIPAL PLACE OF BUSINESS</b> AT A-41, SECTOR-80, PHASE-II, NOIDA-201305, U.P. INDIA		
<b>DATE OF REGISTRATION</b>	03/04/2013	
<b>TITLE</b>	MAGNIFYING GLASS	
<b>PRIORITY NA</b>		
<b>DESIGN NUMBER</b>	252869	
<b>CLASS</b>	10-01	
<b>1)AJANTA LIMITED, AN INDIAN COMPANY OF</b> ORPAT INDUSTRIAL ESTATE, RAJKOT-MORBI HIGHWAY, MORBI 363641, STATE OF GUJARAT, INDIA		
<b>DATE OF REGISTRATION</b>	03/04/2013	
<b>TITLE</b>	CLOCK	
<b>PRIORITY NA</b>		
<b>DESIGN NUMBER</b>	252878	
<b>CLASS</b>	10-01	
<b>1)AJANTA LIMITED, AN INDIAN COMPANY OF</b> ORPAT INDUSTRIAL ESTATE, RAJKOT-MORBI HIGHWAY, MORBI 363641, STATE OF GUJARAT, INDIA		
<b>DATE OF REGISTRATION</b>	03/04/2013	
<b>TITLE</b>	CLOCK	
<b>PRIORITY NA</b>		

<b>DESIGN NUMBER</b>	252889	
<b>CLASS</b>	10-01	
<b>1)AJANTA LIMITED, AN INDIAN COMPANY OF</b> ORPAT INDUSTRIAL ESTATE, RAJKOT-MORBI HIGHWAY, MORBI 363641, STATE OF GUJARAT, INDIA		
<b>DATE OF REGISTRATION</b>	03/04/2013	
<b>TITLE</b>	CLOCK	
<b>PRIORITY NA</b>		
<b>DESIGN NUMBER</b>	253491	
<b>CLASS</b>	15-07	
<b>1)LOKE KEE VOON,</b> 98-E, MERGONG INDUSTRIAL ESTATE, SEBERANG JALAN PUTRA, 05150 ALOR STAR, KEDAH, MALAYSIA, A NATIONAL OF MALAYSIA		
<b>DATE OF REGISTRATION</b>	29/04/2013	
<b>TITLE</b>	FREEZER PLATE	
<b>PRIORITY NA</b>		
<b>DESIGN NUMBER</b>	251455	
<b>CLASS</b>	21-02	
<b>1)KETAN MOHANLAL SHETH SOLE PROPRIETOR OF SHETH</b> <b>ENTERPRISE OF</b> 3, SHANTA BHAVAN C.H.S., ST. XAVIER'S ROAD, VILE PARLE (WEST), MUMBAI-400 056, MAHARASHTRA, INDIA, INDIAN NATIONAL		
<b>DATE OF REGISTRATION</b>	06/02/2013	
<b>TITLE</b>	BALL	
<b>PRIORITY NA</b>		

<b>DESIGN NUMBER</b>	253206	
<b>CLASS</b>	07-02	
<b>1)LA TERMOPLASTIC F.B.M. S.R.L., A COMPANY ORGANIZED UNDER LAW OF THE ITALIAN REPUBLIC OF</b> VIA DEL TORNAGO Z.I.-I-21010 ARSAGO SEPRIO, VARESE, ITALY		
<b>DATE OF REGISTRATION</b>	17/04/2013	
<b>TITLE</b>	COOKWARE HANDLE	
<b>PRIORITY</b>		
<b>PRIORITY NUMBER</b>	<b>DATE</b>	<b>COUNTRY</b>
002120758	18/10/2012	OHIM



<b>DESIGN NUMBER</b>	253346	
<b>CLASS</b>	23-04	
<b>1)M/S. ORIENT ELECTRICALS (A DIVISION OF ORIENT PAPER &amp; INDUSTRIES LTD.),</b> 11, INDUSTRIAL ESTATE, SECTOR-6, FARIDABAD, HARYANA-121006		
<b>DATE OF REGISTRATION</b>	23/04/2013	
<b>TITLE</b>	CEILING FAN	
<b>PRIORITY NA</b>		





<b>DESIGN NUMBER</b>	251512	
<b>CLASS</b>	12-11	
<b>1)BAJAJ AUTO LIMITED, AN INDIAN COMPANY, INCORPORATED UNDER THE COMPANIES ACT OF 1956, HAVING ITS PRINCIPAL PLACE OF BUSINESS AT NEW 2ND &amp; 3RD FLOOR, KHIVRAJ BUILDING, NO. 616, ANNASALAI, CHENNAI - 600006, STATE OF TAMIL NADU, INDIA,</b> AND REGISTERED OFFICE AT AKURDI, PUNE-411035, STATE OF MAHARASHTRA, INDIA		
<b>DATE OF REGISTRATION</b>	08/02/2013	
<b>TITLE</b>	FLANGE SEAT COVER FOR MOTORCYCLE	
<b>PRIORITY NA</b>		





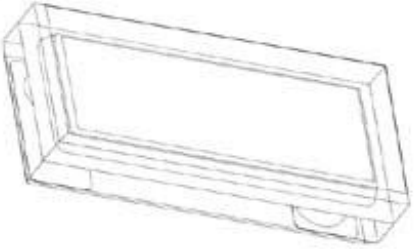

<b>DESIGN NUMBER</b>	251520	
<b>CLASS</b>	12-11	
1)BAJAJ AUTO LIMITED, AN INDIAN COMPANY, INCORPORATED UNDER THE COMPANIES ACT OF 1956, HAVING ITS PRINCIPAL PLACE OF BUSINESS AT NEW 2ND & 3RD FLOOR, KHIVRAJ BUILDING, NO. 616, ANNASALAI, CHENNAI - 600006, STATE OF TAMIL NADU, INDIA, AND REGISTERED OFFICE AT AKURDI, PUNE-411035, STATE OF MAHARASHTRA, INDIA		
<b>DATE OF REGISTRATION</b>	08/02/2013	
<b>TITLE</b>	HOLDER STEP FOR MOTORCYCLE	
<b>PRIORITY NA</b>		
<b>DESIGN NUMBER</b>	251680	
<b>CLASS</b>	08-08	
1)NEW ERA INDUSTRIES, A PARTNERSHIP FIRM WITH MR. AMAN KHANNA AND MRS. MANJU KHANNA OF PLOT NO. 333, SHOKEEN COMMERCIAL COMPLEX, I.G.N.O.U ROAD, NEB SARAI, NEW DELHI-110068		
<b>DATE OF REGISTRATION</b>	14/02/2013	
<b>TITLE</b>	MOUNTING CLIP	
<b>PRIORITY NA</b>		
<b>DESIGN NUMBER</b>	252956	
<b>CLASS</b>	02-04	
1)ALPINE POLYRUB PVT. LTD. A-20, MANGOLPURI INDUSTRIAL AREA, PHASE-II, DELHI-110034, INDIA. (AN INDIAN COMPANY DULY REGISTERED UNDER THE COMPANIES ACT, 1956)		
<b>DATE OF REGISTRATION</b>	08/04/2013	
<b>TITLE</b>	FOOTWEAR	
<b>PRIORITY NA</b>		

<b>DESIGN NUMBER</b>	253116		
<b>CLASS</b>	08-06		
<b>1)VIMALBHAI CHANDUBHAI SHINGALA (INDIAN NATIONALS) PROPRIETOR OF ROCK INDUSTRIES (INDIAN PROPRIETORSHIP CONCERN) HAVING PLACE OF BUSINESS AT- B/H. BALAJI PETROL PUMP, 80 FEET ROAD, SORATHIYAWADI, RAJKOT - 360002, GUJARAT (INDIA)</b>			
<b>DATE OF REGISTRATION</b>	12/04/2013		
<b>TITLE</b>	HANDLE		
<b>PRIORITY NA</b>			
<b>DESIGN NUMBER</b>	253712		
<b>CLASS</b>	09-07		
<b>1)MANIKA MOULDS PVT. LTD., A COMPANY INCORPORATED UNDER THE INDIAN COMPANIES ACT, AAR-PEE CENTRE, 601-605, 6TH FLOOR GUFFIC COMPOUND, MIDC, ANDHERI (E), MUMBAI-400093, MAHARASHTRA, INDIA</b>			
<b>DATE OF REGISTRATION</b>	07/05/2013		
<b>TITLE</b>	BATTERY LID		
<b>PRIORITY NA</b>			
<b>DESIGN NUMBER</b>	229085		
<b>CLASS</b>	10-07		
<b>1)SEIKO INSTRUMENTS INC., 8, NAKASE 1-CHOME, MIHAMA-KU, CHIBA-SHI, CHIBA, JAPAN</b>			
<b>DATE OF REGISTRATION</b>	04/05/2010		
<b>TITLE</b>	EQUIPMENT FOR PRODUCING ELECTRICAL SIGNAL		
<b>PRIORITY</b>			
<b>PRIORITY NUMBER</b>	<b>DATE</b>	<b>COUNTRY</b>	
2009-026034	06/11/2009	JAPAN	

<b>DESIGN NUMBER</b>	248263	
<b>CLASS</b>	08-06	
<b>1)MAHESHBHAI SHIVALALBHAI GAJERA AN INDIAN NATIONAL PROPRIETOR OF SHREE HARIKRUPA DIE CASTING AN INDIAN PROPRIETORSHIP FIRM HAVING ITS PRINCIPAL PLACE OF BUSINESS</b> AT K-1, 242/17, B/4 MEL-TECH, NEAR TURBO BEARING, AJI VASAHAAT GIDC, RAJKOT-360002, GUJARAT-INDIA		
<b>DATE OF REGISTRATION</b>	28/09/2012	
<b>TITLE</b>	HANDLE	
<b>PRIORITY NA</b>		
<b>DESIGN NUMBER</b>	252800	
<b>CLASS</b>	13-02	
<b>1)M/S ACTION BATTERIES PVT. LTD. (A COMPANY DULY REGISTERED UNDER THE COMPANY'S LAW) C-105, FOCAL POINT EXTENSION, JALANDHAR, PUNJAB, INDIA.</b> AN INDIAN COMPANY REGISTERED UNDER THE COMPANY'S LAW OF THE ABOVE ADDRESS		
<b>DATE OF REGISTRATION</b>	03/04/2013	
<b>TITLE</b>	TUBULAR SPINE FOR BATTERY	
<b>PRIORITY NA</b>		
<b>DESIGN NUMBER</b>	252818	
<b>CLASS</b>	07-03	
<b>1)MA DESIGN INDIA PRIVATE LIMITED, A COMPANY INCORPORATED IN INDIA HAVING ITS PRINCIPAL PLACE OF BUSINESS</b> AT A-41, SECTOR-80, PHASE-II, NOIDA-201305, U.P. INDIA		
<b>DATE OF REGISTRATION</b>	03/04/2013	
<b>TITLE</b>	CAKE SERVER	
<b>PRIORITY NA</b>		

<b>DESIGN NUMBER</b>	252868	
<b>CLASS</b>	10-01	
<b>1)AJANTA LIMITED, AN INDIAN COMPANY OF</b> ORPAT INDUSTRIAL ESTATE, RAJKOT-MORBI HIGHWAY, MORBI 363641, STATE OF GUJARAT, INDIA		
<b>DATE OF REGISTRATION</b>	03/04/2013	
<b>TITLE</b>	CLOCK	
<b>PRIORITY NA</b>		
<b>DESIGN NUMBER</b>	252877	
<b>CLASS</b>	10-01	
<b>1)AJANTA LIMITED, AN INDIAN COMPANY OF</b> ORPAT INDUSTRIAL ESTATE, RAJKOT-MORBI HIGHWAY, MORBI 363641, STATE OF GUJARAT, INDIA		
<b>DATE OF REGISTRATION</b>	03/04/2013	
<b>TITLE</b>	CLOCK	
<b>PRIORITY NA</b>		
<b>DESIGN NUMBER</b>	252225	
<b>CLASS</b>	23-01	
<b>1)MAHESH GUPTA, AN INDIAN NATIONAL OF</b> C-64, SECTOR - 14, NOIDA, UTTAR PRADESH, INDIA		
<b>DATE OF REGISTRATION</b>	08/03/2013	
<b>TITLE</b>	WATER PURIFIER	
<b>PRIORITY NA</b>		

<b>DESIGN NUMBER</b>	252431		
<b>CLASS</b>	19-06		
<b>1)FLAIR PENS LIMITED, AN INDIAN PARTNERSHIP FIRM OF</b> 63, B/C, GOVT. INDUSTRIAL ESTATE, CHARKOP, KANDIVALI (W), MUMBAI - 400067, MAHARASHTRA, INDIA			
<b>DATE OF REGISTRATION</b>	19/03/2013		
<b>TITLE</b>	PEN		
<b>PRIORITY NA</b>			
<b>DESIGN NUMBER</b>	253505		
<b>CLASS</b>	06-01		
<b>1)OKBABY S.R.L.,</b> VIA DEL LAVORO, 26, 24060 TELGATE (BERGAMO), ITALY, AN ITALIAN LIMITED LIABILITY COMPANY			
<b>DATE OF REGISTRATION</b>	29/04/2013		
<b>TITLE</b>	CHILDREN'S SEAT, FOR FIXING ON CYCLES		
<b>PRIORITY</b>			
<b>PRIORITY NUMBER</b>	<b>DATE</b>	<b>COUNTRY</b>	
002174607-0001	29/01/2013	OHIM	