

INTRODUCTION

In view of the recent amendment made in the Designs (Amendment) Rules, 2008 with effect from 17/06/2008, Publication of the matter relating to Designs is being published in the Official Journal of The Patent Office. This Journal is being published on weekly basis on every Friday covering the various proceedings on Designs as required according to the provisions of under Rule 22, 25, 27 and 39 of the Design (Amendment) Rules, 2008. All the enquiries on this Official Journal and other information as required by the public should be addressed to the Controller General of Patents, Designs & Trade Marks. Suggestions and comments are requested from all quarters so that the content can be enriched.

COPYRIGHT PUBLICATION

SL NO	CASE NUMBERS	RENEWED ON
1.	180216	21.10.2013
2.	191987	30.09.2013
3.	192219	03.10.2013
4.	192724	03.10.2013
5.	192797	30.09.2013
6.	192942	03.10.2013
7.	192943	03.10.2013
8.	193344	03.10.2013
9.	193345	03.10.2013
10.	193403	03.10.2013
11.	193967	03.10.2013
12.	194227	30.09.2013
13.	194271	30.09.2013
14.	203274	21.10.2013
15.	245594	30.09.2013
16.	245253	21.10.2013

THE DESIGNS ACT, 2000
SECTION 30
DESIGN ASSIGNMENT

The Design stands in the name of Kraft Foods Global Brands LLC registered under the Designs Act, 2000 has been assigned in the Register of Designs in the name as follows:-

Design No.	Class	Name
221386	01-01	KRAFT FOODS GROUP BRANDS LLC OF THREE LAKES DRIVE, NORTHFIELD, ILLINOIS, 60093, USA, A US CORPORATION



THE DESIGNS ACT 2000
SECTION 30
DESIGN ASSIGNMENT

The Design stands in the name of Lightweight Medical Limited registered under the Designs Act, 2000 has been assigned in the Register of Designs in the name as follows:-

Design No.	Class	Name
207564	24-01	EVAC+CHAIR INTERNATIONAL LIMITED, A UK REGISTERED COMPANY, OF PAR AID HOUSE, WESTON LANE, BIRMINGHAM, B11 3RS

REGISTRATION OF DESIGNS

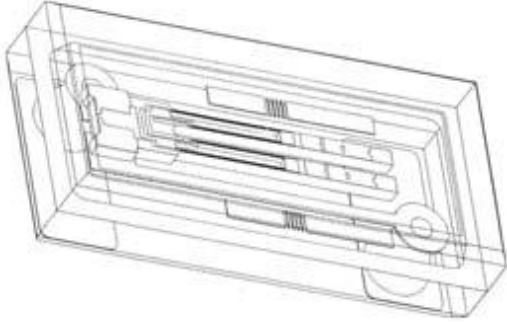

The following designs have been registered. They are now open for public inspection. In the following each entry the Date of Registration is shown. The Priority Number, Priority Date and Priority Country are also shown



DESIGN NUMBER	229082		
CLASS	10-07		
1)SEIKO INSTRUMENTS INC., 8, NAKASE 1-CHOME, MIHAMA-KU, CHIBA-SHI, CHIBA, JAPAN			
DATE OF REGISTRATION	04/05/2010		
TITLE	EQUIPMENT FOR PRODUCING ELECTRICAL SIGNAL		
PRIORITY			
PRIORITY NUMBER	DATE	COUNTRY	
2009-026019	06/11/2009	JAPAN	
DESIGN NUMBER	246444		
CLASS	09-01		
1)PEARL POLYMERS LIMITED, 204, ROHIT HOUSE, 3, TOLSTOY MARG, NEW DELHI-110001, INDIA, A COMPANY INCORPORATED UNDER THE COMPANIES ACT, 1956, OF THE ABOVE ADDRESS			
DATE OF REGISTRATION	10/07/2012		
TITLE	BOTTLE		
PRIORITY NA			
DESIGN NUMBER	248458		
CLASS	08-06		
1)SANVI ENTERPRISE, NATIONAL HIGH WAY 8-B, OPP. PARIN FURNITURE, KOTHARIYA SOLVENT AREA, NEAR DHOKIYA MOTORS, KOTHARIYA, DIST: RAJKOT-360004, GUJARAT, INDIA, INDIAN COMPANY			
DATE OF REGISTRATION	04/10/2012		
TITLE	HANDLE		
PRIORITY NA			

DESIGN NUMBER	253801	
CLASS	12-11	
1)TUBE INVESTMENTS OF INDIA LIMITED, AN INDIAN COMPANY INCORPORATED UNDER THE COMPANIES ACT OF 1956, HAVING ITS PRINCIPAL PLACE OF BUSINESS AT "DARE HOUSE", 234, N. S. C. BOSE ROAD, CHENNAI - 600001, STATE OF TAMIL NADU, INDIA		
DATE OF REGISTRATION	14/05/2013	
TITLE	FRAME FOR BICYCLE	
PRIORITY NA		

DESIGN NUMBER	246665	
CLASS	12-16	
1)MITSUBA CORPORATION, A JAPANESE CORPORATION, WHOSE ADDRESS IS 2681, HIROSAWACHO 1-CHOME, KIRYU-SHI, GUNMA 376-85555, JAPAN		
DATE OF REGISTRATION	23/07/2012	
TITLE	WINDSHIELD WIPER FOR VEHICLE	
PRIORITY NA		

DESIGN NUMBER	253434	
CLASS	12-11	
1)RAJU RUBBER INDUSTRIES OF INDUSTRIAL AREA 'C', JASPAL BANGAR ROAD, OPPOSITE SATYAM DHARAM KANDA, SUA ROAD, LUDHIANA-141010 (PUNJAB), INDIA, AN INDIAN PROPRIETORSHIP FIRM WHOSE PROPRIETRESS IS SMT. DARSHNA BANSAL		
DATE OF REGISTRATION	26/04/2013	
TITLE	RIM FOR BICYCLES	
PRIORITY NA		

DESIGN NUMBER	253526	
CLASS	13-03	
1)GOLD MEDAL ELECTRICALS PVT. LTD. A COMPANY REGISTERED UNDER COMPANY ACT 1956 WHOSE ADDRESS IS, A/302, KEMP PLAZA, MIND SPACE, OFF LINK ROAD, CHINCHOLI BUNDER, MALAD (WEST), MUMBAI-400064, MAHARASHTRA, INDIA		
DATE OF REGISTRATION	30/04/2013	
TITLE	SWITCH COVER PLATE	
PRIORITY NA		
DESIGN NUMBER	253550	
CLASS	14-99	
1)GOLD MEDAL ELECTRICALS PVT. LTD. A COMPANY REGISTERED UNDER COMPANY ACT 1956 WHOSE ADDRESS IS, A/302, KEMP PLAZA, MIND SPACE, OFF LINK ROAD, CHINCHOLI BUNDER, MALAD (WEST), MUMBAI-400064, MAHARASHTRA, INDIA		
DATE OF REGISTRATION	30/04/2013	
TITLE	DOOR BELL	
PRIORITY NA		
DESIGN NUMBER	251541	
CLASS	07-02	
1)SIDDHI INTERNATIONAL., (A PARTNERSHIP FIRM REGISTERED UNDER INDIAN PARTNERSHIP ACT, 1932), AT 35-A/12, BOMBAY TALKIES COMPOUND, 2ND FLOOR, NEAR ARUNA HOTEL, MALAD (WEST), MUMBAI-400064, MAHARASHTRA, INDIA. WHOSE PARTNERS ARE (1) VIREN SHAH. (INDIAN NATIONAL), (2) RAJESH MISTRY. (INDIAN NATIONAL), (3) AJAY MISTRI. (INDIAN NATIONAL), & (4) PRAJAY NARSANA. (INDIAN NATIONAL), ALL ARE HAVING ABOVE ADDRESS		
DATE OF REGISTRATION	08/02/2013	
TITLE	LID OF OIL DISPENSER	
PRIORITY NA		

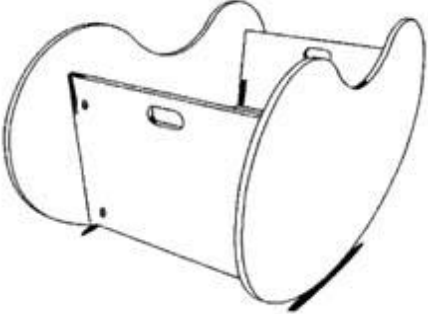
DESIGN NUMBER	251564	
CLASS	08-06	
1)PRASHANT SANCHANIYA, INDIAN NATIONALS, SOLE PROPRIETOR OF PMS ENTERPRISE, 15/16, SAMRAT INDUSTRIES AREA, BEHIND S.T. WORKSHOP, GONDAL ROAD, RAJKOT: 360004. GUJARAT (INDIA) ALL INDIAN OF ABOVE ADDRESS		
DATE OF REGISTRATION	11/02/2013	
TITLE	HANDLE	
PRIORITY NA		
DESIGN NUMBER	250554	
CLASS	08-07	
1)MAHINDRA 2 WHEELERS LIMITED, A COMPANY INCORPORATED UNDER THE INDIAN COMPANIES ACT, AT D1 BLOCK, PLOT NO. 18/2 (PART), MIDC, CHINCHWAD, PUNE-411019, MAHARASHTRA, INDIA		
DATE OF REGISTRATION	31/12/2012	
TITLE	KEY	
PRIORITY NA		
DESIGN NUMBER	252223	
CLASS	06-02	
1)1. RAHUL BHATT, AN INDIAN NATIONAL OF CS-2, OM SAKTI HERITAGE, IBLUR JUNCTION, BELLANDUR, BANGALORE-560103, AND 2. RAHUL JAIN, AN INDIAN NATIONAL OF 303 B, PARAMOUNT APARTMENTS, 4TH MAIN, GM PALYA, BANGALORE-560075		
DATE OF REGISTRATION	08/03/2013	
TITLE	CRADLE	
PRIORITY NA		

DESIGN NUMBER	248111	
CLASS	07-02	
1)NARENDIRAN REDDY SIMMACHALAM AT 12/379, 13TH CROSS STREET, PHASE- 1, SATHUVACHARI, VELLORE-632009		
DATE OF REGISTRATION	24/09/2012	
TITLE	COOKING PLATE	
PRIORITY NA		

DESIGN NUMBER	251198	
CLASS	23-04	
1)MITSUBISHI ELECTRIC CORPORATION, A JAPANESE COMPANY ORGANIZED AND EXISTING UNDER THE LAWS OF JAPAN, MANUFACTURERS AND MERCHANTS, OF THE ADDRESS 7-3, MARUNOUCHI 2-CHOME, CHIYODA-KU, TOKYO 100-8310, JAPAN		
DATE OF REGISTRATION	24/01/2013	
TITLE	AIR CONDITIONER	
PRIORITY		
PRIORITY NUMBER	DATE	COUNTRY
2012-018063	30/07/2012	JAPAN

DESIGN NUMBER	248895	
CLASS	07-01	
1)RAVISSANT PRIVATE LIMITED, AN INDIAN COMPANY, OF 50-51, COMMERCIAL COMPLEX, NEW FRIENDS COLONY, NEW DELHI-110065, INDIA		
DATE OF REGISTRATION	19/10/2012	
TITLE	PLATTER	
PRIORITY NA		

DESIGN NUMBER	250602
CLASS	12-08
1)MAN TRUCK & BUS AG, A GERMAN COMPANY OF DACHAUER STR. 667, 80995 MÜNICH, GERMANY	
DATE OF REGISTRATION	03/01/2013
TITLE	DRIVERS CAB OF A UTILITY VEHICLE

PRIORITY

PRIORITY NUMBER	DATE	COUNTRY
001335236	04/07/2012	OHIM



DESIGN NUMBER	250613
CLASS	12-08
1)MAN TRUCK & BUS AG, A GERMAN COMPANY OF DACHAUER STR. 667, 80995 MÜNICH, GERMANY	
DATE OF REGISTRATION	03/01/2013
TITLE	DRIVERS CAB OF A UTILITY VEHICLE

PRIORITY

PRIORITY NUMBER	DATE	COUNTRY
001335236	04/07/2012	OHIM

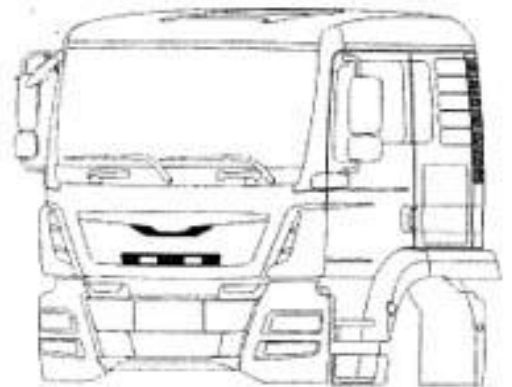







DESIGN NUMBER	250621
CLASS	12-08
1)MAN TRUCK & BUS AG, A GERMAN COMPANY OF DACHAUER STR. 667, 80995 MUNICH, GERMANY	
DATE OF REGISTRATION	03/01/2013
TITLE	DRIVERS CAB OF A UTILITY VEHICLE

PRIORITY

PRIORITY NUMBER	DATE	COUNTRY
001335236	04/07/2012	OHIM



DESIGN NUMBER	250738		
CLASS	24-02		
1)SANOFI-AVENTIS DEUTSCHLAND GMBH, A GERMAN COMPANY OF BRÜNINGSTRASSE 50, 65929 FRANKFURT, GERMANY			
DATE OF REGISTRATION	04/01/2013		
TITLE	INJECTION DEVICE		
PRIORITY			
PRIORITY NUMBER	DATE	COUNTRY	
002 068 791	05/07/2012	OHIM	
DESIGN NUMBER	252912		
CLASS	24-02		
1)MR. SACHIN G. LOKAPURA(INDIA). A PROPRIETORSHIP FIRM AND HAVING ITS PRINCIPAL PLACE OF BUSINESS 5099, NEAR ASHA TALKIES, OPP. OMKAR APPT, SHANIWAR PETH, MIRAJ. DIST-SANGLI MIRAJ- 416410, MAHARASHTRA, INDIA			
DATE OF REGISTRATION	05/04/2013		
TITLE	DIGITAL ORAL INHALER		
PRIORITY NA			
PRIORITY NA			
DESIGN NUMBER	253382		
CLASS	13-02		
1)SU-KAM POWER SYSTEMS LTD. OF PLOT NO. WZ-1401/2, NANGAL RAYA, NEW DELHI-110046, INDIA, AN INDIAN COMPANY			
DATE OF REGISTRATION	23/04/2013		
TITLE	INVERTER		
PRIORITY NA			
PRIORITY NA			

DESIGN NUMBER	253525	
CLASS	13-03	
1)GOLD MEDAL ELECTRICALS PVT. LTD. A COMPANY REGISTERED UNDER COMPANY ACT 1956 WHOSE ADDRESS IS, A/302, KEMP PLAZA, MIND SPACE, OFF LINK ROAD, CHINCHOLI BUNDER, MALAD (WEST), MUMBAI-400064, MAHARASHTRA, INDIA		
DATE OF REGISTRATION	30/04/2013	
TITLE	SWITCH COVER PLATE	
PRIORITY NA		
DESIGN NUMBER	253549	
CLASS	13-03	
1)GOLD MEDAL ELECTRICALS PVT. LTD. A COMPANY REGISTERED UNDER COMPANY ACT 1956 WHOSE ADDRESS IS, A/302, KEMP PLAZA, MIND SPACE, OFF LINK ROAD, CHINCHOLI BUNDER, MALAD (WEST), MUMBAI-400064, MAHARASHTRA, INDIA		
DATE OF REGISTRATION	30/04/2013	
TITLE	COVER PLATE	
PRIORITY NA		
DESIGN NUMBER	253557	
CLASS	14-99	
1)GOLD MEDAL ELECTRICALS PVT. LTD. A COMPANY REGISTERED UNDER COMPANY ACT 1956 WHOSE ADDRESS IS, A/302, KEMP PLAZA, MIND SPACE, OFF LINK ROAD, CHINCHOLI BUNDER, MALAD (WEST), MUMBAI-400064, MAHARASHTRA, INDIA		
DATE OF REGISTRATION	30/04/2013	
TITLE	DOOR BELL	
PRIORITY NA		

DESIGN NUMBER	229080		
CLASS	10-07		
1)SEIKO INSTRUMENTS INC., 8, NAKSE 1-CHOME, MIHAMA-KU, CHIBA-SHI, CHIBA, JAPAN			
DATE OF REGISTRATION	04/05/2010		
TITLE	EQUIPMENT FOR PRODUCING ELECTRICAL SIGNAL		
PRIORITY			
PRIORITY NUMBER	DATE	COUNTRY	
2009-025888	05/11/2009	JAPAN	
DESIGN NUMBER	251365		
CLASS	01-01		
1)M/S JAIN & SONS, IX/6286, GALI JAIN MANDIR, GANDHI NAGAR, DELHI-110031 (AN INDIAN PROPRIETORSHIP FIRM WHOSE PROPRIETOR IS:- SMT. RANJANA JAIN AN INDIAN NATIONAL OF THE ABOVE ADDRESS)			
DATE OF REGISTRATION	01/02/2013		
TITLE	CANDY		
PRIORITY NA			
DESIGN NUMBER	253800		
CLASS	12-11		
1)TUBE INVESTMENTS OF INDIA LIMITED, AN INDIAN COMPANY INCORPORATED UNDER THE COMPANIES ACT OF 1956, HAVING ITS PRINCIPAL PLACE OF BUSINESS AT "DARE HOUSE", 234, N. S. C. BOSE ROAD, CHENNAI - 600001, STATE OF TAMIL NADU, INDIA			
DATE OF REGISTRATION	14/05/2013		
TITLE	FRAME FOR BICYCLE		
PRIORITY NA			

DESIGN NUMBER	239684	
CLASS	10-07	
1)GRAFF DIAMONDS SA, RUE DU RHONE 29, 1204 GENEVA, SWITZERLAND		
DATE OF REGISTRATION	23/09/2011	
TITLE	DECORATIVE ELEMENT FOR A WATCH	
PRIORITY		
PRIORITY NUMBER	DATE	COUNTRY
N°DM/075798	23/03/2011	WIPO

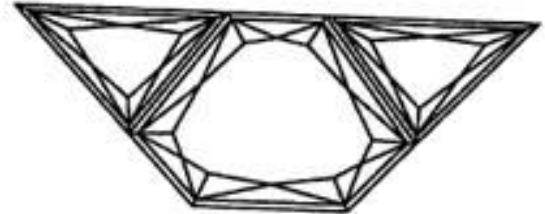

DESIGN NUMBER	249810	
CLASS	26-05	
1)SANJAY MURLIDHAR SHAH, 203 LABH SHRUSHTI BLDG., VALLABHBHAI ROAD, VILLE PARLE (WEST), MUMBAI-400056, INDIAN NATIONAL		
DATE OF REGISTRATION	30/11/2012	
TITLE	LED LIGHT	
PRIORITY NA		





DESIGN NUMBER	251496	
CLASS	12-11	
1)HONDA MOTOR CO., LTD., A CORPORATION OF JAPAN OF 1-1, MINAMI-AOYAMA 2-CHOME, MINATO-KU, TOKYO, 107-8556 JAPAN		
DATE OF REGISTRATION	07/02/2013	
TITLE	MOTOR SCOOTER	
PRIORITY		
PRIORITY NUMBER	DATE	COUNTRY
2012-019273	09/08/2012	JAPAN



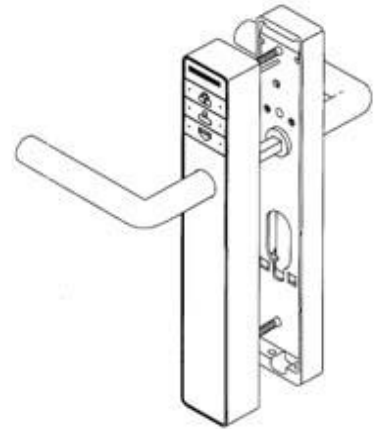

DESIGN NUMBER	253864	
CLASS	13-03	
1)AJANTA LIMITED, AN INDIAN COMPANY OF ORPAT INDUSTRIAL ESTATE, RAJKOT-MORBI HIGHWAY, MORBI 363641, STATE OF GUJARAT, INDIA		
DATE OF REGISTRATION	15/05/2013	
TITLE	SWITCH AND SOCKET	
PRIORITY NA		
DESIGN NUMBER	245156	
CLASS	08-09	
1)INVENTIO AG, A SWISS COMPANY OF POSTFACH, 6052 HERGISWIL NW, SWITZERLAND; AND INGERSOLL RAND COMPANY, A US COMPANY OF 11819 NORTH PENNSYLVANIA STREET, CARMEL IN 46032, USA		
DATE OF REGISTRATION	08/05/2012	
TITLE	DOOR LOCK SET	
PRIORITY		
PRIORITY NUMBER	DATE	COUNTRY
138423	09/11/2011	SWITZERLAND
DESIGN NUMBER	248109	
CLASS	07-02	
1)NARENDIRAN REDDY SIMMACHALAM AT 12/379, 13TH CROSS STREET, PHASE 1, SATHUVACHARI, VELLORE – 632009. INDIA		
DATE OF REGISTRATION	24/09/2012	
TITLE	COOKING PLATE	
PRIORITY NA		



DESIGN NUMBER	250737		
CLASS	24-02		
1)SANOFI-AVENTIS DEUTSCHLAND GMBH, A GERMAN COMPANY OF BRÜNINGSTRASSE 50, 65929 FRANKFURT, GERMANY			
DATE OF REGISTRATION	04/01/2013		
TITLE	INJECTION DEVICE		
PRIORITY			
PRIORITY NUMBER	DATE	COUNTRY	
002 068 791	05/07/2012	OHIM	
DESIGN NUMBER	235054		
CLASS	23-01		
1)KLAUS WAREN FIXTURES PVT. LTD., 285, PARK WIEW 1ST FLOOR, FLAT NO. 9, B.A.K. ANJAN MARG, OPP. NAPOO GARDEN, MATUNGA (CENTRAL RAILWAY) (E), MUMBAI-400019, MAHARASHTRA, INDIA			
DATE OF REGISTRATION	08/03/2011		
TITLE	ANGULAR STOP COCK		
PRIORITY NA			
DESIGN NUMBER	249157		
CLASS	19-04		
1)GUPTA, VED PRAKASH AN INDIAN AS SOLE PROPRIETOR OF VED PRAKASH SUNIL DUTT, A PROPRIETORSHIP CONCERN CARRYING ON BUSINESS AT PLOT NO. 8 DLF INDUSTRIAL AREA, MOTI NAGAR, NEW DELHI-110015			
DATE OF REGISTRATION	01/11/2012		
TITLE	STATIONARY EQUIPMENT		
PRIORITY NA			

DESIGN NUMBER	249222	
CLASS	06-07	
1)M/S TRIVENI GLASS LTD., 1, KANPUR ROAD, ALLAHABAD-211001		
DATE OF REGISTRATION	05/11/2012	
TITLE	FIGURED GLASS	
PRIORITY NA		
DESIGN NUMBER	253554	
CLASS	13-03	
1)GOLD MEDAL ELECTRICALS PVT. LTD. A COMPANY REGISTERED UNDER COMPANY ACT 1956 WHOSE ADDRESS IS, A/302, KEMP PLAZA, MIND SPACE, OFF LINK ROAD, CHINCHOLI BUNDER, MALAD (WEST), MUMBAI-400064, MAHARASHTRA, INDIA		
DATE OF REGISTRATION	30/04/2013	
TITLE	SPIKE GUARD	
PRIORITY NA		
DESIGN NUMBER	251615	
CLASS	09-03	
1)SH. SONAL JAIN (AN INDIAN NATIONAL) (PROPRIETOR) TRADING AS LITTLE PROFIT TRADING COMPANY, 2804, 2ND FLOOR, MAIN QUTAB ROAD, SADAR BAZAR, DELHI-110006		
DATE OF REGISTRATION	13/02/2013	
TITLE	PACKAGING FOR LIPSTIC	
PRIORITY NA		

DESIGN NUMBER	251666	
CLASS	06-03	
1)MA DESIGN INDIA PRIVATE LIMITED, A COMPANY INCORPORATED IN INDIA HAVING ITS PRINCIPAL PLACE OF BUSINESS AT A-41, SECTOR-80, PHASE-II, NOIDA-201305, U.P. INDIA		
DATE OF REGISTRATION	14/02/2013	
TITLE	TABLE	
PRIORITY NA		

DESIGN NUMBER	253860	
CLASS	13-03	
1)AJANTA LIMITED, AN INDIAN COMPANY OF ORPAT INDUSTRIAL ESTATE, RAJKOT-MORBI HIGHWAY, MORBI 363641, STATE OF GUJARAT, INDIA		
DATE OF REGISTRATION	15/05/2013	
TITLE	SOCKET	
PRIORITY NA		



DESIGN NUMBER	250478	
CLASS	29-99	
1)STANDARD CORPORATION INDIA LIMITED, OF STANDARD CHOWK, BARNALA, PUNJUB, INDIA, A COMPANY INCORPORATED UNDER THE COMPANIES ACT, 1956, OF THE ABOVE ADDRESS		
DATE OF REGISTRATION	26/12/2012	
TITLE	FIRE EXTINGUISHING VEHICLE	
PRIORITY NA		

DESIGN NUMBER	248117	
CLASS	07-02	
1)NARENDIRAN REDDY SIMMACHALAM AT 12/379, 13TH CROSS STREET, PHASE- 1, SATHUVACHARI, VELLORE-632009.		
DATE OF REGISTRATION	24/09/2012	
TITLE	COOKING PLATE	
PRIORITY NA		
DESIGN NUMBER	251222	
CLASS	08-06	
1)SHASHI MOHAN GARG, SANDEEP GARG, SANJEEV JAIN (DIRECTOR'S), ARE INDIAN, TRADING AS EURASIA DOOR DEVICES LIMITED (THIS COMPANY IS A PROPRIETORSHIP FIRM) WHOSE ADDRESS IS C-96, SECTOR-8, NOIDA-201301, U.P.		
DATE OF REGISTRATION	28/01/2013	
TITLE	HINGE	
PRIORITY NA		
DESIGN NUMBER	253274	
CLASS	15-04	
1)M/S ESCORTS LTD., (A COMPANY INCORPORATED UNDER INDIAN COMPANIES ACT, 1956), 15/5, MATHURA ROAD, FARIDABAD-121003, HARYANA., (INDIA)		
DATE OF REGISTRATION	22/04/2013	
TITLE	ROAD ROLLER	
PRIORITY NA		

DESIGN NUMBER	243305	
CLASS	19-04	
1) LUXOR WRITING INSTRUMENTS PRIVATE LIMITED 229, OKHLA INDUSTRIAL ESTATE - III, NEW DELHI - 110020, INDIA		
DATE OF REGISTRATION	23/02/2012	
TITLE	STATIONERY ITEM	
PRIORITY NA		

DESIGN NUMBER	251434	
CLASS	21-02	
1) ZEDEL (SOCIÉTÉ PAR ACTIONS SIMPLIFIÉE), A FRENCH COMPANY OF ZONE INDUSTRIELLE DE CROLLES, 38920 CROLLES, FRANCE (FR)		
DATE OF REGISTRATION	05/02/2013	
TITLE	ROPE CLAMP	
PRIORITY		
PRIORITY NUMBER	DATE	COUNTRY
002084475	07/08/2012	OHIM

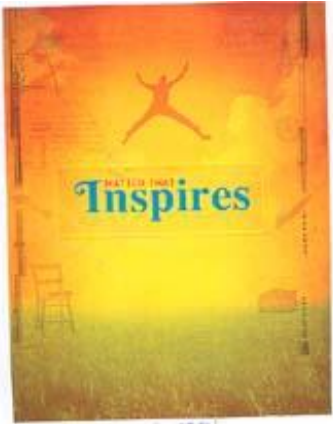
DESIGN NUMBER	253654	
CLASS	26-05	
1) ASHISH DHINGRA, AN INDIAN NATIONAL, OF THE ADDRESS 105, KOTHIWAL NAGAR, MORADABAD-244001, UTTAR PRADESH, INDIA		
DATE OF REGISTRATION	03/05/2013	
TITLE	LAMP	
PRIORITY NA		

DESIGN NUMBER	249156		
CLASS	19-04		
1)GUPTA, VED PRAKASH AN INDIAN AS SOLE PROPRIETOR OF VED PRAKASH SUNIL DUTT, A PROPRIETORSHIP CONCERN CARRYING ON BUSINESS AT PLOT NO. 8 DLF INDUSTRIAL AREA, MOTI NAGAR, NEW DELHI-110015			
DATE OF REGISTRATION	01/11/2012		
TITLE	STATIONARY EQUIPMENT		
PRIORITY NA			
DESIGN NUMBER	251835		
CLASS	31-00		
1)KONINKLIJKE PHILIPS ELECTRONICS N.V., A COMPANY ORGANIZED AND EXISTING UNDER THE LAWS OF THE KINGDOM OF THE NETHERLANDS, RESIDING AT EINDHOVEN, WHOSE POST-OFFICE ADDRESS IS HIGH TECH CAMPUS 5, 5656 AE EINDHOVEN, THE NETHERLANDS			
DATE OF REGISTRATION	22/02/2013		
TITLE	HAND BLENDER		
PRIORITY			
PRIORITY NUMBER	DATE	COUNTRY	
002093062-0002	27/08/2012	OHIM	
DESIGN NUMBER	242824		
CLASS	07-06		
1)PIK-SEL LIMITED P.O. BOX 1, PORTLAND HOUSE, STATION ROAD, BALLASALLA, ISLE OF MAN, IM99 6AB, UNITED KINGDOM			
DATE OF REGISTRATION	03/02/2012		
TITLE	CONTAINER WITH TOOTHPICKS		
PRIORITY NA			

DESIGN NUMBER	250895	
CLASS	24-01	
1)KYOWA MEDEX CO., LTD., A COMPANY ORGANIZED AND EXISTING UNDER THE LAWS OF JAPAN, OF 1-8-10, HARUMI, CHUO-KU, TOKYO 104-6004, JAPAN		
DATE OF REGISTRATION	09/01/2013	
TITLE	REACTION CONTAINER	
PRIORITY		
PRIORITY NUMBER	DATE	COUNTRY
2012-016366	10/07/2012	JAPAN



DESIGN NUMBER	251665	
CLASS	06-03	
1)MA DESIGN INDIA PRIVATE LIMITED, A COMPANY INCORPORATED IN INDIA HAVING ITS PRINCIPAL PLACE OF BUSINESS AT A-41, SECTOR-80, PHASE-II, NOIDA-201305, U.P. INDIA		
DATE OF REGISTRATION	14/02/2013	
TITLE	TABLE	
PRIORITY NA		



DESIGN NUMBER	247649	
CLASS	09-07	
1)RACHIT ATREY S/O. SH. V. K. ATREY, H NO. 181, AVAS-VIKAS COLONY, ROORKEE DIST., HARIDWAR, UTTRAKHAND, INDIA, AN INDIAN NATIONAL, OF THE ABOVE ADDRESS		
DATE OF REGISTRATION	05/09/2012	
TITLE	BOTTLE FLOW CONTROLLER	
PRIORITY NA		



DESIGN NUMBER	248116	
CLASS	07-02	
1)NARENDIRAN REDDY SIMMACHALAM AT 12/379, 13TH CROSS STREET, PHASE- 1, SATHUVACHARI, VELLORE-632009		
DATE OF REGISTRATION	24/09/2012	
TITLE	COOKING PLATE	
PRIORITY NA		
DESIGN NUMBER	253159	
CLASS	26-03	
1)PHOTOQUIP INDIA LTD., A-33, ROYAL INDUSTRIAL ESTATE, NAIGAON CROSS ROAD, WADALA, MUMBAI-400031, STATE OF MAHARASHTRA, INDIA, / A LIMITED COMPANY INCORPORATED UNDER INDIAN COMPANIES ACT., ABOVE ADDRESS		
DATE OF REGISTRATION	15/04/2013	
TITLE	SPOT LIGHT	
PRIORITY NA		
DESIGN NUMBER	253273	
CLASS	15-04	
1)M/S ESCORTS LTD., (A COMPANY INCORPORATED UNDER INDIAN COMPANIES ACT, 1956), 15/5, MATHURA ROAD, FARIDABAD-121003, HARYANA., (INDIA)		
DATE OF REGISTRATION	22/04/2013	
TITLE	ROAD ROLLER	
PRIORITY NA		

DESIGN NUMBER	250616	
CLASS	12-08	
1)MAN TRUCK & BUS AG, A GERMAN COMPANY OF DACHAUER STR. 667, 80995 MÜNICH, GERMANY		
DATE OF REGISTRATION	03/01/2013	
TITLE	DRIVERS CAB OF A UTILITY VEHICLE	
PRIORITY		
PRIORITY NUMBER	DATE	COUNTRY
001335236	04/07/2012	OHIM



DESIGN NUMBER	249158	
CLASS	19-04	
1)GUPTA, VED PRAKASH AN INDIAN AS SOLE PROPRIETOR OF VED PRAKASH SUNIL DUTT, A PROPRIETORSHIP CONCERN CARRYING ON BUSINESS AT PLOT NO. 8 DLF INDUSTRIAL AREA, MOTI NAGAR, NEW DELHI-110015		
DATE OF REGISTRATION	01/11/2012	
TITLE	STATIONARY EQUIPMENT	
PRIORITY NA		



DESIGN NUMBER	252875	
CLASS	10-01	
1)AJANTA LIMITED, AN INDIAN COMPANY OF ORPAT INDUSTRIAL ESTATE, RAJKOT-MORBI HIGHWAY, MORBI 363641, STATE OF GUJARAT, INDIA		
DATE OF REGISTRATION	03/04/2013	
TITLE	CLOCK	
PRIORITY NA		

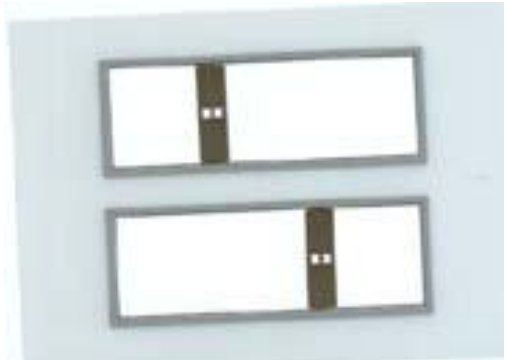

DESIGN NUMBER	249918	
CLASS	07-02	
1)SHASHIDHARA B. T., AN INDIAN NATIONAL, RESIDING AT NO. 38, SRINIVASA, 7TH CROSS, KSRTC LAYOUT, MAHADESHWARA NAGAR, HEROHALLI, BANGALORE-560091		
DATE OF REGISTRATION	05/12/2012	
TITLE	BIOMASS COOKSTOVE	
PRIORITY NA		
DESIGN NUMBER	253423	
CLASS	22-06	
1)GODREJ CONSUMER PRODUCTS LIMITED, AN INDIAN COMPANY HAVING ITS REGISTERED OFFICE AT PIROJSHANAGAR, EASTERN EXPRESS HIGHWAY, VIKHROLI, MUMBAI- 400079, STATE OF MAHARASHTRA, INDIA		
DATE OF REGISTRATION	25/04/2013	
TITLE	MOSQUITO REPELLENT MACHINE WITH BOTTLE	
PRIORITY NA		
DESIGN NUMBER	253523	
CLASS	13-03	
1)GOLD MEDAL ELECTRICALS PVT. LTD. A COMPANY REGISTERED UNDER COMPANY ACT 1956 WHOSE ADDRESS IS, A/302, KEMP PLAZA, MIND SPACE, OFF LINK ROAD, CHINCHOLI BUNDER, MALAD (WEST), MUMBAI-400064, MAHARASHTRA, INDIA		
DATE OF REGISTRATION	30/04/2013	
TITLE	SWITCH PLATE	
PRIORITY NA		

DESIGN NUMBER	253531	
CLASS	13-03	
1)GOLD MEDAL ELECTRICALS PVT. LTD. A COMPANY REGISTERED UNDER COMPANY ACT 1956 WHOSE ADDRESS IS, A/302, KEMP PLAZA, MIND SPACE, OFF LINK ROAD, CHINCHOLI BUNDER, MALAD (WEST), MUMBAI-400064, MAHARASHTRA, INDIA		
DATE OF REGISTRATION	30/04/2013	
TITLE	SWITCH COVER PLATE	
PRIORITY NA		

DESIGN NUMBER	253547	
CLASS	13-03	
1)GOLD MEDAL ELECTRICALS PVT. LTD. A COMPANY REGISTERED UNDER COMPANY ACT 1956 WHOSE ADDRESS IS, A/302, KEMP PLAZA, MIND SPACE, OFF LINK ROAD, CHINCHOLI BUNDER, MALAD (WEST), MUMBAI-400064, MAHARASHTRA, INDIA		
DATE OF REGISTRATION	30/04/2013	
TITLE	EXTENSION CORD	
PRIORITY NA		

DESIGN NUMBER	253555	
CLASS	14-99	
1)GOLD MEDAL ELECTRICALS PVT. LTD. A COMPANY REGISTERED UNDER COMPANY ACT 1956 WHOSE ADDRESS IS, A/302, KEMP PLAZA, MIND SPACE, OFF LINK ROAD, CHINCHOLI BUNDER, MALAD (WEST), MUMBAI-400064, MAHARASHTRA, INDIA		
DATE OF REGISTRATION	30/04/2013	
TITLE	DOOR BELL	
PRIORITY NA		

DESIGN NUMBER	253861	 <p>Front view</p>
CLASS	13-03	
1)AJANTA LIMITED, AN INDIAN COMPANY OF ORPAT INDUSTRIAL ESTATE, RAJKOT-MORBI HIGHWAY, MORBI 363641, STATE OF GUJARAT, INDIA		
DATE OF REGISTRATION	15/05/2013	
TITLE	TELEPHONE SOCKET	
PRIORITY NA		
DESIGN NUMBER	250527	
CLASS	13-03	
1)LARSEN & TOUBRO LIMITED, AN INDIAN COMPANY INCORPORATED UNDER THE COMPANIES ACT, 1956 OF L & T HOUSE, BALLARD ESTATE, MUMBAI 400001, STATE OF MAHARASHTRA, INDIA		
DATE OF REGISTRATION	28/12/2012	
TITLE	MOULDED CASE CIRCUIT BREAKER	
PRIORITY NA		
DESIGN NUMBER	248094	
CLASS	13-03	
1)1) MR. LALIT T. GWALANI AND 2) MRS. SUNITA R. GWALANI, PARTNERS- INDIAN NATIONAL, TRADING AS DOSSAN ENGINEERING COMPANY, A REGISTERED PARTNERSHIP FIRM IN INDIA, HAVING ITS REGISTERED OFFICE AT 205, BAJSON INDUSTRIAL ESTATE, 40, CHAKALA ROAD, ANDHERI (EAST), MUMBAI 400099, STATE OF MAHARASHTRA, INDIA, OF ABOVE ADDRESS		
DATE OF REGISTRATION	24/09/2012	
TITLE	SOCKET	
PRIORITY NA		

DESIGN NUMBER	248118	
CLASS	07-02	
1)NARENDIRAN REDDY SIMMACHALAM AT 12/379, 13TH CROSS STREET, PHASE- 1, SATHUVACHARI, VELLORE- 632009.		
DATE OF REGISTRATION	24/09/2012	
TITLE	COOKING PLATE	
PRIORITY NA		

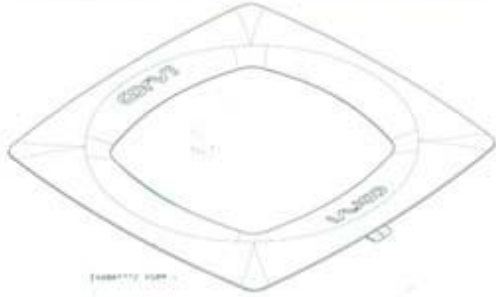
DESIGN NUMBER	253168	
CLASS	26-05	
1)PHOTOQUIP INDIA LTD., A-33, ROYAL INDUSTRIAL ESTATE, NAIGAON CROSS ROAD, WADALA, MUMBAI-400031, STATE OF MAHARASHTRA, INDIA, / A LIMITED COMPANY INCORPORATED UNDER INDIAN COMPANIES ACT., ABOVE ADDRESS		
DATE OF REGISTRATION	16/04/2013	
TITLE	FLAT LIGHT	
PRIORITY NA		

DESIGN NUMBER	250733	
CLASS	24-02	
1)SANOFI-AVENTIS DEUTSCHLAND GMBH, A GERMAN COMPANY OF BRUNINGSTRASSE 50, 65929 FRANKFURT, GERMANY		
DATE OF REGISTRATION	04/01/2013	
TITLE	INJECTION DEVICE	
PRIORITY		
PRIORITY NUMBER	DATE	COUNTRY
002 068 791	05/07/2012	OHIM

DESIGN NUMBER	250744	
CLASS	06-01	
1)GODREJ & BOYCE MFG. CO. LTD., AN INDIAN COMPANY INCORPORATED UNDER THE COMPANIES ACT 1913, OF GODREJ INTERIO, PLANT 4, PIROJSHANAGER, VIKHROLI (WEST), MUMBAI-400079, INDIA		
DATE OF REGISTRATION	04/01/2013	
TITLE	CHAIR	
PRIORITY NA		
DESIGN NUMBER	234848	
CLASS	13-01	
1)TOPLAND ENGINES PVT. LTD TOPLAND 2, UMAKANT PANDIT UDYOGNAGAR, MAVDI PLOT, RAJKOT-360004 GUJARAT (INDIA).		
DATE OF REGISTRATION	01/03/2011	
TITLE	POWER GENERATION UNIT	
PRIORITY NA		
DESIGN NUMBER	252554	
CLASS	23-01	
1)BHARAT HEAVY ELECTRICALS LIMITED, WITH ONE OF ITS REGIONAL OFFICES AT REGIONAL OPERATIONS DIVISION (ROD), PLOT NO. 9/1, DJ BLOCK, 3RD FLOOR, KARUNAMOYEE, SLAT LAKE CITY, KOLKATA-700091, HAVING ITS REGISTERED OFFICE AT BHEL HOUSE SIRI FORT, NEW DELHI-110049		
DATE OF REGISTRATION	20/03/2013	
TITLE	BUTTERFLY VALVE FOR COOLING WATER APPLICATION OF THERMAL POWER PLANTS	
PRIORITY NA		

DESIGN NUMBER	241393	
CLASS	23-04	
1)ZOBELLE HOLDING S.P.A., VIA FERSINA 4, 38100 TRENTO, ITALY		
DATE OF REGISTRATION	12/12/2011	
TITLE	DIFFUSING EVAPORATORS OF ACTIVE SUBSTANCES	
PRIORITY		
PRIORITY NUMBER	DATE	COUNTRY
001876871-0002	13/06/2011	OHIM

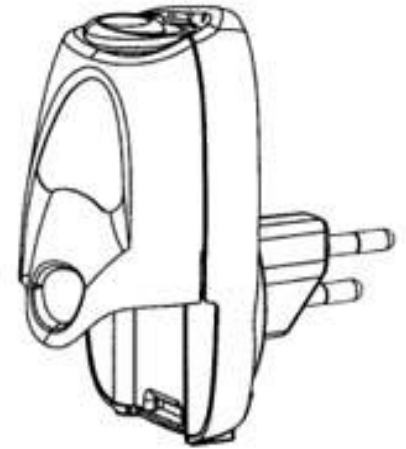

DESIGN NUMBER	253528	
CLASS	13-03	
1)GOLD MEDAL ELECTRICALS PVT. LTD. A COMPANY REGISTERED UNDER COMPANY ACT 1956 WHOSE ADDRESS IS, A/302, KEMP PLAZA, MIND SPACE, OFF LINK ROAD, CHINCHOLI BUNDER, MALAD (WEST), MUMBAI-400064, MAHARASHTRA, INDIA		
DATE OF REGISTRATION	30/04/2013	
TITLE	SWITCH COVER PLATE	
PRIORITY NA		



DESIGN NUMBER	253552	
CLASS	26-04	
1)GOLD MEDAL ELECTRICALS PVT. LTD. A COMPANY REGISTERED UNDER COMPANY ACT 1956 WHOSE ADDRESS IS, A/302, KEMP PLAZA, MIND SPACE, OFF LINK ROAD, CHINCHOLI BUNDER, MALAD (WEST), MUMBAI-400064, MAHARASHTRA, INDIA		
DATE OF REGISTRATION	30/04/2013	
TITLE	NIGHT LAMP	
PRIORITY NA		



DESIGN NUMBER	251433		
CLASS	21-02		
1)ZEDEL (SOCIÉTÉ PAR ACTIONS SIMPLIFIÉE), A FRENCH COMPANY OF ZONE INDUSTRIELLE DE CROLLES, 38920 CROLLES, FRANCE (FR)			
DATE OF REGISTRATION	05/02/2013		
TITLE	ROPE CLAMP		
PRIORITY			
PRIORITY NUMBER	DATE	COUNTRY	
002084459	07/08/2012	OHIM	
DESIGN NUMBER	252851		
CLASS	10-01		
1)AJANTA LIMITED, AN INDIAN COMPANY OF ORPAT INDUSTRIAL ESTATE, RAJKOT-MORBI HIGHWAY, MORBI 363641, STATE OF GUJARAT, INDIA			
DATE OF REGISTRATION	03/04/2013		
TITLE	CLOCK		
PRIORITY NA			
DESIGN NUMBER	229091		
CLASS	10-07		
1)SEIKO INSTRUMENTS INC., 8, NAKASE 1-CHOME, MIHAMA-KU, CHIBA-SHI, CHIBA, JAPAN			
DATE OF REGISTRATION	04/05/2010		
TITLE	EQUIPMENT FOR PRODUCING ELECTRICAL SIGNAL		
PRIORITY			
PRIORITY NUMBER	DATE	COUNTRY	
2010-007714	29/03/2010	JAPAN	

DESIGN NUMBER	246489	
CLASS	15-99	
1)TECHNOLOGICAL RESOURCES PTY. LIMITED; AN AUSTRALIAN COMPANY OF 120 COLLINS STREET, MELBOURNE, VICTORIA 3000, AUSTRALIA		
DATE OF REGISTRATION	13/07/2012	
TITLE	VESSEL FOR MICROWAVE TREATMENT OF ORE	
PRIORITY		
PRIORITY NUMBER	DATE	COUNTRY
NO. 10208/2012	17/01/2012	AUSTRALIA

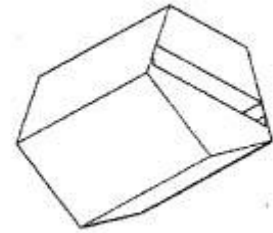



DESIGN NUMBER	251664	
CLASS	06-03	
1)MA DESIGN INDIA PRIVATE LIMITED, A COMPANY INCORPORATED IN INDIA HAVING ITS PRINCIPAL PLACE OF BUSINESS AT A-41, SECTOR-80, PHASE-II, NOIDA-201305, U.P. INDIA		
DATE OF REGISTRATION	14/02/2013	
TITLE	TABLE	
PRIORITY NA		



DESIGN NUMBER	250604	
CLASS	12-08	
1)MAN TRUCK & BUS AG, A GERMAN COMPANY OF DACHAUER STR. 667, 80995 MÜNICH, GERMANY		
DATE OF REGISTRATION	03/01/2013	
TITLE	DRIVERS CAB OF A UTILITY VEHICLE	
PRIORITY		
PRIORITY NUMBER	DATE	COUNTRY
001335236	04/07/2012	OHIM

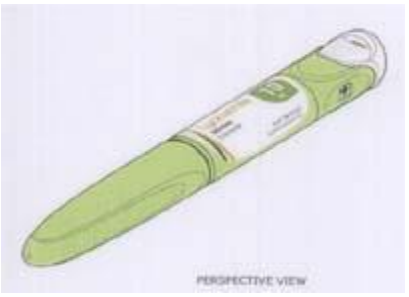

DESIGN NUMBER	250623		
CLASS	12-08		
1)MAN TRUCK & BUS AG, A GERMAN COMPANY OF DACHAUER STR. 667, 80995 MUNICH, GERMANY			
DATE OF REGISTRATION	03/01/2013		
TITLE	DRIVERS CAB OF A UTILITY VEHICLE		
PRIORITY			
PRIORITY NUMBER	DATE	COUNTRY	
001335236	04/07/2012	OHIM	
DESIGN NUMBER	250741		
CLASS	24-02		
1)SANOFI-AVENTIS DEUTSCHLAND GMBH, A GERMAN COMPANY OF BRÜNINGSTRASSE 50, 65929 FRANKFURT, GERMANY			
DATE OF REGISTRATION	04/01/2013		
TITLE	INJECTION DEVICE		
PRIORITY			
PRIORITY NUMBER	DATE	COUNTRY	
002 068 791	05/07/2012	OHIM	
DESIGN NUMBER	252969		
CLASS	09-01		
1)APSARA HERBALS., (AN INDIAN SOLE PROPRIETORSHIP CONCERN), HAVING OFFICE AT 200, ISLAMPURA, URDU ROAD, NEAR HASEEN CINEMA, BHIWANDI, DIST-THANE-421302. MAHARASHTRA, INDIA. WHOSE PROPRIETOR IS IQBAL AHMED MOHD. QASIM MOMIN. (INDIAN NATIONAL) OF ABOVE ADDRESS			
DATE OF REGISTRATION	09/04/2013		
TITLE	BOTTLE		
PRIORITY NA			

DESIGN NUMBER	251429	
CLASS	13-03	
1)YAZAKI CORPORATION, A JAPANESE CORPORATION OF 4-28, MITA 1-CHOME, MINATO-KU, TOKYO 108-0073 JAPAN		
DATE OF REGISTRATION	05/02/2013	
TITLE	FUSE	
PRIORITY		
PRIORITY NUMBER	DATE	COUNTRY
2012-019097	08/08/2012	JAPAN

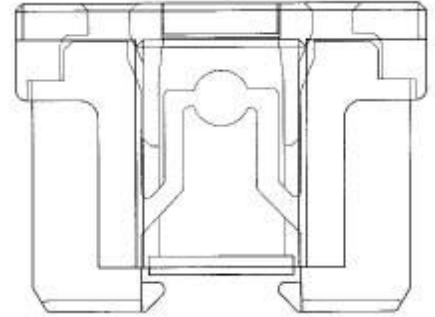



DESIGN NUMBER	252802	
CLASS	07-05	
1)M/S V. K. PRODUCTS, S.C.O.-21-B, GURBACHAN MARKET, LINK ROAD, NEAR DHOLEWAL BRIDGE, LUDHIANA-141003, PUNJAB, INDIA. AN INDIAN PROPRIETORSHIP FIRM WHOSE PROPRIETOR IS: SH. SACHIN KUMAR		
DATE OF REGISTRATION	03/04/2013	
TITLE	WIPER FOR FLOOR CLEANING	
PRIORITY NA		



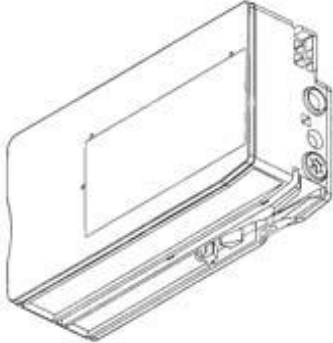

DESIGN NUMBER	253435	
CLASS	12-11	
1)RAJU RUBBER INDUSTRIES OF INDUSTRIAL AREA 'C', JASPAL BANGAR ROAD, OPPOSITE SATYAM DHARAM KANDA, SUA ROAD, LUDHIANA-141010 (PUNJAB), INDIA, AN INDIAN PROPRIETORSHIP FIRM WHOSE PROPRIETRESS IS SMT. DARSHNA BANSAL		
DATE OF REGISTRATION	26/04/2013	
TITLE	RIM FOR BICYCLES	
PRIORITY NA		





DESIGN NUMBER	253527		
CLASS	13-03		
1)GOLD MEDAL ELECTRICALS PVT. LTD. A COMPANY REGISTERED UNDER COMPANY ACT 1956 WHOSE ADDRESS IS, A/302, KEMP PLAZA, MIND SPACE, OFF LINK ROAD, CHINCHOLI BUNDER, MALAD (WEST), MUMBAI-400064, MAHARASHTRA, INDIA			
DATE OF REGISTRATION	30/04/2013		
TITLE	SWITCH COVER PLATE		
PRIORITY NA			
DESIGN NUMBER	239863		
CLASS	19-02		
1)HEWLETT-PACKARD DEVELOPMENT COMPANY, L.P., 11445 COMPAQ CENTER DRIVE WEST, HOUSTON, TX 77070, UNITED STATES OF AMERICA			
DATE OF REGISTRATION	30/09/2011		
TITLE	INK CARTRIDGE FOR PRINTER		
PRIORITY			
PRIORITY NUMBER	DATE	COUNTRY	
29/402, 495	23/09/2011	U.S.A.	
DESIGN NUMBER	251517		
CLASS	12-11		
1)BAJAJ AUTO LIMITED, AN INDIAN COMPANY, INCORPORATED UNDER THE COMPANIES ACT OF 1956, HAVING ITS PRINCIPAL PLACE OF BUSINESS AT NEW 2ND & 3RD FLOOR, KHIVRAJ BUILDING, NO. 616, ANNASALAI, CHENNAI - 600006, STATE OF TAMIL NADU, INDIA, AND REGISTERED OFFICE AT AKURDI, PUNE-411035, STATE OF MAHARASHTRA, INDIA			
DATE OF REGISTRATION	08/02/2013		
TITLE	MIRROR ASSEMBLY FOR MOTORCYCLE		
PRIORITY NA			

DESIGN NUMBER	250555	
CLASS	08-07	
1)MAHINDRA 2 WHEELERS LIMITED, A COMPANY INCORPORATED UNDER THE INDIAN COMPANIES ACT, AT D1 BLOCK, PLOT NO. 18/2 (PART), MIDC, CHINCHWAD, PUNE-411019, MAHARASHTRA, INDIA		
DATE OF REGISTRATION	31/12/2012	
TITLE	KEY	
PRIORITY NA		
DESIGN NUMBER	248114	
CLASS	07-02	
1)NARENDIRAN REDDY SIMMACHALAM AT 12/379. 13TH CROSS STREET. PHASE- 1, SATHUVACHARI, VELLORE - 632009.		
DATE OF REGISTRATION	24/09/2012	
TITLE	COOKING PLATE	
PRIORITY NA		
DESIGN NUMBER	251106	
CLASS	21-02	
1)M/S., T. V. SHOPEE (SOLE PROPRIETARY FIRM), 8/8, NEW PALASIA, NEAR LAXMI MEMORIAL HOSPITAL, INDORE (M.P.) PIN-452001, INDIA		
DATE OF REGISTRATION	22/01/2013	
TITLE	GYMNASTICS APPARATUS AND EQUIPMENT	
PRIORITY NA		

DESIGN NUMBER	250603		
CLASS	12-08		
1)MAN TRUCK & BUS AG, A GERMAN COMPANY OF DACHAUER STR. 667, 80995 MÜNICH, GERMANY			
DATE OF REGISTRATION	03/01/2013		
TITLE	DRIVERS CAB OF A UTILITY VEHICLE		
PRIORITY			
PRIORITY NUMBER	DATE	COUNTRY	
001335236	04/07/2012	OHIM	
<hr/>			
DESIGN NUMBER	250614		
CLASS	12-08		
1)MAN TRUCK & BUS AG, A GERMAN COMPANY OF DACHAUER STR. 667, 80995 MÜNICH, GERMANY			
DATE OF REGISTRATION	03/01/2013		
TITLE	DRIVERS CAB OF A UTILITY VEHICLE		
PRIORITY			
PRIORITY NUMBER	DATE	COUNTRY	
001335236	04/07/2012	OHIM	
<hr/>			
DESIGN NUMBER	250622		
CLASS	12-08		
1)MAN TRUCK & BUS AG, A GERMAN COMPANY OF DACHAUER STR. 667, 80995 MUNICH, GERMANY			
DATE OF REGISTRATION	03/01/2013		
TITLE	DRIVERS CAB OF A UTILITY VEHICLE		
PRIORITY			
PRIORITY NUMBER	DATE	COUNTRY	
001335236	04/07/2012	OHIM	

DESIGN NUMBER	252965	
CLASS	01-01	
1)VADILAL INTERNATIONAL PVT LTD, A COMPANY INCORPORATED UNDER THE INDIAN COMPANY'S ACT, VADILAL HOUSE, SHRIMALI SOCIETY, NR. NAVRANGPURA RAILWAY CROSSING, NAVRANGPURA, AHMEDABAD 380009, GUJARAT, INDIA		
DATE OF REGISTRATION	09/04/2013	
TITLE	ICE CREAM	
PRIORITY NA		
		
DESIGN NUMBER	249604	
CLASS	21-02	
1)SCHAUENBURG RUHRKUNSTSTOFF GMBH, OF WESELER STRASSE 35, D-45478 MÜLHEIM AN DER RUHR, ALEMANIA		
DATE OF REGISTRATION	20/11/2012	
TITLE	EXERCISER FOR ATHLETES, RECREATIONAL USERS AND PATIENTS	
PRIORITY		
PRIORITY NUMBER	DATE	COUNTRY
002130344-0001	05/11/2012	OHIM
		
DESIGN NUMBER	253607	
CLASS	09-01	
1)WHIRLPOOL OF INDIA LIMITED, AN INDIAN COMPANY HAVING ITS CORPORATE OFFICE AT 'WHIRLPOOL HOUSE', PLOT NO. 40, SECTOR-44, GURGAON-122002, HARYANA, INDIA		
DATE OF REGISTRATION	01/05/2013	
TITLE	BOTTLE	
PRIORITY NA		
		

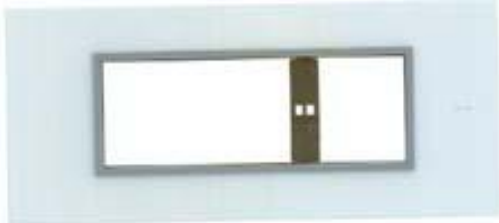
DESIGN NUMBER	253799	
CLASS	12-11	
1)TUBE INVESTMENTS OF INDIA LIMITED, AN INDIAN COMPANY INCORPORATED UNDER THE COMPANIES ACT OF 1956, HAVING ITS PRINCIPAL PLACE OF BUSINESS AT "DARE HOUSE , 234, N. S. C. BOSE ROAD, CHENNAI - 600001, STATE OF TAMIL NADU, INDIA		
DATE OF REGISTRATION	14/05/2013	
TITLE	FRAME FOR BICYCLE	
PRIORITY NA		
DESIGN NUMBER	238058	
CLASS	15-09	
1)TOPLAND ENGINES PVT. LTD 2, UMAKANT PANDIT, UDYOGNAGAR, MAVDI PLOT, RAJKOT-360004 (GUJARAT), INDIA		
DATE OF REGISTRATION	15/07/2011	
TITLE	WINDING MACHINE	
PRIORITY NA		
DESIGN NUMBER	253424	
CLASS	22-06	
1)GODREJ CONSUMER PRODUCTS LIMITED, AN INDIAN COMPANY HAVING ITS REGISTERED OFFICE AT PIROJSHANAGAR, EASTERN EXPRESS HIGHWAY, VIKHROLI, MUMBAI-400079, STATE OF MAHARASHTRA, INDIA		
DATE OF REGISTRATION	25/04/2013	
TITLE	MOSQUITO REPELLENT MACHINE	
PRIORITY NA		

DESIGN NUMBER	253524	
CLASS	13-03	
1)GOLD MEDAL ELECTRICALS PVT. LTD. A COMPANY REGISTERED UNDER COMPANY ACT 1956 WHOSE ADDRESS IS, A/302, KEMP PLAZA, MIND SPACE, OFF LINK ROAD, CHINCHOLI BUNDER, MALAD (WEST), MUMBAI-400064, MAHARASHTRA, INDIA		
DATE OF REGISTRATION	30/04/2013	
TITLE	SWITCH COVER PLATE	
PRIORITY NA		
DESIGN NUMBER	253532	
CLASS	13-03	
1)GOLD MEDAL ELECTRICALS PVT. LTD. A COMPANY REGISTERED UNDER COMPANY ACT 1956 WHOSE ADDRESS IS, A/302, KEMP PLAZA, MIND SPACE, OFF LINK ROAD, CHINCHOLI BUNDER, MALAD (WEST), MUMBAI-400064, MAHARASHTRA, INDIA		
DATE OF REGISTRATION	30/04/2013	
TITLE	SWITCH COVER PLATE	
PRIORITY NA		
DESIGN NUMBER	253548	
CLASS	13-03	
1)GOLD MEDAL ELECTRICALS PVT. LTD. A COMPANY REGISTERED UNDER COMPANY ACT 1956 WHOSE ADDRESS IS, A/302, KEMP PLAZA, MIND SPACE, OFF LINK ROAD, CHINCHOLI BUNDER, MALAD (WEST), MUMBAI-400064, MAHARASHTRA, INDIA		
DATE OF REGISTRATION	30/04/2013	
TITLE	EXTENSION CORD	
PRIORITY NA		

DESIGN NUMBER	253556		 <p>Gold Medal Electricals Pvt. Ltd.</p> <p>FRONT VIEW</p>
CLASS	14-99		
1)GOLD MEDAL ELECTRICALS PVT. LTD. A COMPANY REGISTERED UNDER COMPANY ACT 1956 WHOSE ADDRESS IS, A/302, KEMP PLAZA, MIND SPACE, OFF LINK ROAD, CHINCHOLI BUNDER, MALAD (WEST), MUMBAI-400064, MAHARASHTRA, INDIA			
DATE OF REGISTRATION	30/04/2013		
TITLE	DOOR BELL		
PRIORITY NA			
DESIGN NUMBER	249809		
CLASS	26-05		
1)SANJAY MURLIDHAR SHAH, 203 LABH SHRUSHTI BLDG., VALLABHBHAI ROAD, VILLE PARLE (WEST), MUMBAI-400056, INDIAN NATIONAL			
DATE OF REGISTRATION	30/11/2012		
TITLE	LED LIGHT		
PRIORITY NA			
DESIGN NUMBER	251552		
CLASS	10-04		
1)IMADA CO., LTD., 99, JINNOSHINDEN-CHO, AZA KANOWARI, TOYOHASHI-SHI, AICHI-KEN, 441-8077, JAPAN, A JAPANESE COMPANY			
DATE OF REGISTRATION	08/02/2013		
TITLE	FORCE GAUGE		
PRIORITY			
PRIORITY NUMBER	DATE	COUNTRY	
2012-028328	20/11/2012	JAPAN	

DESIGN NUMBER	252236	
CLASS	09-01	
1)MR. SACHIN SACHDEV MRS. MANASI SACHDEV AND MR. RAVI CHAWLA ALL PARTNERS OF NAYASA MULTIPLAST BEING A PARTNERSHIP CONCERN DULY REGISTERED UNDER THE PARTNERSHIP ACT, 1932 HAVING ITS ADDRESS AT PLOT NOS. 224, 225, 227 AND 228, VILLAGE BELA BATHRI, TAHASIL HAROLI, DISTRICT UNA-732141, HIMACHAL PRADESH		
DATE OF REGISTRATION	08/03/2013	
TITLE	BOTTLE	
PRIORITY NA		

DESIGN NUMBER	252429	
CLASS	19-06	
1)FLAIR PENS LIMITED, AN INDIAN PARTNERSHIP FIRM OF 63, B/C, GOVT. INDUSTRIAL ESTATE, CHARKOP, KANDIVALI (W), MUMBAI - 400067, MAHARASHTRA, INDIA		
DATE OF REGISTRATION	19/03/2013	
TITLE	MARKER PEN	
PRIORITY NA		

DESIGN NUMBER	238323	
CLASS	06-08	
1)KALPESH MANSUKHBAHI DUDHATRA C/O. JAY BALAJI INDUSTRIES, SHIVAM INDUSTRIES AREA, BEHIND PETROL PUMP, KOTHARIYA RING ROAD, RAJKOT-360002 GUJARAT (INDIA)		
DATE OF REGISTRATION	26/07/2011	
TITLE	WALL HANGER	
PRIORITY NA		

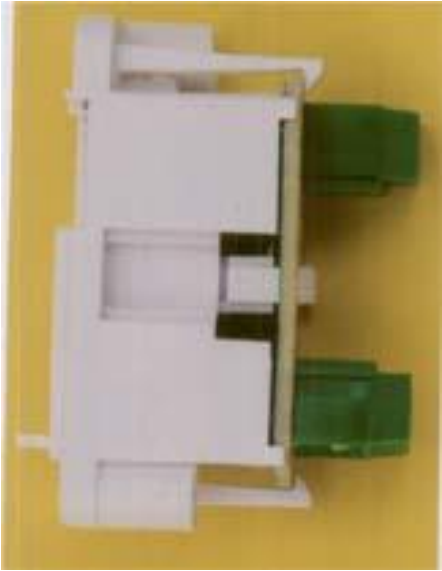
DESIGN NUMBER	248095	
CLASS	13-03	
1)1) MR. LALIT T. GWALANI AND 2) MRS. SUNITA R. GWALANI, PARTNERS-INDIAN NATIONAL, TRADING AS DOSSAN ENGINEERING COMPANY, A REGISTERED PARTNERSHIP FIRM IN INDIA, HAVING ITS REGISTERED OFFICE AT 205, BAJSON INDUSTRIAL ESTATE, 40, CHAKALA ROAD, ANDHERI (EAST), MUMBAI 400099, STATE OF MAHARASHTRA, INDIA, OF ABOVE ADDRESS		
DATE OF REGISTRATION	24/09/2012	
TITLE	SOCKET	
PRIORITY NA		

DESIGN NUMBER	253169	
CLASS	26-05	
1)PHOTOQUIP INDIA LTD., A-33, ROYAL INDUSTRIAL ESTATE, NAIGAON CROSS ROAD, WADALA, MUMBAI-400031, STATE OF MAHARASHTRA, INDIA, / A LIMITED COMPANY INCORPORATED UNDER INDIAN COMPANIES ACT., ABOVE ADDRESS		
DATE OF REGISTRATION	16/04/2013	
TITLE	FLAT LIGHT	
PRIORITY NA		

DESIGN NUMBER	253380	
CLASS	13-02	
1)SU-KAM POWER SYSTEMS LTD. OF PLOT NO. WZ-1401/2, NANGAL RAYA, NEW DELHI-110046, INDIA, AN INDIAN COMPANY		
DATE OF REGISTRATION	23/04/2013	
TITLE	INVERTER	
PRIORITY NA		

DESIGN NUMBER	250611	
CLASS	12-08	
1)MAN TRUCK & BUS AG, A GERMAN COMPANY OF DACHAUER STR. 667, 80995 MÜNICH, GERMANY		
DATE OF REGISTRATION	03/01/2013	
TITLE	DRIVERS CAB OF A UTILITY VEHICLE	
PRIORITY		
PRIORITY NUMBER	DATE	COUNTRY
001335236	04/07/2012	OHIM

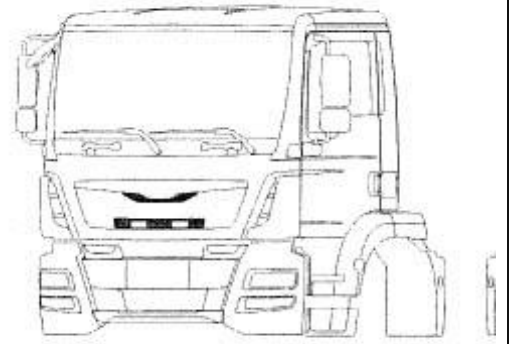

DESIGN NUMBER	250734	
CLASS	24-02	
1)SANOFI-AVENTIS DEUTSCHLAND GMBH, A GERMAN COMPANY OF BRÜNINGSTRASSE 50, 65929 FRANKFURT, GERMANY		
DATE OF REGISTRATION	04/01/2013	
TITLE	INJECTION DEVICE	
PRIORITY		
PRIORITY NUMBER	DATE	COUNTRY
002 068 791	05/07/2012	OHIM



DESIGN NUMBER	250745	
CLASS	06-01	
1)GODREJ & BOYCE MFG. CO. LTD., AN INDIAN COMPANY INCORPORATED UNDER THE COMPANIES ACT 1913, OF GODREJ INTERIO, PLANT 4, PIROJSHANAGER, VIKHROLI (WEST), MUMBAI-400079, INDIA		
DATE OF REGISTRATION	04/01/2013	
TITLE	CHAIR	
PRIORITY NA		

