

***CONTINUED FROM PART- 1***

**INTRODUCTION**

In view of the recent amendment made in the Designs (Amendment) Rules, 2008 with effect from 17/06/2008, Publication of the matter relating to Designs is being published in the Official Journal of The Patent Office. This Journal is being published on weekly basis on every Friday covering the various proceedings on Designs as required according to the provisions of under Rule 22, 25, 27 and 39 of the Design (Amendment) Rules, 2008. All the enquiries on this Official Journal and other information as required by the public should be addressed to the Controller General of Patents, Designs & Trade Marks. Suggestions and comments are requested from all quarters so that the content can be enriched.

## COPYRIGHT PUBLICATION

<b>SL NO</b>	<b>CASE NUMBERS</b>	<b>RENEWED ON</b>
1.	188092	21.10.2013
2.	196244	21.10.2013
3.	197126	21.10.2013
4.	197127	21.10.2013
5.	197128	21.10.2013
6.	197735	21.10.2013
7.	245255	21.10.2013
8.	248100	21.10.2013
9.	248101	21.10.2013
10.	248102	21.10.2013
11.	248103	21.10.2013
12.	248104	21.10.2013
13.	248106	21.10.2013
14.	248107	21.10.2013
15.	248108	21.10.2013
16.	194074	25.10.2013
17.	192925	25.10.2013
18.	192182	25.10.2013
19.	190618	28.10.2013
20.	194094	25.10.2013
21.	193836	25.10.2013
22.	196221	25.10.2013
23.	194326	25.10.2013
24.	194073	25.10.2013
25.	249329	31.10.2013
26.	249334	31.10.2013
27.	211311	31.10.2013
28.	211312	31.10.2013
29.	249481	01.09.2013

**THE DESIGNS ACT 2000**  
**SECTION 30**  
**DESIGN ASSIGNMENT**

The Design stands in the name of **De La Rue International Ltd** registered under the Designs Act, 2000 has been assigned in the Register of Designs in the name as follows:-

<b>Design No.</b>	<b>Class</b>	<b>Name</b>
212770, 212771, 212774, 212773, 212772, 212769, 212767, 212768, 207728, 207729, 212707, 212708	19-02	<b>TALARIS HOLDINGS LIMITED, A BRITISH COMPANY, OF 10 UPPER BANK STREET, LONDON E14 5JJ, UNITED KINGDOM</b>

**RESTORATION OF LAPSED DESIGNS  
UNDER SECTION 12 (2) OF THE DESIGNS ACT, 2000**

An application made under Section 12 (2) of the Designs act, 2000 on **04.06.2012**, for Restoration of **Design No.188092 dated 11.02.2002** in the name of **LARSEN & TOUBRO LIMITED, AN INDIAN COMPANY, OF L & T HOUSE, BALLARD ESTATE, MUMBAI-400001, MAHARASHTRA, INDIA** has been allowed.

## REGISTRATION OF DESIGNS

The following designs have been registered. They are now open for public inspection. In the following each entry the Date of Registration is shown. The Priority Number, Priority Date and Priority Country are also shown

<b>DESIGN NUMBER</b>	249951	
<b>CLASS</b>	08-08	
<b>1)TESEO S.R.L., OF</b> VIA DEGLI OLEANDRI, 1, I-25015 DESENZANO DEL GARDA (BS)- ITALY, AN ITALIAN LIMITED LIABILITY COMPANY		
<b>DATE OF REGISTRATION</b>	05/12/2012	
<b>TITLE</b>	BRACKET FOR SUPPORTING AIR SUPPLY LINES	
<b>PRIORITY</b>		
PRIORITY NUMBER	DATE	
2052506-001	05/06/2012	OHIM
<b>DESIGN NUMBER</b>	248196	
<b>CLASS</b>	18-02	
<b>1)ELECTRONICS FOR IMAGING INC. OF THE ADDRESS:</b> 303 VELOCITY WAY, FOSTER CITY, CA 94404, UNITED STATES OF AMERICA		
<b>DATE OF REGISTRATION</b>	27/09/2012	
<b>TITLE</b>	PRINTER	
<b>PRIORITY NA</b>		
<b>DESIGN NUMBER</b>	248300	
<b>CLASS</b>	09-01	
<b>1)M/S. AISHWARYA ELECTRICALS (P) LTD. (A COMPANY INCORPORATED</b> <b>UNDER THE INDIAN COMPANIES ACT, 1956),</b> F 1/C, SITE NO. 1, PANKI INDUSTRIAL AREA, KANPUR U.P.		
<b>DATE OF REGISTRATION</b>	01/10/2012	
<b>TITLE</b>	BOTTLE PREFORM	
<b>PRIORITY NA</b>		

<b>DESIGN NUMBER</b>	251550	
<b>CLASS</b>	09-07	
1)APTARGROUP, INC., 475 WEST TERRA COTTA, SUITE E, CRYSTAL LAKE, ILLINOIS 60014-9695, UNITED STATES OF AMERICA, A DELAWARE CORPORATION		
<b>DATE OF REGISTRATION</b>	08/02/2013	
<b>TITLE</b>	CLOSURE	
<b>PRIORITY</b>		
<b>PRIORITY NUMBER</b>	<b>DATE</b>	<b>COUNTRY</b>
29/431,095	04/09/2012	U.S.A.

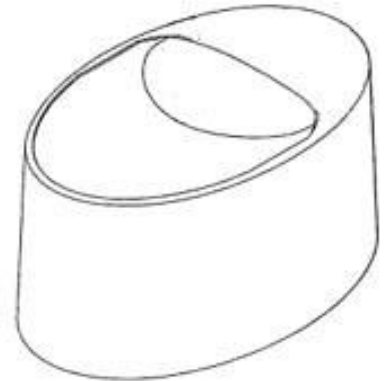

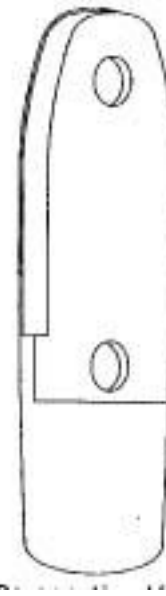

<b>DESIGN NUMBER</b>	225085	
<b>CLASS</b>	25-02	
1)LISUS TECHNOLOGY PTE LTD., BLOCK 1090, LOWER DELTA RD#04-01/02, SINGAPORE 169201		
<b>DATE OF REGISTRATION</b>	05/10/2009	
<b>TITLE</b>	SUPPORT BRACKET FOR GLASS FENCING	
<b>PRIORITY NA</b>		



<b>DESIGN NUMBER</b>	250522	
<b>CLASS</b>	15-05	
1)WHIRLPOOL OF INDIA LIMITED, AN INDIAN COMPANY HAVING ITS CORPORATE OFFICE AT 'WHIRLPOOL HOUSE', PLOT NO. 40, SECTOR-44, GURGAON-122002, HARYANA, INDIA		
<b>DATE OF REGISTRATION</b>	28/12/2012	
<b>TITLE</b>	WASHING MACHINE	
<b>PRIORITY NA</b>		





<b>DESIGN NUMBER</b>	251385	
<b>CLASS</b>	10-05	
<b>1)M/S. GA INSTRUMENT (P) LIMITED, REPRESENTED BY ITS DIRECTOR MR. D. RAJESH KUMAR, INDIAN NATIONAL, CARRYING ON BUSINESS AT NO. 47, NARAYANA MUDALI STREET, SOWCARPET, CHENNAI-600079, INDIA</b>		
<b>DATE OF REGISTRATION</b>	04/02/2013	
<b>TITLE</b>	WATER TESTER INSTRUMENT	
<b>PRIORITY NA</b>		

<b>DESIGN NUMBER</b>	243889	
<b>CLASS</b>	02-04	
<b>1)GUPTA H. C. OVERSEAS (I) PVT. LTD. NEAR TUBE WELL COMPANY, BYE PASS ROAD, AGRA (U.P.), INDIA</b>		
<b>DATE OF REGISTRATION</b>	15/03/2012	
<b>TITLE</b>	ZIP SHOES WITH SLIPPERS	
<b>PRIORITY NA</b>		

<b>DESIGN NUMBER</b>	252825	
<b>CLASS</b>	09-01	
<b>1)RECKITT BENCKISER N. V., A DUTCH COMPANY OF SIRIUSDREEF 14, 2132 WT HOOFFDORP, NETHERLANDS</b>		
<b>DATE OF REGISTRATION</b>	03/04/2013	
<b>TITLE</b>	BOTTLE WITH CAP	
<b>PRIORITY</b>		
<b>PRIORITY NUMBER</b>	<b>DATE</b>	<b>COUNTRY</b>
002115113	08/10/2012	OHIM

<b>DESIGN NUMBER</b>	249050	
<b>CLASS</b>	08-06	
<b>1)RAJESHBHAI SAMBHUBHAI KOTADIYA (INDIAN NATIONALS) SOLE PROPRIETOR OF PIONEER METAL (INDIAN PROPRIETORSHIP CONCERN) HAVING PLACE OF BUSINESS</b> AT-1/8, RAMNAGAR, 80, FEET ROAD, B/H. K. RASHIKLAL, RAJKOT-360003 GUJARAT (INDIA)		
<b>DATE OF REGISTRATION</b>	29/10/2012	
<b>TITLE</b>	HANDLE	
<b>PRIORITY NA</b>		
<b>DESIGN NUMBER</b>	254699	
<b>CLASS</b>	06-13	
<b>1)SCI EXPORT (P) LTD., SITUATED AT WZ-NA-240, VISHNU GARDEN, NEW DELHI-110018 (INDIA)</b> A COMPANY INCORPORATED UNDER THE INDIAN COMPANIES ACT, OF ABOVE ADDRESS		
<b>DATE OF REGISTRATION</b>	24/06/2013	
<b>TITLE</b>	SOFA BACK COVER	
<b>PRIORITY NA</b>		
<b>DESIGN NUMBER</b>	254708	
<b>CLASS</b>	06-13	
<b>1)SCI EXPORT (P) LTD., SITUATED AT WZ-NA-240, VISHNU GARDEN, NEW DELHI-110018 (INDIA)</b> A COMPANY INCORPORATED UNDER THE INDIAN COMPANIES ACT, OF ABOVE ADDRESS		
<b>DATE OF REGISTRATION</b>	24/06/2013	
<b>TITLE</b>	SOFA BACK COVER	
<b>PRIORITY NA</b>		



<b>DESIGN NUMBER</b>	248457	
<b>CLASS</b>	08-06	
<b>1)SANVI ENTERPRISE, NATIONAL HIGH WAY</b> 8-B, OPP. PARIN FURNITURE, KOTHARIYA SOLVENT AREA, NEAR DHOKIYA MOTORS, KOTHARIYA, DIST: RAJKOT-360004, GUJARAT, INDIA, INDIAN COMPANY		
<b>DATE OF REGISTRATION</b>	04/10/2012	
<b>TITLE</b>	HANDLE	
<b>PRIORITY NA</b>		
<b>DESIGN NUMBER</b>	250978	
<b>CLASS</b>	12-11	
<b>1)BAJAJ AUTO LIMITED,</b> AKURDI, PUNE-411035, STATE OF MAHARASHTRA, INDIA.		
<b>DATE OF REGISTRATION</b>	14/01/2013	
<b>TITLE</b>	MOTORCYCLE	
<b>PRIORITY NA</b>		
<b>DESIGN NUMBER</b>	251984	
<b>CLASS</b>	19-06	
<b>1)ADD CORPORATION LIMITED OF</b> BUSINESS PARK, 6TH FLOOR, CHINCHOLI NAKA, S.V. ROAD, MALAD (WEST), MUMBAI-400064, MAHARASHTRA, INDIA, INDIAN COMPANY		
<b>DATE OF REGISTRATION</b>	01/03/2013	
<b>TITLE</b>	WRITING INSTRUMENT	
<b>PRIORITY NA</b>		

<b>DESIGN NUMBER</b>	249615	
<b>CLASS</b>	13-03	
<b>1)PHOENIX CONTACT GMBH &amp; CO. KG; A GERMAN COMPANY OF</b> BRUNO MUTH; FLACHSMARKTSTR. 8, D-32825 BLOMBERG, GERMANY		
<b>DATE OF REGISTRATION</b>	21/11/2012	
<b>TITLE</b>	ELECTRICAL CONNECTOR	
<b>PRIORITY</b>		
<b>PRIORITY NUMBER</b>	<b>DATE</b>	<b>COUNTRY</b>
002056028-0003	12/06/2012	OHIM

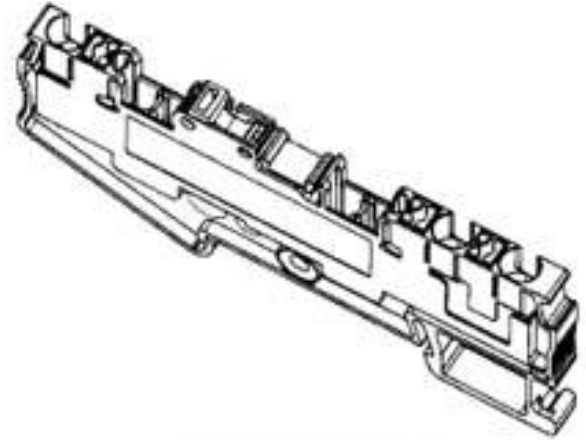

<b>DESIGN NUMBER</b>	251846	
<b>CLASS</b>	12-16	
<b>1)DR. ING. H.C.F. PORSCHE AKTIENGESELLSCHAFT, A GERMAN COMPANY OF</b> PORSCHEPLATZ 1, 70435 STUTTGART, GERMANY		
<b>DATE OF REGISTRATION</b>	25/02/2013	
<b>TITLE</b>	WHEEL RIM	
<b>PRIORITY NA</b>		



<b>DESIGN NUMBER</b>	254357	
<b>CLASS</b>	13-03	
<b>1)LECTRIX MOTORS LIMITED, 137-C, DDA, MIG FLATS, RAJOURI GARDEN EXTENSION, NEW DELHI, INDIA</b> (AN INDIAN COMPANY DULY REGISTERED UNDER THE COMPANIES ACT, 1956)		
<b>DATE OF REGISTRATION</b>	06/06/2013	
<b>TITLE</b>	STABILIZER	
<b>PRIORITY NA</b>		



<b>DESIGN NUMBER</b>	254426
<b>CLASS</b>	07-03
<b>1)MR. PARIN R. PATEL, MR. RASHIKBHAI B. PATEL AND MRS. BHAVANA R. PATEL ADULTS, INDIAN TRADING AS A PARTNER OF M/S PATEL INDUSTRIES, PARTNERSHIP FIRM REGISTERED UNDER THE INDIAN PARTNERSHIP ACT, 1932, WHOSE ADDRESS IS</b> B-106/107/108, SHRIRAM INDUSTRIAL ESTATE, BEHIND BILESHWAR ESTATE, S. P RING ROAD, ODHAV, AHMEDABAD-382415 (GUJARAT)	
<b>DATE OF REGISTRATION</b>	11/06/2013
<b>TITLE</b>	SPOON
<b>PRIORITY NA</b>	



<b>DESIGN NUMBER</b>	254471
<b>CLASS</b>	25-02
<b>1)MYSONIC INDUSTRIES, AN INDIAN PROPRIETARY CONCERN, HAVING THE OFFICE AT 530, IV PHASE, PEENYA INDUSTRIAL AREA, BANGALORE 580058 KARNATAKA, INDIA, AND HAVING THE SOLE PROPRIETOR THEREOF AS DHARAMCHAND JAWARI LAL, RESIDING</b> AT #11, 1ST MAIN ROAD, MAHAGANAPATHINAGAR, W.O.C. ROAD, RAJAJINAGAR, BANGALORE-560010 KARNATAKA, INDIA, AN INDIAN NATIONAL	
<b>DATE OF REGISTRATION</b>	13/06/2013
<b>TITLE</b>	CHANNEL
<b>PRIORITY NA</b>	



<b>DESIGN NUMBER</b>	248308
<b>CLASS</b>	15-03
<b>1)DELAVAL HOLDING AB;</b> OF GUSTAF DE LAVALS VÄG 15, SE-147, TUMBA, SWEDEN	
<b>DATE OF REGISTRATION</b>	01/10/2012
<b>TITLE</b>	TEATCUP FOR MILKING MACHINE
<b>PRIORITY NA</b>	

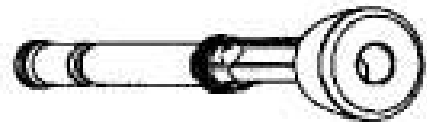

<b>DESIGN NUMBER</b>	254207	
<b>CLASS</b>	14-99	
<b>1)SAMSUNG ELECTRONICS CO., LTD.</b> 129, SAMSUNG-RO, YEONGTONG-GU, SUWON-SI, GYEONGGI-DO, 443-742, REPUBLIC OF KOREA, A COMPANY OF REPUBLIC OF KOREA		
<b>DATE OF REGISTRATION</b>	30/05/2013	
<b>TITLE</b>	CASE FOR ELECTRONIC DEVICE	
<b>PRIORITY</b>		
<b>PRIORITY NUMBER</b>	<b>DATE</b>	<b>COUNTRY</b>
30-2013-0012861	13/03/2013	REPUBLIC OF KOREA

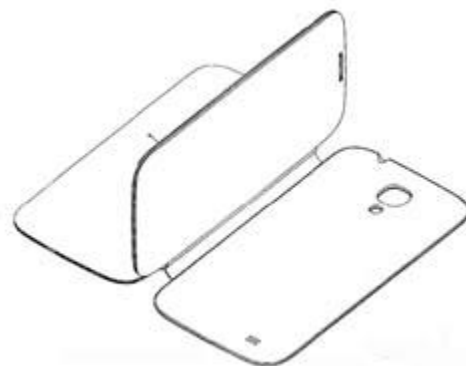

<b>DESIGN NUMBER</b>	238059	
<b>CLASS</b>	15-99	
<b>1)TOPLAND ENNGINES PVT LTD</b> 2 UMAKANT PANDIT UDYONAGAR MAVDI PLOT RAJKOT 36004 (GUJRAT) INDIA		
<b>DATE OF REGISTRATION</b>	15/07/2011	
<b>TITLE</b>	ELECTRIC DYNAMOMETER	
<b>PRIORITY NA</b>		



<b>DESIGN NUMBER</b>	252826	
<b>CLASS</b>	09-01	
<b>1)RECKITT BENCKISER N. V., A DUTCH COMPANY OF</b> SIRIUSDREEF 14, 2132 WT HOOFFDORP, NETHERLANDS		
<b>DATE OF REGISTRATION</b>	03/04/2013	
<b>TITLE</b>	BOTTLE WITH CAP	
<b>PRIORITY</b>		
<b>PRIORITY NUMBER</b>	<b>DATE</b>	<b>COUNTRY</b>
002115113	08/10/2012	OHIM

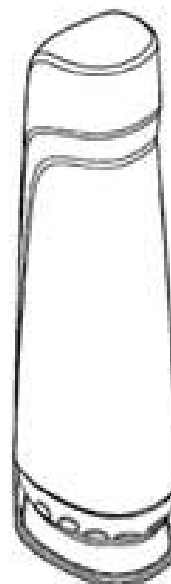

<b>DESIGN NUMBER</b>	251201	
<b>CLASS</b>	23-01	
<b>1)ALFA LAVAL CORPORATE AB, OF BOX 73, SE-221 00 LUND, SWEDEN</b>		
<b>DATE OF REGISTRATION</b>	24/01/2013	
<b>TITLE</b>	BUTTERFLY VALVE WITH HANDLE	
<b>PRIORITY</b>		
<b>PRIORITY NUMBER</b>	<b>DATE</b>	<b>COUNTRY</b>
002119958-0001	17/10/2012	OHIM

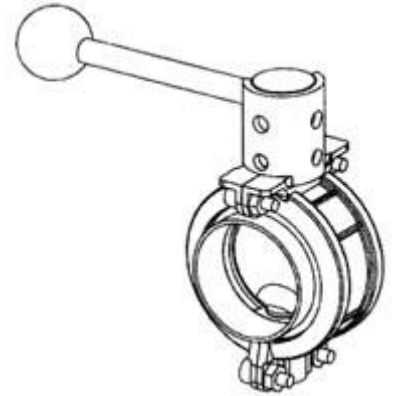



<b>DESIGN NUMBER</b>	254572	
<b>CLASS</b>	11-01	
<b>1)H. K JEWELS PVT. LTD. A COMPANY REGISTERED UNDER COMPANY ACT 1956 OF 1701-A, 17TH FLOOR, THE CAPITAL BUILDING, B-WING, OPP ICICI BANK, BANDRA KURLA COMPLEX, BANDRA (E), MUMBAI-400051, INDIA</b>		
<b>DATE OF REGISTRATION</b>	19/06/2013	
<b>TITLE</b>	RING	
<b>PRIORITY NA</b>		



<b>DESIGN NUMBER</b>	254700	
<b>CLASS</b>	06-13	
<b>1)SCI EXPORT (P) LTD., SITUATED AT WZ-NA-240, VISHNU GARDEN, NEW DELHI-110018 (INDIA) A COMPANY INCORPORATED UNDER THE INDIAN COMPANIES ACT, OF ABOVE ADDRESS</b>		
<b>DATE OF REGISTRATION</b>	24/06/2013	
<b>TITLE</b>	SOFA BACK COVER	
<b>PRIORITY NA</b>		



<b>DESIGN NUMBER</b>	254709	
<b>CLASS</b>	06-13	
<b>1)SCI EXPORT (P) LTD., SITUATED AT WZ-NA-240, VISHNU GARDEN, NEW DELHI-110018 (INDIA)</b> A COMPANY INCORPORATED UNDER THE INDIAN COMPANIES ACT, OF ABOVE ADDRESS		
<b>DATE OF REGISTRATION</b>	24/06/2013	
<b>TITLE</b>	SOFA BACK COVER	
<b>PRIORITY NA</b>		

<b>DESIGN NUMBER</b>	248459	
<b>CLASS</b>	08-06	
<b>1)SANVI ENTERPRISE, NATIONAL HIGH WAY</b> 8-B, OPP. PARIN FURNITURE, KOTHARIYA SOLVENT AREA, NEAR DHOKIYA MOTORS, KOTHARIYA, DIST: RAJKOT-360004, GUJARAT, INDIA, INDIAN COMPANY		
<b>DATE OF REGISTRATION</b>	04/10/2012	
<b>TITLE</b>	HANDLE	
<b>PRIORITY NA</b>		

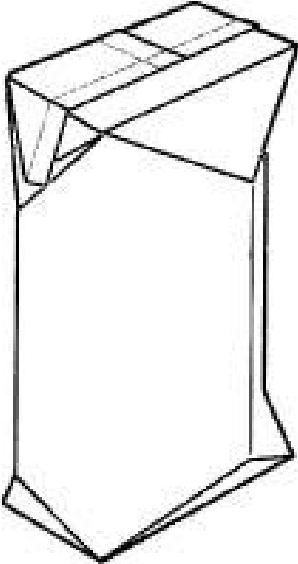
<b>DESIGN NUMBER</b>	250855		
<b>CLASS</b>	09-03		
<b>1)TETRA LAVAL HOLDINGS &amp; FINANCE S.A.,</b> 70, AVENUE GENERAL-GUISAN, PULLY, 1009 SWITZERLAND			
<b>DATE OF REGISTRATION</b>	08/01/2013		
<b>TITLE</b>	PACKAGING CONTAINER		
<b>PRIORITY</b>			
<b>PRIORITY NUMBER</b>	<b>DATE</b>	<b>COUNTRY</b>	
2012-016542	11/07/2012	JAPAN	

<b>DESIGN NUMBER</b>	250893	
<b>CLASS</b>	09-03	
<b>1)STOKELY-VAN CAMP, INC., INCORPORATED IN INDIANA OF</b> 555 WEST MONROE STREET, CHICAGO, ILLINOIS 60661, UNITED STATES OF AMERICA		
<b>DATE OF REGISTRATION</b>	09/01/2013	
<b>TITLE</b>	PACKAGING CONTAINER	
<b>PRIORITY</b>		
<b>PRIORITY NUMBER</b>	<b>DATE</b>	<b>COUNTRY</b>
29/426, 680	09/07/2012	U.S.A.

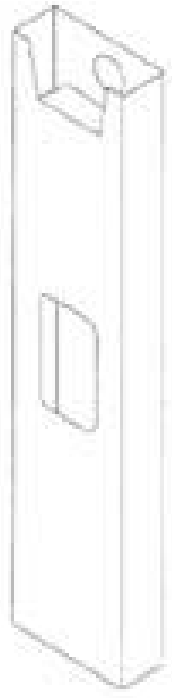

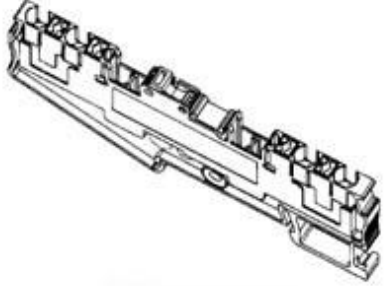

<b>DESIGN NUMBER</b>	249616	
<b>CLASS</b>	13-03	
<b>1)PHOENIX CONTACT GMBH &amp; CO. KG; A GERMAN COMPANY OF</b> BRUNO MUTH; FLACHSMARKTSTR. 8, D-32825 BLOMBERG, GERMANY		
<b>DATE OF REGISTRATION</b>	21/11/2012	
<b>TITLE</b>	ELECTRICAL CONNECTOR	
<b>PRIORITY</b>		
<b>PRIORITY NUMBER</b>	<b>DATE</b>	<b>COUNTRY</b>
002056028-0002	12/06/2012	OHIM



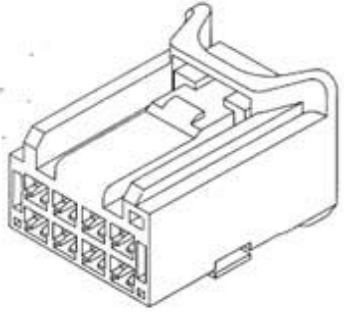

<b>DESIGN NUMBER</b>	253589	
<b>CLASS</b>	19-06	
<b>1)BHARAT KAVEDIYA, ADULT INDIAN, WHOSE ADDRESS IS</b> C-204, GOPI KISHAN NAGAR, RAVALPADA, DAHISAR (E), MUMBAI-400068, MAHARASHTRA, INDIA		
<b>DATE OF REGISTRATION</b>	30/04/2013	
<b>TITLE</b>	PENCIL BOX	
<b>PRIORITY NA</b>		



<b>DESIGN NUMBER</b>	241600		
<b>CLASS</b>	09-01		
<b>1)DABUR INDIA LIMITED CORPORATE OFFICE KAUSHANMBI, SAHIBABAD-201010, DISTT. GHAZIABAD (U.P.) INDIA.,</b>			
<b>DATE OF REGISTRATION</b>	20/12/2011		
<b>TITLE</b>	BOTTLE.		
<b>PRIORITY NA</b>			
<b>DESIGN NUMBER</b>	252258		
<b>CLASS</b>	13-03		
<b>1)YAZAKI CORPORATION, A JAPANESE CORPORATION OF 4-28, MITA 1-CHOME, MINATO-KU, TOKYO, JAPAN</b>			
<b>DATE OF REGISTRATION</b>	11/03/2013		
<b>TITLE</b>	HOUSING FOR ELECTRIC CONNECTOR		
<b>PRIORITY</b>			
<b>PRIORITY NUMBER</b>	<b>DATE</b>	<b>COUNTRY</b>	
2012-022226	13/09/2012	JAPAN	
<b>DESIGN NUMBER</b>	252346		
<b>CLASS</b>	08-06		
<b>1)MANISH KANJIBHAI CHOVIYA, INDIAN NATIONALITY, A SOLE PROPRIETOR OF M/S. SAFAR INDUSTRIES, HAVING HIS PRINCIPAL PLACE OF BUSINESS AT PLOT NO. 1, PATEL INDUSTRIAL AREA, BEHIND RIDDHI SIDDHI SOCIETY, NEAR OVER BRIDGE, GONDAL CHOKDI, BELOW DANDIA PUL, RAJKOT, GUJARAT STATE, INDIA</b>			
<b>DATE OF REGISTRATION</b>	15/03/2013		
<b>TITLE</b>	HANDLE		
<b>PRIORITY NA</b>			

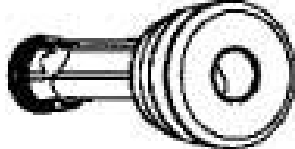

<b>DESIGN NUMBER</b>	248309	
<b>CLASS</b>	15-03	
<b>1)DELAVAL HOLDING AB; OF GUSTAF DE LAVALS VÄG 15, SE-147, TUMBA, SWEDEN</b>		
<b>DATE OF REGISTRATION</b>	01/10/2012	
<b>TITLE</b>	TEATCUP FOR MILKING MACHINES	
<b>PRIORITY NA</b>		

<b>DESIGN NUMBER</b>	251469		
<b>CLASS</b>	12-16		
<b>1)HONDA MOTOR CO., LTD., A JAPANESE CORPORATION, OF 1-1, MINAMI-AOYAMA 2-CHOME, MINATO-KU, TOKYO, JAPAN</b>			
<b>DATE OF REGISTRATION</b>	07/02/2013		
<b>TITLE</b>	FRONT TOP COVER FOR MOTOR SCOOTER		
<b>PRIORITY</b>			
<b>PRIORITY NUMBER</b>	<b>DATE</b>	<b>COUNTRY</b>	
2012-019518	13/08/2012	JAPAN	

<b>DESIGN NUMBER</b>	254079		
<b>CLASS</b>	13-99		
<b>1)INDER INDUSTRIES, A PARTNERSHIP FIRM, CONSTITUTED BY AND BETWEEN MR. DEVNDRA KUMAR JAIN AND ORCHID VINIMAY PVT. LTD., HAVING ADDRESS 301, SOBHNA APARTMENT, CHANDAWARKAR LANE, BORIVALI (W), MUMBAI-400092</b>			
<b>DATE OF REGISTRATION</b>	24/05/2013		
<b>TITLE</b>	ANGLE HOLDER		
<b>PRIORITY NA</b>			

<b>DESIGN NUMBER</b>	249302	
<b>CLASS</b>	09-07	
<b>1)MBF EMBALAGENS LTDA, A LIMITED LIABILITY COMPANY INCORPORATED UNDER THE LAWS OF BRAZIL, HAVING ITS ADDRESS AT RUA PIONEIRA MARIA CAVALCANTE RUY, 1449 LOTE 350C, 87065-090, MARINGA/PR, BRAZIL</b>		
<b>DATE OF REGISTRATION</b>	07/11/2012	
<b>TITLE</b>	DISPENSING CLOSURE	
<b>PRIORITY</b>		
<b>PRIORITY NUMBER</b>	<b>DATE</b>	<b>COUNTRY</b>
29/436,117	01/11/2012	U.S.A.





<b>DESIGN NUMBER</b>	251202	
<b>CLASS</b>	23-01	
<b>1)ALFA LAVAL CORPORATE AB, OF BOX 73, SE-221 00 LUND, SWEDEN</b>		
<b>DATE OF REGISTRATION</b>	24/01/2013	
<b>TITLE</b>	BUTTERFLY VALVE WITH ACTUATOR	
<b>PRIORITY</b>		
<b>PRIORITY NUMBER</b>	<b>DATE</b>	<b>COUNTRY</b>
002119958-0002	17/10/2012	OHIM



<b>DESIGN NUMBER</b>	252988	
<b>CLASS</b>	12-15	
<b>1)COMPAGNIE GENERALE DES ETABLISSEMENTS MICHELIN, A FRENCH COMPANY OF 12 COURS SABLON, FR-63000, CLERMONT-FERRAND, FRANCE, AND MICHELIN RECHERCHE ET TECHNIQUE S.A., A SWISS COMPANY OF ROUTE LOUIS- BRAILLE 10 - CH-1763 GRANGES-PACCOT,SWITZERLAND</b>		
<b>DATE OF REGISTRATION</b>	10/04/2013	
<b>TITLE</b>	TIRE TREAD	
<b>PRIORITY</b>		
<b>PRIORITY NUMBER</b>	<b>DATE</b>	<b>COUNTRY</b>
29/438,085	26/11/2012	U.S.A.

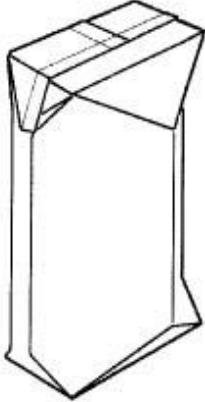

<b>DESIGN NUMBER</b>	254573	
<b>CLASS</b>	11-01	
<b>1)H. K JEWELS PVT. LTD. A COMPANY REGISTERED UNDER COMPANY ACT 1956 OF</b> 1701-A, 17TH FLOOR, THE CAPITAL BUILDING, B-WING, OPP ICICI BANK, BANDRA KURLA COMPLEX, BANDRA (E), MUMBAI-400051, INDIA		
<b>DATE OF REGISTRATION</b>	19/06/2013	
<b>TITLE</b>	RING	
<b>PRIORITY NA</b>		
<b>DESIGN NUMBER</b>	254701	
<b>CLASS</b>	06-13	
<b>1)SCI EXPORT (P) LTD., SITUATED AT WZ-NA-240, VISHNU GARDEN, NEW DELHI-110018 (INDIA)</b> A COMPANY INCORPORATED UNDER THE INDIAN COMPANIES ACT, OF ABOVE ADDRESS		
<b>DATE OF REGISTRATION</b>	24/06/2013	
<b>TITLE</b>	SOFA BACK COVER	
<b>PRIORITY NA</b>		
<b>DESIGN NUMBER</b>	254710	
<b>CLASS</b>	06-13	
<b>1)SCI EXPORT (P) LTD., SITUATED AT WZ-NA-240, VISHNU GARDEN, NEW DELHI-110018 (INDIA)</b> A COMPANY INCORPORATED UNDER THE INDIAN COMPANIES ACT, OF ABOVE ADDRESS		
<b>DATE OF REGISTRATION</b>	24/06/2013	
<b>TITLE</b>	SOFA BACK COVER	
<b>PRIORITY NA</b>		

<b>DESIGN NUMBER</b>	250856			
<b>CLASS</b>	09-03			
<b>1)TETRA LAVAL HOLDINGS &amp; FINANCE S.A., 70, AVENUE GENERAL-GUISAN, PULLY, 1009 SWITZERLAND</b>				
<b>DATE OF REGISTRATION</b>	08/01/2013			
<b>TITLE</b>	PACKAGING CONTAINER			
<b>PRIORITY</b>				
<b>PRIORITY NUMBER</b>	<b>DATE</b>	<b>COUNTRY</b>		
2012-016543	11/07/2012	JAPAN		
<b>PRIORITY NA</b>				
<b>PRIORITY NA</b>				
<b>DESIGN NUMBER</b>	254541			
<b>CLASS</b>	11-01			
<b>1)H. K JEWELS PVT. LTD. A COMPANY REGISTERED UNDER COMPANY ACT 1956 OF 1701-A, 17TH FLOOR, THE CAPITAL BUILDING, B-WING, OPP ICICI BANK, BANDRA KURLA COMPLEX, BANDRA (E), MUMBAI-400051, INDIA</b>				
<b>DATE OF REGISTRATION</b>	18/06/2013			
<b>TITLE</b>	NECKLACE			
<b>PRIORITY NA</b>				
<b>PRIORITY NA</b>				
<b>DESIGN NUMBER</b>	248241			
<b>CLASS</b>	09-01			
<b>1) AGUAS DE SOLAN DE CABRAS, S.A. COMPANY ORGANIZED AND EXISTING IN SPAIN HAVING REGISTERED OFFICE AT 16870, BETETA, PARAJE DE SOLAN DE CABRAS, CUENCA, SPAIN</b>				
<b>DATE OF REGISTRATION</b>	27/09/2012			
<b>TITLE</b>	BOTTLE			
<b>PRIORITY NA</b>				
<b>PRIORITY NA</b>				
<b>PRIORITY NA</b>				
<b>PRIORITY NA</b>				
<b>PRIORITY NA</b>				

<b>DESIGN NUMBER</b>	250802	
<b>CLASS</b>	12-05	
<b>1)MITSUBISHI NICHYU FORKLIFT CO., LTD., A JAPANESE CORPORATION OF</b> 1-1, 2-CHOME, HIGASHIKOTARI, NAGAOKAKYO-SHI, KYOTO, 617-8585, JAPAN		
<b>DATE OF REGISTRATION</b>	07/01/2013	
<b>TITLE</b>	FORKLIFT	
<b>PRIORITY</b>		
<b>PRIORITY NUMBER</b>	<b>DATE</b>	<b>COUNTRY</b>
2012-016674	12/07/2012	JAPAN

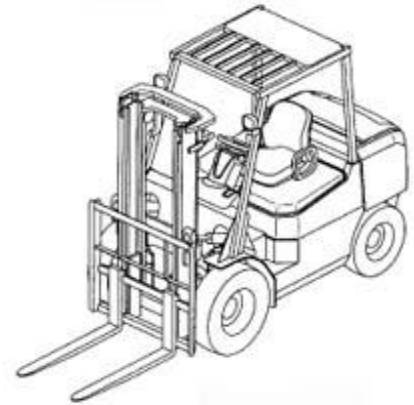

<b>DESIGN NUMBER</b>	251581	
<b>CLASS</b>	15-03	
<b>1)NEW SWAN ENTERPRISES (AGRO DIVISION) OF C-213, PHASE-VIII, FOCAL POINT, LUDHIANA (PUNJAB), INDIA,</b> AN INDIAN PROPRIETORSHIP FIRM, WHOSE PROPRIETOR IS S. UPKAR SINGH AHUJA, INDIAN NATIONAL OF ABOVE ADDRESS		
<b>DATE OF REGISTRATION</b>	11/02/2013	
<b>TITLE</b>	AGRICULTURAL ROTAVETOR	
<b>PRIORITY NA</b>		





<b>DESIGN NUMBER</b>	253710	
<b>CLASS</b>	12-11	
<b>1)TUBE INVESTMENTS OF INDIA LIMITED, AN INDIAN COMPANY INCORPORATED UNDER THE COMPANIES ACT OF 1956, HAVING ITS PRINCIPAL PLACE OF BUSINESS AT</b> "DARE HOUSE", 234, N. S. C. BOSE ROAD, CHENNAI - 600001, STATE OF TAMIL NADU, INDIA		
<b>DATE OF REGISTRATION</b>	07/05/2013	
<b>TITLE</b>	BASKET FOR BICYCLE	
<b>PRIORITY NA</b>		





No. of SI

<b>DESIGN NUMBER</b>	250521	
<b>CLASS</b>	06-01	
<b>1)PRIMA PLASTICS LTD., A COMPANY INCORPORATED UNDER THE INDIAN COMPANIES ACT, AT</b> 41, NATIONAL HOUSE, OPP ANSA INDL ESTATE, A BIDG, SAKI - VIHAR ROAD, POWAI, ANDHERI (E), MUMBAI - 400072		
<b>DATE OF REGISTRATION</b>	28/12/2012	
<b>TITLE</b>	ROCKING CHAIR	
<b>PRIORITY NA</b>		



<b>DESIGN NUMBER</b>	251284	
<b>CLASS</b>	24-01	
<b>1)GE MEDICAL SYSTEMS GLOBAL TECHNOLOGY COMPANY, LLC A DELAWARE LIMITED LIABILITY COMPANY INCORPORATED UNDER THE LAWS OF UNITED STATES OF AMERICA HAVING ITS OFFICE AT</b> 3000 NORTH GRANDVIEW BOULEVARD-W-710, WAUKESHA, WI 53188, UNITED STATES OF AMERICA		
<b>DATE OF REGISTRATION</b>	29/01/2013	
<b>TITLE</b>	EXPOSURE SWITCH FOR X-RAY IMAGING SYSTEM	
<b>PRIORITY</b>		
<b>PRIORITY NUMBER</b>	<b>DATE</b>	<b>COUNTRY</b>
201230409295.X	28/08/2012	CHINA

<b>DESIGN NUMBER</b>	243755	
<b>CLASS</b>	09-01	
<b>1)RADICO KHAITAN LIMITED</b> PLOT NO. J-1, BLOCK B-1, MOHAN CO-OP INDUSTRIAL AREA, MATHURA ROAD, NEW DELHI 110044, INDIA		
<b>DATE OF REGISTRATION</b>	09/03/2012	
<b>TITLE</b>	BOTTLE	
<b>PRIORITY NA</b>		

<b>DESIGN NUMBER</b>	249049		
<b>CLASS</b>	08-06		
<b>1)JEYANTIBHAI DAHYABHAI PIPALIYA (ADULT AND INDIAN NATIONAL) SOLE PROPRIETOR OF AVADH MANUFACTURE (INDIAN PROPRIETORSHIP CONCERN) HAVING PLACE OF BUSINESS</b> AT: 1, PATEL NAGAR, NR. RAJARAM TEMPLE, KOTHARIYA MAIN ROAD, RAJKOT-360002-GUJARAT (INDIA)			
<b>DATE OF REGISTRATION</b>	29/10/2012		
<b>TITLE</b>	HANDLE		
<b>PRIORITY NA</b>			
<b>DESIGN NUMBER</b>	249125		
<b>CLASS</b>	26-05		
<b>1)FLOS S.P.A., AN ITALIAN COMPANY,</b> VIA A. FAINI, 2, I-25073 BOVEZZO, BRESCIA, ITALY			
<b>DATE OF REGISTRATION</b>	31/10/2012		
<b>TITLE</b>	FLOOR LAMP		
<b>PRIORITY</b>			
<b>PRIORITY NUMBER</b>	<b>DATE</b>	<b>COUNTRY</b>	
BS2012O000025	14/09/2012	ITALY	
<b>DESIGN NUMBER</b>	251185		
<b>CLASS</b>	12-08		
<b>1)TOYOTA JIDOSHA KABUSHIKI KAISHA, A JAPANESE CO., OF</b> 1, TOYOTA-CHO, TOYOTA-SHI, AICHI-KEN, 471-8571, JAPAN			
<b>DATE OF REGISTRATION</b>	24/01/2013		
<b>TITLE</b>	CAR		
<b>PRIORITY</b>			
<b>PRIORITY NUMBER</b>	<b>DATE</b>	<b>COUNTRY</b>	
2012-017839	27/07/2012	JAPAN	

<b>DESIGN NUMBER</b>	254570	
<b>CLASS</b>	11-01	
<b>1)H. K JEWELS PVT. LTD. A COMPANY REGISTERED UNDER COMPANY ACT 1956 OF</b> 1701-A, 17TH FLOOR, THE CAPITAL BUILDING, B-WING, OPP ICICI BANK, BANDRA KURLA COMPLEX, BANDRA (E), MUMBAI-400051, INDIA		
<b>DATE OF REGISTRATION</b>	19/06/2013	
<b>TITLE</b>	PENDANT	
<b>PRIORITY NA</b>		
<b>DESIGN NUMBER</b>	254698	
<b>CLASS</b>	06-13	
<b>1)SCI EXPORT (P) LTD., SITUATED AT WZ-NA-240, VISHNU GARDEN, NEW DELHI-110018 (INDIA)</b> A COMPANY INCORPORATED UNDER THE INDIAN COMPANIES ACT, OF ABOVE ADDRESS		
<b>DATE OF REGISTRATION</b>	24/06/2013	
<b>TITLE</b>	SOFA BACK COVER	
<b>PRIORITY NA</b>		
<b>DESIGN NUMBER</b>	254707	
<b>CLASS</b>	06-13	
<b>1)SCI EXPORT (P) LTD., SITUATED AT WZ-NA-240, VISHNU GARDEN, NEW DELHI-110018 (INDIA)</b> A COMPANY INCORPORATED UNDER THE INDIAN COMPANIES ACT, OF ABOVE ADDRESS		
<b>DATE OF REGISTRATION</b>	24/06/2013	
<b>TITLE</b>	SOFA BACK COVER	
<b>PRIORITY NA</b>		

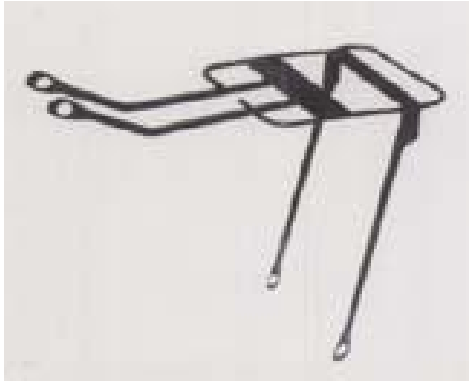

<b>DESIGN NUMBER</b>	248456	
<b>CLASS</b>	08-06	
<b>1)SANVI ENTERPRISE, NATIONAL HIGH WAY</b> 8-B, OPP. PARIN FURNITURE, KOTHARIYA SOLVENT AREA, NEAR DHOKIYA MOTORS, KOTHARIYA, DIST: RAJKOT-360004, GUJARAT, INDIA, INDIAN COMPANY		
<b>DATE OF REGISTRATION</b>	04/10/2012	
<b>TITLE</b>	HANDLE	
<b>PRIORITY NA</b>		
<b>DESIGN NUMBER</b>	248570	
<b>CLASS</b>	12-11	
<b>1)EASTMAN INDUSTRIES LIMITED, C-87, PHASE-V, FOCAL POINT,</b> <b>LUDHIANA-141010 (PUNJAB) INDIA</b> (AN INDIAN COMPANY DULY REGISTERED UNDER THE COMPANIES ACT, 1956) OF THE ABOVE ADDRESS		
<b>DATE OF REGISTRATION</b>	05/10/2012	
<b>TITLE</b>	CARRIER FOR BICYCLE	
<b>PRIORITY NA</b>		
<b>DESIGN NUMBER</b>	248658	
<b>CLASS</b>	19-06	
<b>1)KAMLESH RAVJI DUBARIYA AN INDIVIDUAL-INDIAN</b> <b>RESIDENT OF,</b> GALA NO. 04 D, MELLO COMPOUND, ROAD NO. 11, SUBHASH NAGAR M.I.D.C., NEAR LAL MASJID, ANDHERI (EAST), MUMBAI- 400093 MAHARASHTRA, INDIA		
<b>DATE OF</b> <b>REGISTRATION</b>	09/10/2012	
<b>TITLE</b>	STATIONERY ITEM	
<b>PRIORITY NA</b>		

<b>DESIGN NUMBER</b>	250847	
<b>CLASS</b>	06-01	
<b>1)ITALICA FURNITURE PRIVATE LIMITED, E-260-261, M I A, UDAIPUR, INDIA, AN INDIAN COMPANY</b>		
<b>DATE OF REGISTRATION</b>	08/01/2013	
<b>TITLE</b>	CHAIR	
<b>PRIORITY NA</b>		

<b>DESIGN NUMBER</b>	252102	
<b>CLASS</b>	09-03	
<b>1)DINESH BASTIMAL JAIN (AN INDIAN NATIONAL) AT 203/204 RAJ MADHUR CHS. DEVIDAS LANE, NR. CLUB AQUERIA, BORIVALI (WEST) MUMBAI 400103, STATE OF MAHARASHTRA, INDIA</b>		
<b>DATE OF REGISTRATION</b>	05/03/2013	
<b>TITLE</b>	BOX FOR COSMETICS	
<b>PRIORITY NA</b>		

<b>DESIGN NUMBER</b>	253858	
<b>CLASS</b>	13-03	
<b>1)AJANTA LIMITED, AN INDIAN COMPANY OF ORPAT INDUSTRIAL ESTATE, RAJKOT-MORBI HIGHWAY, MORBI 363641, STATE OF GUJARAT, INDIA</b>		
<b>DATE OF REGISTRATION</b>	15/05/2013	
<b>TITLE</b>	SWITCH	
<b>PRIORITY NA</b>		

<b>DESIGN NUMBER</b>	253520	
<b>CLASS</b>	13-03	
<b>1)GOLD MEDAL ELECTRICALS PVT. LTD. A COMPANY REGISTERED UNDER COMPANY ACT 1956 WHOSE ADDRESS IS, A/302, KEMP PLAZA, MIND SPACE, OFF LINK ROAD, CHINCHOLI BUNDER, MALAD (WEST), MUMBAI-400064, MAHARASHTRA, INDIA</b>		
<b>DATE OF REGISTRATION</b>	30/04/2013	
<b>TITLE</b>	SWITCH COVER PLATE	
<b>PRIORITY NA</b>		

<b>DESIGN NUMBER</b>	254397	
<b>CLASS</b>	12-11	
<b>1)HONDA MOTOR CO., LTD., A JAPANESE CORPORATION, OF 1-1, MINAMI-AOYAMA 2-CHOME, MINATO-KU, TOKYO, JAPAN</b>		
<b>DATE OF REGISTRATION</b>	10/06/2013	
<b>TITLE</b>	MOTORCYCLE	
<b>PRIORITY</b>		
<b>PRIORITY NUMBER</b>	<b>DATE</b>	<b>COUNTRY</b>
2012-031313	24/12/2012	JAPAN

<b>DESIGN NUMBER</b>	250620	
<b>CLASS</b>	12-08	
<b>1)MAN TRUCK &amp; BUS AG, A GERMAN COMPANY OF DACHAUER STR. 667, 80995 MÜNICH, GERMANY</b>		
<b>DATE OF REGISTRATION</b>	03/01/2013	
<b>TITLE</b>	DRIVERS CAB OF A UTILITY VEHICLE	
<b>PRIORITY</b>		
<b>PRIORITY NUMBER</b>	<b>DATE</b>	<b>COUNTRY</b>
001335236	04/07/2012	OHIM

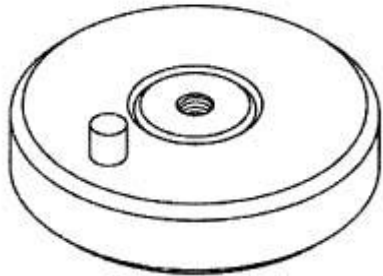
<b>DESIGN NUMBER</b>	251383	
<b>CLASS</b>	08-08	
<b>1)OOPARTS, INC., NATIONALITY: JAPAN ADDRESS AT</b> 1643-28, SHUKU, SOJA-SHI, OKAYAMA 719-1161 JAPAN		
<b>DATE OF REGISTRATION</b>	04/02/2013	
<b>TITLE</b>	BASE MEMBER OF FASTENING DEVICE	
<b>PRIORITY NA</b>		

<b>DESIGN NUMBER</b>	249048	
<b>CLASS</b>	08-06	
<b>1)LALJIBHAI PANCHABHAI ROKAD (INDIAN NATIONAL) PROPRIETOR OF</b> <b>SITARAM METAL (INDIAN PROPRIETORSHIP CONCERN) HAVING PLACE</b> <b>OF BUSINESS</b> AT: 3, PATEL NAGAR, 80 FEET ROAD, OPP: PATEL TOOLS, RAJKOT-360002 - GUJARAT (INDIA)		
<b>DATE OF REGISTRATION</b>	29/10/2012	
<b>TITLE</b>	HANDLE	
<b>PRIORITY NA</b>		

<b>DESIGN NUMBER</b>	253143	
<b>CLASS</b>	14-02	
<b>1)LG ELECTRONICS INC.,</b> 20 YEOUIDO-DONG YEONGDEUNGPO - GU SEOUL, 150-721 REPUBLIC OF KOREA, A CORPORATION INCORPORATED UNDER THE LAWS OF THE REPUBLIC OF KOREA		
<b>DATE OF REGISTRATION</b>	12/04/2013	
<b>TITLE</b>	MONITOR	
<b>PRIORITY</b>		
<b>PRIORITY NUMBER</b>	<b>DATE</b>	<b>COUNTRY</b>
30-2012-0051420	29/10/2012	REPUBLIC OF KOREA

<b>DESIGN NUMBER</b>	254706	
<b>CLASS</b>	06-13	
<b>1)SCI EXPORT (P) LTD., SITUATED AT WZ-NA-240, VISHNU GARDEN, NEW DELHI-110018 (INDIA)</b> A COMPANY INCORPORATED UNDER THE INDIAN COMPANIES ACT, OF ABOVE ADDRESS		
<b>DATE OF REGISTRATION</b>	24/06/2013	
<b>TITLE</b>	SOFA BACK COVER	
<b>PRIORITY NA</b>		
<b>DESIGN NUMBER</b>	254764	
<b>CLASS</b>	11-01	
<b>1)H. K JEWELS PVT. LTD. A COMPANY REGISTERED UNDER COMPANY ACT 1956 OF</b> 1701-A, 17TH FLOOR, THE CAPITAL BUILDING, B-WING, OPP ICICI BANK, BANDRA KURLA COMPLEX, BANDRA (E), MUMBAI-400051, INDIA		
<b>DATE OF REGISTRATION</b>	25/06/2013	
<b>TITLE</b>	PENDANT	
<b>PRIORITY NA</b>		
<b>DESIGN NUMBER</b>	248445	
<b>CLASS</b>	09-03	
<b>1)DHARAMPAL SATYAPAL LTD, HAVING THE REGISTERED OFFICE AT</b> 1711 S.P MUKHERJEE MARG, NEW DELHI-6, PIN 110006, AN INDIAN COMPANY		
<b>DATE OF REGISTRATION</b>	03/10/2012	
<b>TITLE</b>	PACKAGING CONTAINER	
<b>PRIORITY NA</b>		

<b>DESIGN NUMBER</b>	250874	
<b>CLASS</b>	09-05	
<b>1)COLGATE-PALMOLIVE COMPANY, A DELAWARE CORPORATION, 300 PARK AVENUE, NEW YORK, NEW YORK 10022, USA</b>		
<b>DATE OF REGISTRATION</b>	08/01/2013	
<b>TITLE</b>	ORAL CARE IMPLEMENT PACKAGE	
<b>PRIORITY</b>		
<b>PRIORITY NUMBER</b>	<b>DATE</b>	<b>COUNTRY</b>
29/427,592	19/07/2012	U.S.A.

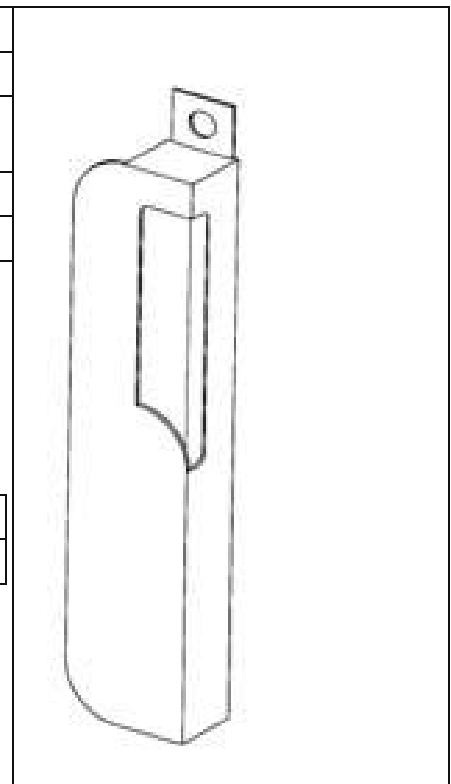

<b>DESIGN NUMBER</b>	253944	
<b>CLASS</b>	02-04	
<b>1)GANESH FOOTWEARS, H-44, UDYOG NAGAR, PEERAGARHI, DELHI-110041, INDIA.</b> (AN INDIAN PROPRIETORSHIP FIRM WHOSE PROPRIETOR IS:- SH. GANESH PRASAD AGGARWAL. AN INDIAN NATIONAL OF THE ABOVE ADDRESS		
<b>DATE OF REGISTRATION</b>	17/05/2013	
<b>TITLE</b>	SHOE	
<b>PRIORITY NA</b>		



<b>DESIGN NUMBER</b>	225931	
<b>CLASS</b>	12-16	
<b>1)HENDRICKSON USA, L.L.C.</b> 500 PARK BOULEVARD, SUITE 1010, ITASCA, ILLINOIS 60143-1285, UNITED STATE OF AMERICA.		
<b>DATE OF REGISTRATION</b>	26/11/2009	
<b>TITLE</b>	SPRING HOUSING FOR A SUSPENSION	
<b>PRIORITY</b>		
<b>PRIORITY NUMBER</b>	<b>DATE</b>	<b>COUNTRY</b>
29/337, 985	02/06/2009	U.S.A.

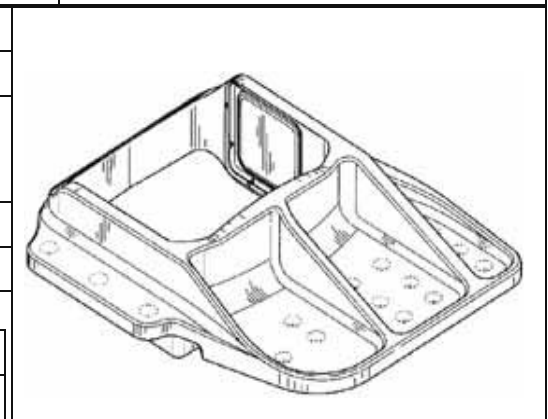

<b>DESIGN NUMBER</b>	254384	
<b>CLASS</b>	08-06	
<b>1)SHOBHNABEN R BARASIYA (INDIAN NATIONALS) AND SOLE PROPRIETOR OF SURAJ METAL (INDIAN PROPRIETARY CONCERN) HAVING PLACE OF BUSINESS</b> AT-4, PARSANA SOCIETY, NR. 73, SCHOOL RAJKOT-GUJARAT (INDIA)		
<b>DATE OF REGISTRATION</b>	07/06/2013	
<b>TITLE</b>	HANDLE	
<b>PRIORITY NA</b>		
<b>DESIGN NUMBER</b>	254435	
<b>CLASS</b>	09-03	
<b>1)PEARL THERMOPLAST PVT. LTD., A COMPANY INCORPORATED UNDER THE INDIAN COMPANIES ACT, AT PLOT NO. 22, S. NO.820(1), DEWAN &amp; SONS UDYOG NAGAR, CHINTUPADA, PALGHAR(W), THANE-401401, MAHARASHTRA, INDIA.</b>		
<b>DATE OF REGISTRATION</b>	11/06/2013	
<b>TITLE</b>	CASSEROLE	
<b>PRIORITY NA</b>		
<b>DESIGN NUMBER</b>	254569	
<b>CLASS</b>	11-01	
<b>1)H. K JEWELS PVT. LTD. A COMPANY REGISTERED UNDER COMPANY ACT 1956 OF</b> 1701-A, 17TH FLOOR, THE CAPITAL BUILDING, B-WING, OPP ICICI BANK, BANDRA KURLA COMPLEX, BANDRA (E), MUMBAI-400051, INDIA		
<b>DATE OF REGISTRATION</b>	19/06/2013	
<b>TITLE</b>	RING	
<b>PRIORITY NA</b>		

<b>DESIGN NUMBER</b>	250618	
<b>CLASS</b>	12-08	
<b>1)MAN TRUCK &amp; BUS AG, A GERMAN COMPANY OF DACHAUER STR. 667, 80995 MÜNICH, GERMANY</b>		
<b>DATE OF REGISTRATION</b>	03/01/2013	
<b>TITLE</b>	DRIVERS CAB OF A UTILITY VEHICLE	
<b>PRIORITY</b>		
<b>PRIORITY NUMBER</b>	<b>DATE</b>	<b>COUNTRY</b>
001335236	04/07/2012	OHIM



<b>DESIGN NUMBER</b>	250747	
<b>CLASS</b>	12-08	
<b>1)FORD GLOBAL TECHNOLOGIES, LLC A COMPANY ORGANIZED AND EXISTING UNDER THE LAWS OF UNITED STATES OF AMERICA, HAVING ITS OFFICE AT SUITE 800, 330 TOWN CENTRE DRIVE, DEARBORN MICHIGAN- 48126, UNITED STATES OF AMERICA</b>		
<b>DATE OF REGISTRATION</b>	04/01/2013	
<b>TITLE</b>	AUTOMOBILE	
<b>PRIORITY</b>		
<b>PRIORITY NUMBER</b>	<b>DATE</b>	<b>COUNTRY</b>
402012100598.7	02/08/2012	GERMANY

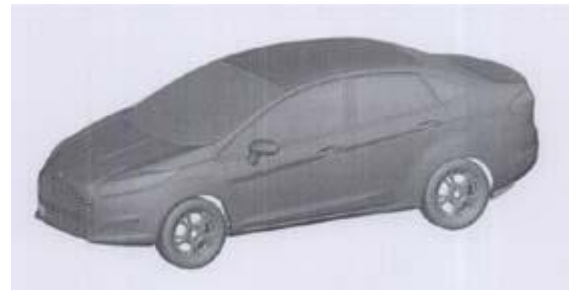

<b>DESIGN NUMBER</b>	251542	
<b>CLASS</b>	12-05	
<b>1)MARTIN ENGINEERING COMPANY, A CORPORATION OF THE STATE OF ILLINOIS, OF ONE MARTIN PLACE, NEPONSET, IL 61345, UNITED STATES OF AMERICA</b>		
<b>DATE OF REGISTRATION</b>	08/02/2013	
<b>TITLE</b>	CONVEYOR SCRAPER BLADE TIP	
<b>PRIORITY</b>		
<b>PRIORITY NUMBER</b>	<b>DATE</b>	<b>COUNTRY</b>
29/429, 329	09/08/2012	U.S.A.

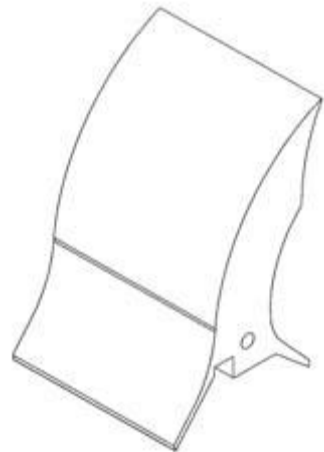



<b>DESIGN NUMBER</b>	251637	
<b>CLASS</b>	16-01	
<b>1)JVC KENWOOD CORPORATION, A JAPANESE CORPORATION OF</b> 3-12, MORIYACHO, KANAGAWA-KU, YOKOHAMA-SHI, KANAGAWA, 221-0022, JAPAN		
<b>DATE OF REGISTRATION</b>	14/02/2013	
<b>TITLE</b>	CAMCORDER	
<b>PRIORITY</b>		
<b>PRIORITY NUMBER</b>	<b>DATE</b>	<b>COUNTRY</b>
2012-022327	14/09/2012	JAPAN



<b>DESIGN NUMBER</b>	253707	
<b>CLASS</b>	12-11	
<b>1)TUBE INVESTMENTS OF INDIA LIMITED, AN INDIAN</b> <b>COMPANY INCORPORATED UNDER THE COMPANIES ACT</b> <b>OF 1956, HAVING ITS PRINCIPAL PLACE OF BUSINESS AT</b> ‘DARE HOUSE’, 234, N. S. C. BOSE ROAD, CHENNAI - 600001, STATE OF TAMIL NADU, INDIA		
<b>DATE OF REGISTRATION</b>	07/05/2013	
<b>TITLE</b>	CHAIN COVER FOR BICYCLE	
<b>PRIORITY NA</b>		



<b>DESIGN NUMBER</b>	248904	
<b>CLASS</b>	08-05	
<b>1)GODREJ &amp; BOYCE MFG. CO. LTD., COMPANY</b> <b>REGISTERED UNDER THE LAWS OF INDIA HAVING ITS</b> <b>PLACE OF BUSINESS AT</b> NO. 1, SIDCO INDUSTRIALESTATE, AMBATTUR, CHENNAI- 600098, INDIA		
<b>DATE OF REGISTRATION</b>	19/10/2012	
<b>TITLE</b>	PALLET FOR ENTRY OF GOODS	
<b>PRIORITY NA</b>		



<b>DESIGN NUMBER</b>	251277		
<b>CLASS</b>	28-02		
<b>1)ELC MANAGEMENT LLC, A DELAWARE CORPORATION, HAVING AN OFFICE AT</b> 155 PINELAWN ROAD, SUITE 345 SOUTH, MELVILLE, NY 11747, USA			
<b>DATE OF REGISTRATION</b>	29/01/2013		
<b>TITLE</b>	COSMETIC CONTAINER		
<b>PRIORITY</b>			
<b>PRIORITY NUMBER</b>	<b>DATE</b>	<b>COUNTRY</b>	
29/428,697	02/08/2012	U.S.A.	
<b>DESIGN NUMBER</b>	251402		
<b>CLASS</b>	23-01		
<b>1)M/S. AQUIONICS DEVELOPMENTS INDIA (P) LTD., WHOSE ADDRESS</b> UG-5, WEST END MALL, JANAK PLACE, JANAK PURI, NEW DELHI-110058, INDIAN			
<b>DATE OF REGISTRATION</b>	05/02/2013		
<b>TITLE</b>	WATER SOFTENER VESSEL		
<b>PRIORITY NA</b>			
<b>DESIGN NUMBER</b>	253227		
<b>CLASS</b>	12-16		
<b>1)MINDA INDUSTRIES LIMITED., AN INDIAN COMPANY OF</b> VILL. NAWADA FATEPUR, P.O. SIKANDERPUR BADDI, MANESAR, DISTT. GURGAON, HARYANA-122004, INDIA			
<b>DATE OF REGISTRATION</b>	18/04/2013		
<b>TITLE</b>	MODULAR SWITCH FOR VEHICLE		
<b>PRIORITY NA</b>			

<b>DESIGN NUMBER</b>	253373	
<b>CLASS</b>	10-04	
<b>1)KABUSHIKI KAISHA TOSHIBA, A JAPANESE CORPORATION, OF 1-1, SHIBAURA 1-CHOME, MINATO-KU, TOKYO, JAPAN</b>		
<b>DATE OF REGISTRATION</b>	23/04/2013	
<b>TITLE</b>	ELECTRONIC CLINICAL THERMOMETER	
<b>PRIORITY</b>		
<b>PRIORITY NUMBER</b>	<b>DATE</b>	<b>COUNTRY</b>
2012-026969	06/11/2012	JAPAN





<b>DESIGN NUMBER</b>	254231	
<b>CLASS</b>	12-16	
<b>1)MAHINDRA &amp; MAHINDRA LTD., A COMPANY INCORPORATED UNDER THE INDIAN COMPANIES ACT, 1913 OF GATEWAY BUILDING, APOLLO BUNDER, MUMBAI 400001, MAHARASHTRA, INDIA</b>		
<b>DATE OF REGISTRATION</b>	31/05/2013	
<b>TITLE</b>	WHEEL CAP	
<b>PRIORITY NA</b>		

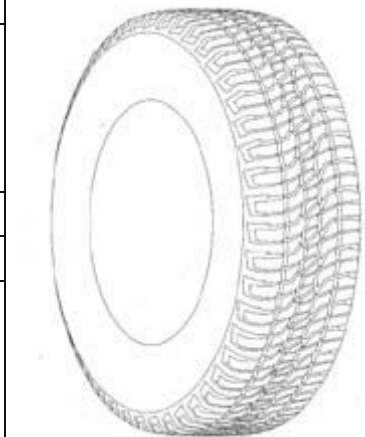

<b>DESIGN NUMBER</b>	252936	
<b>CLASS</b>	12-15	
<b>1)COMPAGNIE GENERALE DES ETABLISSEMENTS MICHELIN, A FRENCH COMPANY OF 12 COURS SABLON, FR-63000, CLERMONT-FERRAND, FRANCE, AND MICHELIN RECHERCHE ET TECHNIQUE S.A., A SWISS COMPANY OF ROUTE LOUIS BRAILLE 10-CH-1763, GRANGES-PACCOT, SWITZERLAND</b>		
<b>DATE OF REGISTRATION</b>	08/04/2013	
<b>TITLE</b>	TIRE	
<b>PRIORITY</b>		
<b>PRIORITY NUMBER</b>	<b>DATE</b>	<b>COUNTRY</b>
29/435,468	24/10/2012	U.S.A.



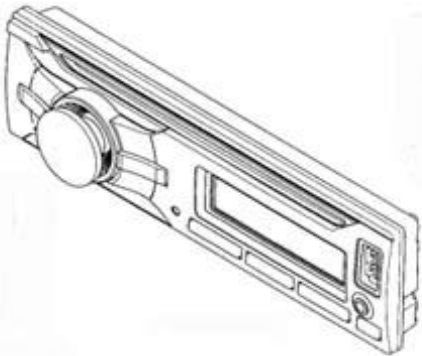



<b>DESIGN NUMBER</b>	254704		
<b>CLASS</b>	06-13		
<b>1)SCI EXPORT (P) LTD., SITUATED AT WZ-NA-240, VISHNU GARDEN, NEW DELHI-110018 (INDIA)</b> A COMPANY INCORPORATED UNDER THE INDIAN COMPANIES ACT, OF ABOVE ADDRESS			
<b>DATE OF REGISTRATION</b>	24/06/2013		
<b>TITLE</b>	SOFA BACK COVER		
<b>PRIORITY NA</b>			
<b>DESIGN NUMBER</b>	254759		
<b>CLASS</b>	11-01		
<b>1)H. K JEWELS PVT. LTD. A COMPANY REGISTERED UNDER COMPANY ACT 1956 OF</b> 1701-A, 17TH FLOOR, THE CAPITAL BUILDING, B-WING, OPP ICICI BANK, BANDRA KURLA COMPLEX, BANDRA (E), MUMBAI-400051, INDIA			
<b>DATE OF REGISTRATION</b>	25/06/2013		
<b>TITLE</b>	PENDANT		
<b>PRIORITY NA</b>			
<b>DESIGN NUMBER</b>	254803		
<b>CLASS</b>	14-01		
<b>1)LG ELECTRONICS INC., 20 YEOUIDO-DONG YEONGDEUNGPO - GU SEOUL, 150-721 REPUBLIC OF KOREA,</b> A CORPORATION INCORPORATED UNDER THE LAWS OF THE REPUBLIC OF KOREA			
<b>DATE OF REGISTRATION</b>	25/06/2013		
<b>TITLE</b>	CAR AUDIO		
<b>PRIORITY</b>			
<b>PRIORITY NUMBER</b>	<b>DATE</b>	<b>COUNTRY</b>	
30-2012-0062620	27/12/2012	REPUBLIC OF KOREA	

<b>DESIGN NUMBER</b>	250973	
<b>CLASS</b>	28-02	
<b>1)ITC LIMITED, AN INDIAN COMPANY WITHIN THE MEANING OF THE COMPANIES ACT, 1956 OF VIRGINIA HOUSE, 37, J. L. NEHRU ROAD, KOLKATA - 700071, WEST BENGAL, INDIA</b>		
<b>DATE OF REGISTRATION</b>	14/01/2013	
<b>TITLE</b>	SOAP BAR	
<b>PRIORITY NA</b>		
<b>DESIGN NUMBER</b>	252107	
<b>CLASS</b>	09-03	
<b>1)DINESH BASTIMAL JAIN (AN INDIAN NATIONAL) AT 203/204 RAJ MADHUR CHS. DEVIDAS LANE, NR. CLUB AQUERIA, BORIVALI (WEST) MUMBAI 400103, STATE OF MAHARASHTRA, INDIA</b>		
<b>DATE OF REGISTRATION</b>	05/03/2013	
<b>TITLE</b>	CONTAINER	
<b>PRIORITY NA</b>		
<b>DESIGN NUMBER</b>	248115	
<b>CLASS</b>	07-02	
<b>1)NARENDIRAN REDDY SIMMACHALAM AT 12/379, 13TH CROSS STREET, PHASE - 1, SATHUVACHAARI, VELLORE-632009, INDIA</b>		
<b>DATE OF REGISTRATION</b>	24/09/2012	
<b>TITLE</b>	COOKING PLATE	
<b>PRIORITY NA</b>		

<b>DESIGN NUMBER</b>	254407	
<b>CLASS</b>	02-07	
<b>1)DEVSARIA IMPEX PVT. LTD. D-119, SECTOR-4, BAWANA INDL. AREA, NEW DELHI-110030, INDIA</b> (AN INDIAN COMPANY DULY REGISTERED UNDER THE COMPANIES ACT, 1956)		
<b>DATE OF REGISTRATION</b>	10/06/2013	
<b>TITLE</b>	ZIP SLIDER	
<b>PRIORITY NA</b>		



<b>DESIGN NUMBER</b>	254567	
<b>CLASS</b>	11-01	
<b>1)H. K JEWELS PVT. LTD. A COMPANY REGISTERED UNDER COMPANY ACT 1956 OF</b> 1701-A, 17TH FLOOR, THE CAPITAL BUILDING, B-WING, OPP ICICI BANK, BANDRA KURLA COMPLEX, BANDRA (E), MUMBAI-400051, INDIA		
<b>DATE OF REGISTRATION</b>	19/06/2013	
<b>TITLE</b>	RING	
<b>PRIORITY NA</b>		

<b>DESIGN NUMBER</b>	250063	
<b>CLASS</b>	12-11	
<b>1)SRISHTI SCHOOL OF ART, DESIGN AND TECHNOLOGY OF</b> P.O. BOX 6430, YELAHANKA NEW TOWN, BANGALORE, 560106, NATIONALITY OF THE APPLICANT IS INDIAN		
<b>DATE OF REGISTRATION</b>	11/12/2012	
<b>TITLE</b>	CARGO SCOOTER	
<b>PRIORITY NA</b>		

<b>DESIGN NUMBER</b>	250619		
<b>CLASS</b>	12-08		
<b>1)MAN TRUCK &amp; BUS AG, A GERMAN COMPANY OF DACHAUER STR. 667, 80995 MÜNICH, GERMANY</b>			
<b>DATE OF REGISTRATION</b>	03/01/2013		
<b>TITLE</b>	DRIVERS CAB OF A UTILITY VEHICLE		
<b>PRIORITY</b>			
<b>PRIORITY NUMBER</b>	<b>DATE</b>	<b>COUNTRY</b>	
001335236	04/07/2012	OHIM	
<b>DESIGN NUMBER</b>	251572		
<b>CLASS</b>	02-04		
<b>1)VIKAS SINGLA, TRADING AS SARA SPORTS PVT. LTD., BASEMENT OF S.C.O NO. 82, SECTOR-38C, CHANDIGARH, INDIA, AN INDIAN NATIONAL</b>			
<b>DATE OF REGISTRATION</b>	11/02/2013		
<b>TITLE</b>	SOLE FOR FOOTWEAR		
<b>PRIORITY NA</b>			
<b>DESIGN NUMBER</b>	248905		
<b>CLASS</b>	08-08		
<b>1)GODREJ &amp; BOYCE MFG. CO. LTD., COMPANY REGISTERED UNDER THE LAWS OF INDIA HAVING ITS PLACE OF BUSINESS AT NO. 1, SIDCO INDUSTRIALESTATE, AMBATTUR, CHENNAI-600098, INDIA</b>			
<b>DATE OF REGISTRATION</b>	19/10/2012		
<b>TITLE</b>	SUPPORTING DEVICE FOR MACHINES		
<b>PRIORITY NA</b>			

<b>DESIGN NUMBER</b>	251281	
<b>CLASS</b>	23-01	
<b>1)TOYOX CO., LTD.</b> 4371, MAEZAWA, KUROBE-SHI, TOYAMA-KEN, JAPAN, A JAPANESE COMPANY		
<b>DATE OF REGISTRATION</b>	29/01/2013	
<b>TITLE</b>	HOSE	
<b>PRIORITY NA</b>		
<b>DESIGN NUMBER</b>	253228	
<b>CLASS</b>	12-16	
<b>1)MINDA INDUSTRIES LIMITED., AN INDIAN COMPANY OF</b> VILL. NAWADA FATEPUR, P.O. SIKANDERPUR BADDA, MANESAR, DISTT. GURGAON, HARYANA-122004, INDIA		
<b>DATE OF REGISTRATION</b>	18/04/2013	
<b>TITLE</b>	MODULAR SWITCH FOR VEHICLE	
<b>PRIORITY NA</b>		
<b>DESIGN NUMBER</b>	254232	
<b>CLASS</b>	12-08	
<b>1)MAHINDRA &amp; MAHINDRA LTD., A COMPANY INCORPORATED</b> <b>UNDER THE INDIAN COMPANIES ACT, 1913 OF</b> GATEWAY BUILDING, APOLLO BUNDER, MUMBAI 400001, MAHARASHTRA, INDIA		
<b>DATE OF REGISTRATION</b>	31/05/2013	
<b>TITLE</b>	CAR	
<b>PRIORITY NA</b>		



<b>DESIGN NUMBER</b>	254705	
<b>CLASS</b>	06-13	
<b>1)SCI EXPORT (P) LTD., SITUATED AT WZ-NA-240, VISHNU GARDEN, NEW DELHI-110018 (INDIA)</b> A COMPANY INCORPORATED UNDER THE INDIAN COMPANIES ACT, OF ABOVE ADDRESS		
<b>DATE OF REGISTRATION</b>	24/06/2013	
<b>TITLE</b>	SOFA BACK COVER	
<b>PRIORITY NA</b>		
<b>DESIGN NUMBER</b>	254763	
<b>CLASS</b>	11-01	
<b>1)H. K JEWELS PVT. LTD. A COMPANY REGISTERED UNDER COMPANY ACT 1956 OF</b> 1701-A, 17TH FLOOR, THE CAPITAL BUILDING, B-WING, OPP ICICI BANK, BANDRA KURLA COMPLEX, BANDRA (E), MUMBAI-400051, INDIA		
<b>DATE OF REGISTRATION</b>	25/06/2013	
<b>TITLE</b>	PENDANT	
<b>PRIORITY NA</b>		
<b>DESIGN NUMBER</b>	250975	
<b>CLASS</b>	09-01	
<b>1)PRAMIT SANGHAVI AND DEWANG SANGHAVI, PARTNERS TRADING AS V2 CORP., A PARTNERSHIP FIRM, INDIAN, MANUFACTURERS AND MERCHANTS, WHOSE ADDRESS IS</b> WZ-8/1, INDUSTRIAL AREA, KIRTI NAGAR, NEW DELHI-110015, INDIA		
<b>DATE OF REGISTRATION</b>	14/01/2013	
<b>TITLE</b>	JAR	
<b>PRIORITY NA</b>		

<b>DESIGN NUMBER</b>	250996	
<b>CLASS</b>	13-01	
<b>1)HONDA MOTOR CO., LTD., A JAPANESE CORPORATION, OF 1-1, MINAMIAOYAMA 2-CHOME, MINATO-KU, TOKYO, JAPAN</b>		
<b>DATE OF REGISTRATION</b>	16/01/2013	
<b>TITLE</b>	CONTROL PANEL COVER FOR ENGINE GENERATOR	
<b>PRIORITY</b>		
<b>PRIORITY NUMBER</b>	<b>DATE</b>	<b>COUNTRY</b>
2012-017122	19/07/2012	JAPAN



<b>DESIGN NUMBER</b>	253943	
<b>CLASS</b>	02-04	
<b>1)GANESH FOOTWEARS, H-44, UDYOG NAGAR, PEERAGARHI, DELHI-110041, INDIA.</b> (AN INDIAN PROPRIETORSHIP FIRM WHOSE PROPRIETOR IS:- SH. GANESH PRASAD AGGARWAL. AN INDIAN NATIONAL OF THE ABOVE ADDRESS		
<b>DATE OF REGISTRATION</b>	17/05/2013	
<b>TITLE</b>	SHOE	
<b>PRIORITY NA</b>		



<b>DESIGN NUMBER</b>	254383	
<b>CLASS</b>	08-06	
<b>1)SHOBHNABEN R BARASIYA (INDIAN NATIONALS) AND SOLE PROPRIETOR OF SURAJ METAL (INDIAN PROPRIETARY CONCERN) HAVING PLACE OF BUSINESS AT-4, PARSANA SOCIETY, NR. 73, SCHOOL RAJKOT- GUJARAT (INDIA)</b>		
<b>DATE OF REGISTRATION</b>	07/06/2013	
<b>TITLE</b>	HANDLE	
<b>PRIORITY NA</b>		

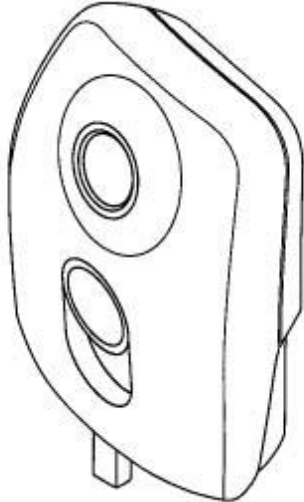
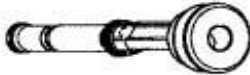
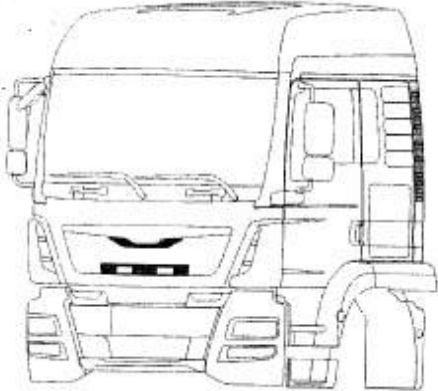

<b>DESIGN NUMBER</b>	237191		
<b>CLASS</b>	09-01		
<b>1)HINDUSTAN UNILEVER LIMITED</b> AT UNILEVER HOUSE, B. D. SAWANT MARG, CHAKALA, ANDHERI (EAST), MUMBAI 400099, STATE OF MAHARASHTRA, INDIA			
<b>DATE OF REGISTRATION</b>	07/06/2011		
<b>TITLE</b>	SPRAY DISPENSER		
<b>PRIORITY</b>			
<b>PRIORITY NUMBER</b>	<b>DATE</b>	<b>COUNTRY</b>	
001249890-0007	14/12/2010	OHIM	
<b>DESIGN NUMBER</b>	248310		
<b>CLASS</b>	15-03		
<b>1)DELAVAL HOLDING AB;</b> OF GUSTAF DE LAVALS VÄG 15, SE-147, TUMBA, SWEDEN			
<b>DATE OF REGISTRATION</b>	01/10/2012		
<b>TITLE</b>	TEATCUP FOR MILKING MACHINE		
<b>PRIORITY NA</b>			
<b>DESIGN NUMBER</b>	250617		
<b>CLASS</b>	12-08		
<b>1)MAN TRUCK &amp; BUS AG, A GERMAN COMPANY OF</b> DACHAUER STR. 667, 80995 MÜNICH, GERMANY			
<b>DATE OF REGISTRATION</b>	03/01/2013		
<b>TITLE</b>	DRIVERS CAB OF A UTILITY VEHICLE		
<b>PRIORITY</b>			
<b>PRIORITY NUMBER</b>	<b>DATE</b>	<b>COUNTRY</b>	
001335236	04/07/2012	OHIM	

<b>DESIGN NUMBER</b>	251264	
<b>CLASS</b>	12-16	
<b>1)DR. ING. H.C.F. PORSCHE AKTIENGESELLSCHAFT, A GERMAN COMPANY OF PORSCHEPLATZ 1, 70435 STUTTGART, GERMANY</b>		
<b>DATE OF REGISTRATION</b>	29/01/2013	
<b>TITLE</b>	CENTRE CONSOLES FOR VEHICLES	
<b>PRIORITY</b>		
<b>PRIORITY NUMBER</b>	<b>DATE</b>	<b>COUNTRY</b>
DE402012100636.3	09/08/2012	GERMANY



<b>DESIGN NUMBER</b>	251471	
<b>CLASS</b>	12-11	
<b>1)HONDA MOTOR CO., LTD., A JAPANESE CORPORATION, OF 1-1, MINAMI-AOYAMA 2-CHOME, MINATO-KU, TOKYO, JAPAN</b>		
<b>DATE OF REGISTRATION</b>	07/02/2013	
<b>TITLE</b>	MOTOR SCOOTER	
<b>PRIORITY</b>		
<b>PRIORITY NUMBER</b>	<b>DATE</b>	<b>COUNTRY</b>
2012-019517	13/08/2012	JAPAN



<b>DESIGN NUMBER</b>	253226	
<b>CLASS</b>	12-16	
<b>1)MINDA INDUSTRIES LIMITED., AN INDIAN COMPANY OF VILL. NAWADA FATEPUR, P.O. SIKANDERPUR BADDA, MANESAR, DISTT. GURGAON, HARYANA-122004, INDIA</b>		
<b>DATE OF REGISTRATION</b>	18/04/2013	
<b>TITLE</b>	MODULAR SWITCH FOR VEHICLE	
<b>PRIORITY NA</b>		



<b>DESIGN NUMBER</b>	253349		
<b>CLASS</b>	14-03		
<b>1)VERTU CORPORATION LIMITED, A COMPANY ORGANIZED AND EXISTING UNDER THE LAWS OF UNITED KINGDOM, OF THE ADDRESS BEACON HILL ROAD, CHURCH CROOKHAM, HAMPSHIRE GU52 8DY, UNITED KINGDOM</b>			
<b>DATE OF REGISTRATION</b>	23/04/2013		
<b>TITLE</b>	MOBILE PHONE		
<b>PRIORITY</b>			
<b>PRIORITY NUMBER</b>	<b>DATE</b>	<b>COUNTRY</b>	
002203075-0001	15/03/2013	OHIM	
<b>DESIGN NUMBER</b>	254080		
<b>CLASS</b>	13-99		
<b>1)INDER INDUSTRIES, A PARTNERSHIP FIRM, CONSTITUTED BY AND BETWEEN MR. DEVNDRA KUMAR JAIN AND ORCHID VINIMAY PVT. LTD., HAVING ADDRESS 301, SOBHNA APARTMENT, CHANDAWARKAR LANE, BORIVALI (W), MUMBAI-400092</b>			
<b>DATE OF REGISTRATION</b>	24/05/2013		
<b>TITLE</b>	BATTEN HOLDER		
<b>PRIORITY NA</b>			
<b>DESIGN NUMBER</b>	254702		
<b>CLASS</b>	06-13		
<b>1)SCI EXPORT (P) LTD., SITUATED AT WZ-NA-240, VISHNU GARDEN, NEW DELHI-110018 (INDIA) A COMPANY INCORPORATED UNDER THE INDIAN COMPANIES ACT, OF ABOVE ADDRESS</b>			
<b>DATE OF REGISTRATION</b>	24/06/2013		
<b>TITLE</b>	SOFA BACK COVER		
<b>PRIORITY NA</b>			

<b>DESIGN NUMBER</b>	254758	
<b>CLASS</b>	11-01	
<b>1)H. K JEWELS PVT. LTD. A COMPANY REGISTERED UNDER COMPANY ACT 1956 OF</b> 1701-A, 17TH FLOOR, THE CAPITAL BUILDING, B-WING, OPP ICICI BANK, BANDRA KURLA COMPLEX, BANDRA (E), MUMBAI-400051, INDIA		
<b>DATE OF REGISTRATION</b>	25/06/2013	
<b>TITLE</b>	RING	
<b>PRIORITY NA</b>		

<b>DESIGN NUMBER</b>	248598	
<b>CLASS</b>	13-02	
<b>1)P4P HOLDINGS, LLC, A COLORADO LIMITED LIABILITY COMPANY HAVING A PLACE OF BUSINESS</b> AT 417-A, MAIN STREET, SUITE A, CARBONDALE, COLORADO 81623, UNITED STATES OF AMERICA		
<b>DATE OF REGISTRATION</b>	12/10/2012	
<b>TITLE</b>	SOLAR ARRAY FOR ENERGY GENERATION	
<b>PRIORITY NA</b>		

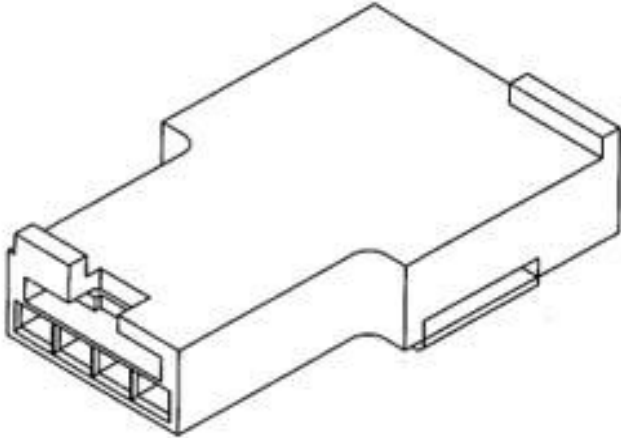
<b>DESIGN NUMBER</b>	250972	
<b>CLASS</b>	13-03	
<b>1)YAZAKI CORPORATION, A JAPANESE CORPORATION OF</b> 4-28, MITA 1-CHOME, MINATO-KU, TOKYO, JAPAN		
<b>DATE OF REGISTRATION</b>	14/01/2013	
<b>TITLE</b>	ELECTRICAL JOINT CONNECTOR	
<b>PRIORITY</b>		
<b>PRIORITY NUMBER</b>	<b>DATE</b>	<b>COUNTRY</b>
2012-017084	18/07/2012	JAPAN

<b>DESIGN NUMBER</b>	250990	
<b>CLASS</b>	23-04	
<b>1)EVEREADY INDUSTRIES INDIA LTD.</b> 1, MIDDLETON STREET, KOLKATA - 700071, WEST BENGAL, INDIA, AN INDIAN COMPANY		
<b>DATE OF REGISTRATION</b>	15/01/2013	
<b>TITLE</b>	FAN	
<b>PRIORITY NA</b>		
<b>DESIGN NUMBER</b>	252089	
<b>CLASS</b>	28-02	
<b>1)DINESH BASTIMAL JAIN (AN INDIAN NATIONAL) AT</b> 203/204 RAJ MADHUR CHS. DEVIDAS LANE, NR. CLUB AQUERIA, BORIVALI (WEST) MUMBAI 400103, STATE OF MAHARASHTRA, INDIA		
<b>DATE OF REGISTRATION</b>	05/03/2013	
<b>TITLE</b>	BOTTLE FOR NAIL POLISH	
<b>PRIORITY NA</b>		
<b>DESIGN NUMBER</b>	253918	
<b>CLASS</b>	23-02	
<b>1)HALLMARK CREATIONS PRIVATE LIMITED (A COMPANY INCORPORATED UNDER THE COMPANIES ACT, 1956) HAVING ITS PRINCIPAL PLACE OF BUSINESS AT</b> PLOT NO. 7/8, SURVEY NO. 20, EVEREST INDUSTRIAL AREA, NEAR PERFECT (TATA) SHOWROOM, NATIONAL HIGHWAY NO. 8, VAVDI-DIST. RAJKOT-360001, GUJARAT-INDIA		
<b>DATE OF REGISTRATION</b>	17/05/2013	
<b>TITLE</b>	TUMBLER HOLDER	
<b>PRIORITY NA</b>		

<b>DESIGN NUMBER</b>	254033	
<b>CLASS</b>	12-08	
<b>1)BAYERISCHE MOTOREN WERKE AKTIENGESELLSCHAFT, OF</b> PETUELRING 130, 80809, MUNICH, GERMANY, A GERMAN COMPANY		
<b>DATE OF REGISTRATION</b>	22/05/2013	
<b>TITLE</b>	CAR	
<b>PRIORITY</b>		
<b>PRIORITY NUMBER</b>	<b>DATE</b>	<b>COUNTRY</b>
DE 402013100192.5	04/03/2013	GERMANY



<b>DESIGN NUMBER</b>	254406	
<b>CLASS</b>	02-04	
<b>1)XO FOOTWEAR PVT. LTD., A-122, MANGOLPURI INDL. AREA, PHASE-2, NEW DELHI-110034, INDIA</b> (AN INDIAN COMPANY DULY REGISTERED UNDER THE COMPANIES ACT, 1956)		
<b>DATE OF REGISTRATION</b>	10/06/2013	
<b>TITLE</b>	SHOE	
<b>PRIORITY NA</b>		



<b>DESIGN NUMBER</b>	254542	
<b>CLASS</b>	11-01	
<b>1)H. K JEWELS PVT. LTD. A COMPANY REGISTERED UNDER COMPANY ACT 1956 OF</b> 1701-A, 17TH FLOOR, THE CAPITAL BUILDING, B-WING, OPP ICICI BANK, BANDRA KURLA COMPLEX, BANDRA (E), MUMBAI-400051, INDIA		
<b>DATE OF REGISTRATION</b>	18/06/2013	
<b>TITLE</b>	NECKLACE	
<b>PRIORITY NA</b>		





<b>DESIGN NUMBER</b>	254566	
<b>CLASS</b>	11-01	
<b>1)H. K JEWELS PVT. LTD. A COMPANY REGISTERED UNDER COMPANY ACT 1956 OF</b> 1701-A, 17TH FLOOR, THE CAPITAL BUILDING, B-WING, OPP ICICI BANK, BANDRA KURLA COMPLEX, BANDRA (E), MUMBAI-400051, INDIA		
<b>DATE OF REGISTRATION</b>	19/06/2013	
<b>TITLE</b>	RING	
<b>PRIORITY NA</b>		