

## ***CONTINUED FROM PART- 1***

### **INTRODUCTION**

In view of the recent amendment made in the Designs (Amendment) Rules, 2008 with effect from 17/06/2008, Publication of the matter relating to Designs is being published in the Official Journal of The Patent Office. This Journal is being published on weekly basis on every Friday covering the various proceedings on Designs as required according to the provisions of under Rule 22, 25, 27 and 39 of the Design (Amendment) Rules, 2008. All the enquiries on this Official Journal and other information as required by the public should be addressed to the Controller General of Patents, Designs & Trade Marks. Suggestions and comments are requested from all quarters so that the content can be enriched.

**DESIGN ACT 2000**  
**(Under Section 31)**  
**RECTIFICATION OF REGISTER**

**Funtastic Limited, a company organized and existing under the laws of Australia, Australia has filed an application on Form-17 through their agent S. Jayaram of Lakshmikumaran & Sridharan, New Delhi, on 03/05/2013 for the rectification of priority date of the application in the Register of Designs is as follows:-**

<b>Design No.</b>	<b>Entered Priority Date</b>	<b>Changed to</b>
230601	01/03/2010	01/02/2010

**Notice of opposition to the Rectification of Register of Designs may be given as per Rule 40 of the Designs Rules, 2001 as amended Design (amendment) Rules, 2008.**

## COPYRIGHT PUBLICATION

<b>SL NO</b>	<b>CASE NUMBERS</b>	<b>RENEWED ON</b>
1.	177572	12.11.2013 (As of 25.09.2013)
2.	177573	12.11.2013 (As of 25.09.2013)
3.	177589	12.11.2013 (As of 25.09.2013)
4.	225495	31.10.2013
5.	225598	31.10.2013
6.	240312	31.10.2013
7.	240946	31.10.2013
8.	242486	31.10.2013
9.	243628	31.10.2013
10.	245902	31.10.2013
11.	187320	18.11.2013
12.	236877	18.11.2013
13.	234104	18.11.2013
14.	186034	18.11.2013
15.	187699	12.11.2013
16.	187354	12.11.2013
17.	187353	12.11.2013
18.	191070	13.11.2013
19.	187035	12.11.2013
20.	187222	12.11.2013
21.	187223	12.11.2013
22.	187364	12.11.2013
23.	187363	12.11.2013
24.	188150	12.11.2013
25.	188905	12.11.2013
26.	188605	12.11.2013
27.	191069	13.11.2013

**RESTORATION OF LAPSED DESIGNS  
UNDER SECTION 12 (2) OF THE DESIGNS ACT, 2000**

**(01)**

An application made under Section 12 (2) of the Designs act, 2000 on **29.08.2013**, for Restoration of **Design No.177572 dated 25.09.1998** in the name of **RAVISSANT PVT. LTD., 50-51, COMMERCIAL COMPLEX, NEW FRIENDS COLONY, NEW DELHI-110065, AN INDIAN COMPANY** has been allowed.

**(02)**

An application made under Section 12 (2) of the Designs act, 2000 on **29.08.2013**, for Restoration of **Design No.177573 dated 25.09.1998** in the name of **RAVISSANT PVT. LTD., 50-51, COMMERCIAL COMPLEX, NEW FRIENDS COLONY, NEW DELHI-110065, AN INDIAN COMPANY** has been allowed.

**(03)**

An application made under Section 12 (2) of the Designs act, 2000 on **29.08.2013**, for Restoration of **Design No.177589 dated 25.09.1998** in the name of **RAVISSANT PVT. LTD., 50-51, COMMERCIAL COMPLEX, NEW FRIENDS COLONY, NEW DELHI-110065, AN INDIAN COMPANY** has been allowed.

**THE DESIGNS ACT 2000**  
**SECTION 30**  
**DESIGN ASSIGNMENT**

The Design stands in the name of **LOCTITE (R & D) LIMITED** registered under the Designs Act, 2000 has been assigned in the Register of Designs in the name as follows:-

<b>Design No.</b>	<b>Class</b>	<b>Name</b>
202241, 202242, 202243, 202244	09-07 (202241) 09-01 (202242, 202243, 202244)	<b>HENKEL IRELAND LIMITED, OF ALFRED- NOBEL-STRABE 10 40789 MONHEIM GERMANY, AN IRISH COMPANY</b>

## REGISTRATION OF DESIGNS

The following designs have been registered. They are now open for public inspection. In the following each entry the Date of Registration is shown. The Priority Number, Priority Date and Priority Country are also shown

<b>DESIGN NUMBER</b>	251171		
<b>CLASS</b>	08-08		
<b>1)DAMJIBHAI LAXMANBHAI SORATHIYA (INDIAN NATIONAL) SOLE PROPRIETOR OF NEW RAMESHWAR ENTERPRISE HAVING PLACE OF BUSINESS</b> AT -7, PATEL NAGAR, 80 FEET ROAD, RAJKOT-360002-GUJARAT (INDIA)			
<b>DATE OF REGISTRATION</b>	24/01/2013		
<b>TITLE</b>	CURTAIN ROD BRACKET STAND		
<b>PRIORITY NA</b>			
<b>DESIGN NUMBER</b>	252761		
<b>CLASS</b>	13-02		
<b>1)LUMINOUS POWER TECHNOLOGIES PVT. LTD.,</b> PLOT-300, 2ND FLOOR, UDYOG VIHAR, PHASE-II, GURGAON, HARYANA-122016 (INDIA) AN INDIAN COMPANY			
<b>DATE OF REGISTRATION</b>	02/04/2013		
<b>TITLE</b>	INVERTER WITH LAMP HOLDER		
<b>PRIORITY NA</b>			
<b>DESIGN NUMBER</b>	252897		
<b>CLASS</b>	12-16		
<b>1)SCANIA CV AB,</b> SE-151 87, SÖDERTÄLJE, SWEDEN			
<b>DATE OF REGISTRATION</b>	04/04/2013		
<b>TITLE</b>	CAB CORNER		
<b>PRIORITY</b>			
<b>PRIORITY NUMBER</b>	<b>DATE</b>	<b>COUNTRY</b>	
2012/0446	10/10/2012	SWEDEN	

<b>DESIGN NUMBER</b>	251483
<b>CLASS</b>	15-99
<b>1)KLAD ON DESIGN PVT LTD, HAVING PLACE OF BUSINESS AT- #5&amp;6, SURVEY NO 38/2, NADAKERAPPA INDUSTRIAL ESTATE, ANDRAHALLI MAIN ROAD, NEAR PEENYA 2ND STAGE, BANGALORE- 560091</b>	
<b>DATE OF REGISTRATION</b>	07/02/2013
<b>TITLE</b>	MACHINE ENCLOSURE FOR BROACHING MACHINE
<b>PRIORITY NA</b>	

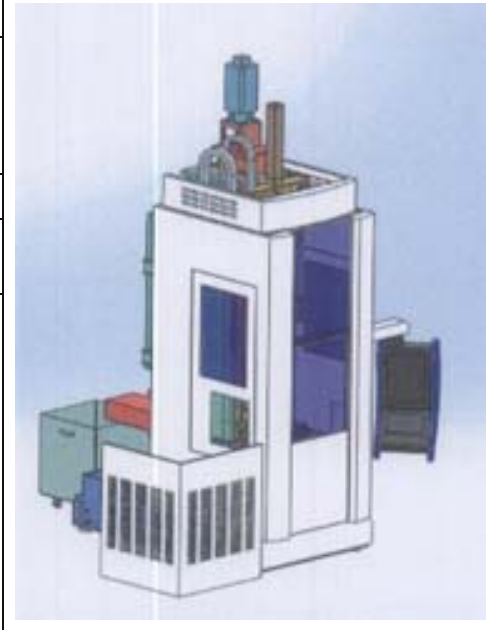



<b>DESIGN NUMBER</b>	253508
<b>CLASS</b>	12-11
<b>1)SANYANG INDUSTRY CO., LTD., A COMPANY ORGANIZED AND EXISTING UNDER THE LAWS OF TAIWAN, REPUBLIC OF CHINA WHO ARE TAIWANESE BY NATIONALITY AND WHOSE ADDRESS IS NO. 184, KENG TZU KOU, SHANG KENG VILLAGE, HSIN FONG SHIANG, HSINCHU, COUNTY 304, TAIWAN, REPUBLIC OF CHINA</b>	
<b>DATE OF REGISTRATION</b>	29/04/2013
<b>TITLE</b>	MOTOR SCOOTER
<b>PRIORITY NA</b>	



<b>DESIGN NUMBER</b>	250609	
<b>CLASS</b>	12-08	
<b>1)MAN TRUCK &amp; BUS AG, A GERMAN COMPANY OF DACHAUER STR. 667, 80995 MÜNICH, GERMANY</b>		
<b>DATE OF REGISTRATION</b>	03/01/2013	
<b>TITLE</b>	DRIVERS CAB OF A UTILITY VEHICLE	
<b>PRIORITY</b>		
<b>PRIORITY NUMBER</b>	<b>DATE</b>	<b>COUNTRY</b>
001335236	04/07/2012	OHIM



<b>DESIGN NUMBER</b>	252083	
<b>CLASS</b>	08-06	
<b>1)NILESH V. SHAH, AN INDIAN NATIONAL, TRADING AS PALLADIUM PRODUCTS, AN INDIAN PROPRIETARY CONCERN OF THE ADDRESS SURVEY NO. 126, JAMNAGAR-KHAMBHALIA HIGHWAY, AT &amp; POST-VASAI 361006 DIST. JAMNAGAR (GUJARAT) INDIA</b>		
<b>DATE OF REGISTRATION</b>	05/03/2013	
<b>TITLE</b>	HANDLE	
<b>PRIORITY NA</b>		
<b>DESIGN NUMBER</b>	252110	
<b>CLASS</b>	28-02	
<b>1)DINESH BASTIMAL JAIN (AN INDIAN NATIONAL) AT 203/204 RAJ MADHUR CHS. DEVIDAS LANE, NR. CLUB AQUERIA, BORIVALI (WEST) MUMBAI 400103, STATE OF MAHARASHTRA, INDIA</b>		
<b>DATE OF REGISTRATION</b>	05/03/2013	
<b>TITLE</b>	BOTTLE FOR NAIL POLISH	
<b>PRIORITY NA</b>		
<b>DESIGN NUMBER</b>	252134	
<b>CLASS</b>	19-06	
<b>1)MURJI PUNJA PATEL, SOLE PROPRIETOR, TRADING AS BOMBAY STATIONERS AT SHOP NO. 1, DOOR NO. 9, HAZARI STREET, MOUNT ROAD, CHENNAI-600002, TAMIL NADU, INDIA, WHICH IS AN INDIAN PROPRIETARY CONCERN OF ABOVE ADDRESS</b>		
<b>DATE OF REGISTRATION</b>	06/03/2013	
<b>TITLE</b>	MARKER PEN	
<b>PRIORITY NA</b>		



<b>DESIGN NUMBER</b>	249613	
<b>CLASS</b>	24-02	
<b>1)BIOMÉRIEUX, INC. OF THE ADDRESS:</b> 595 ANGLUM RD., HAZELWOOD, MISSOURI 63042, UNITED STATES OF AMERICA		
<b>DATE OF REGISTRATION</b>	21/11/2012	
<b>TITLE</b>	BIOCHEMICAL TEST CARD FOR AUTOMATED MICROBIAL TESTING SYSTEM	
<b>PRIORITY</b>		
<b>PRIORITY NUMBER</b>	<b>DATE</b>	<b>COUNTRY</b>
29/422,604	22/05/2012	U.S.A.

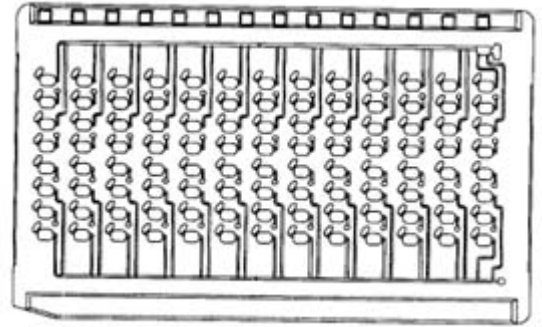

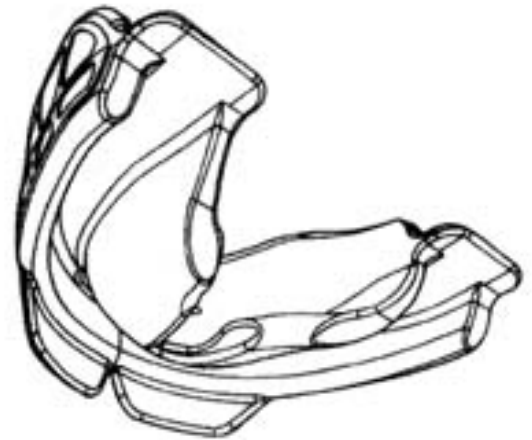

<b>DESIGN NUMBER</b>	251940	
<b>CLASS</b>	24-99	
<b>1)CHRISTOPHER JOHN FARRELL, AUSTRALIAN NATIONAL, OF</b> 44 SIGANTO DRIVE HELENSVALE QLD 4212, AUSTRALIA		
<b>DATE OF REGISTRATION</b>	28/02/2013	
<b>TITLE</b>	ORTHODONTIC APPLIANCE	
<b>PRIORITY</b>		
<b>PRIORITY NUMBER</b>	<b>DATE</b>	<b>COUNTRY</b>
AU 143331/2012	31/08/2012	AUSTRALIA



<b>DESIGN NUMBER</b>	253608	
<b>CLASS</b>	12-16	
<b>1)MINDA INDUSTRIES LIMITED., AN INDIAN COMPANY OF</b> VILL. NAWADA FATEPUR, P.O. SIKANDERPUR BADDA, MANESAR, DISTT. GURGAON, HARYANA-122004, INDIA		
<b>DATE OF REGISTRATION</b>	01/05/2013	
<b>TITLE</b>	CLUTCH PEDAL POSITION SENSOR FOR VEHICLE	
<b>PRIORITY NA</b>		



<b>DESIGN NUMBER</b>	251002	
<b>CLASS</b>	08-07	
<b>1)NARENDRA PAL SINGH (AN INDIAN NATIONAL), TRADING AS M/S. MANAS LOCKS, SAROJ NAGAR, QUARSHI BYE PASS, ETAH CHUNGI, ALIGARH-202001 (U.P.)</b>		
<b>DATE OF REGISTRATION</b>	16/01/2013	
<b>TITLE</b>	LOCK	
<b>PRIORITY NA</b>		
<b>DESIGN NUMBER</b>	253155	
<b>CLASS</b>	09-01	
<b>1)SIVAPRAKASAM RAJASEKARAN AND VARADHARAJAN ARULMANISEKARAN, TRADING IN PARTNERSHIP AS M/S. RENGANAYAKI AGENCY, AT NO. 9/A, MGK COMPLEX, P.K. SALAI, KARAİKAL-609602, PUDUCHERRY, INDIA, WHICH IS AN INDIAN PARTNERSHIP FIRM OF ABOVE ADDRESS</b>		
<b>DATE OF REGISTRATION</b>	15/04/2013	
<b>TITLE</b>	BOTTLE	
<b>PRIORITY NA</b>		
<b>DESIGN NUMBER</b>	253369	
<b>CLASS</b>	23-03	
<b>1)ELICA PB INDIA PRIVATE LIMITED, A COMPANY REGISTERED UNDER THE PROVISION OF INDIAN COMPANIES ACT, 1956, HAVING OFFICE ADDRESS AT 37/1/1, KONDHWA PISOLI ROAD, PISOLI, PUNE-411028, MAHARASHTRA, INDIA</b>		
<b>DATE OF REGISTRATION</b>	23/04/2013	
<b>TITLE</b>	BURNER FOR GAS STOVES	
<b>PRIORITY NA</b>		



<b>DESIGN NUMBER</b>	223242	
<b>CLASS</b>	09-03	
<b>1)KRITI INDUSTRIES (INDIA) LTD.</b> INDUSTERIAL AREA NO. 3, A. B. ROAD, DEWAS-455 001 (M.P) INDIA		
<b>DATE OF REGISTRATION</b>	08/06/2009	
<b>TITLE</b>	CAN	
<b>PRIORITY NA</b>		
<b>DESIGN NUMBER</b>	252067	
<b>CLASS</b>	09-01	
<b>1)M/S. S.G.S. DETERGENTS PVT LTD., (AN INDIAN COMPANY REGISTERED UNDER THE INDIAN COMPANIES ACT, 1956),</b> NO. 95 & 96, RAJIV NAGAR, PALLIKUPPAM, CHENNAI-602102, TAMILNADU, INDIA		
<b>DATE OF REGISTRATION</b>	05/03/2013	
<b>TITLE</b>	BOTTLE	
<b>PRIORITY NA</b>		
<b>DESIGN NUMBER</b>	252098	
<b>CLASS</b>	28-02	
<b>1)DINESH BASTIMAL JAIN (AN INDIAN NATIONAL) AT</b> 203/204 RAJ MADHUR CHS. DEVIDAS LANE, NR. CLUB AQUERIA, BORIVALI (WEST) MUMBAI 400103, STATE OF MAHARASHTRA, INDIA		
<b>DATE OF REGISTRATION</b>	05/03/2013	
<b>TITLE</b>	BOTTLE FOR NAIL POLISH	
<b>PRIORITY NA</b>		

<b>DESIGN NUMBER</b>	252109	
<b>CLASS</b>	28-03	
<b>1)DINESH BASTIMAL JAIN (AN INDIAN NATIONAL) AT</b> 203/204 RAJ MADHUR CHS. DEVIDAS LANE, NR. CLUB AQUERIA, BORIVALI (WEST) MUMBAI 400103, STATE OF MAHARASHTRA, INDIA		
<b>DATE OF REGISTRATION</b>	05/03/2013	
<b>TITLE</b>	PERFUME BOTTLE	
<b>PRIORITY NA</b>		
<b>DESIGN NUMBER</b>	253923	
<b>CLASS</b>	08-08	
<b>1)(1) MEHULBHAI D. CHAVDA (2) SOMESHBHAI S. MALIK AND (3) DHIRENBHAI SHAH ALL INDIAN NATIONAL PARTNER OF DMS ARCHITECTURAL PRODUCTS AN INDIAN PARTNERSHIP FIRM HAVING ITS PRINCIPAL PLACE OF BUSINESS AT ADDRESS:</b> PLOT NO. 6, SURVEY NO. 20, EVEREST INDUSTRIAL AREA, NEAR PERFECT (TATA) SHOWROOM, NATIONAL HIGHWAY NO. 8-B, VAVDI-DIST. RAJKOT-360004, GUJARAT-INDIA		
<b>DATE OF REGISTRATION</b>	17/05/2013	
<b>TITLE</b>	CURTAIN BRACKET	
<b>PRIORITY NA</b>		
<b>DESIGN NUMBER</b>	251733	
<b>CLASS</b>	31-00	
<b>1)BLOW HOT KITCHEN APPLIANCES PRIVATE LIMITED, AN INDIAN COMPANY, INCORPORATED UNDER THE COMPANIES ACT, 1956, HAVING ITS ADDRESS AS</b> B/15, INDUSTRIAL ESTATE, POLO GROUND, INDORE-452015, MADHYA PRADESH, INDIA		
<b>DATE OF REGISTRATION</b>	18/02/2013	
<b>TITLE</b>	INDUCTION COOKER	
<b>PRIORITY NA</b>		

<b>DESIGN NUMBER</b>	251787	
<b>CLASS</b>	02-04	
<b>1)M/S VEEKESY ELASTOMERS PVT LTD, AN INDIAN COMPANY REGISTERED UNDER COMPANIES ACT, 1956, HAVING ITS REGISTERED OFFICE AT</b> DOOR NO. VII/330, NH-17, KOLATHARA P.O, KOZHICODE, PIN-673655, KERALA, INDIA		
<b>DATE OF REGISTRATION</b>	19/02/2013	
<b>TITLE</b>	FOOTWEAR	
<b>PRIORITY NA</b>		

<b>DESIGN NUMBER</b>	253812	
<b>CLASS</b>	08-06	
<b>1)DILIPBHAI BACHUBHAI HIRPARA (INDIAN NATIONALS) AND SOLE PROPRIETOR OF JANKI DIE-CAST (INDIAN PROPRIETORSHIP CONCERN) HAVING PLACE OF BUSINESS</b> AT-PLOT NO. 834, AJI INDUSTRIAL AREA, NR; SITARAM WAY BRIDGE, OPP: MUNICIPAL WORKSHOP, BHAVNAGAR ROAD, RAJKOT-GUJARAT (INDIA)		
<b>DATE OF REGISTRATION</b>	15/05/2013	
<b>TITLE</b>	HANDLE	
<b>PRIORITY NA</b>		

<b>DESIGN NUMBER</b>	250917	
<b>CLASS</b>	12-11	
<b>1)REMSON EXPORTS,</b> 536/21-D-6/2, DHANDARI KALAN, INDUSTRIAL AREA-C, LUDHIANA (PB.) INDIA, AN INDIAN NATIONAL		
<b>DATE OF REGISTRATION</b>	10/01/2013	
<b>TITLE</b>	PADDLE FOR CYCLES	
<b>PRIORITY NA</b>		

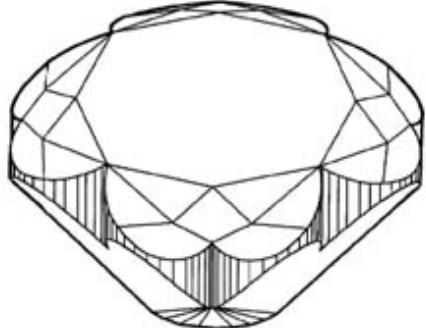
<b>DESIGN NUMBER</b>	251436		
<b>CLASS</b>	21-02		
<b>1)ZEDEL (SOCIÉTÉ PAR ACTIONS SIMPLIFIÉE), A FRENCH COMPANY OF ZONE INDUSTRIELLE DE CROLLES, 38920 CROLLES, FRANCE (FR)</b>			
<b>DATE OF REGISTRATION</b>	05/02/2013		
<b>TITLE</b>	CARABINER		
<b>PRIORITY</b>			
<b>PRIORITY NUMBER</b>	<b>DATE</b>	<b>COUNTRY</b>	
002084566-0002	07/08/2012	OHIM	
<b>DESIGN NUMBER</b>	251463		
<b>CLASS</b>	06-04		
<b>1)WIM PLAST LIMITED, A PUBLIC LIMITED COMPANY REGISTERED UNDER THE PROVISION OF THE INDIAN COMPANIES ACT, 1956, HAVING OFFICE ADDRESS AT 5, VAKIL INDUSTRIAL ESTATE, WALBHAT ROAD, GOREGAON (EAST), MUMBAI-400063, MAHARASHTRA, MUMBAI</b>			
<b>DATE OF REGISTRATION</b>	06/02/2013		
<b>TITLE</b>	CUPBOARD		
<b>PRIORITY NA</b>			
<b>DESIGN NUMBER</b>	252723		
<b>CLASS</b>	11-01		
<b>1)YAIR SHIMANSKY, A NATIONAL OF REPUBLIC OF SOUTH AFRICA, OF 8 LOQUAT, UNIT 2, MORENZON ESTATE, CONSTANTIA, 7806, CAPE TOWN, REPUBLIC OF SOUTH AFRICA</b>			
<b>DATE OF REGISTRATION</b>	01/04/2013		
<b>TITLE</b>	GEMSTONE		
<b>PRIORITY</b>			
<b>PRIORITY NUMBER</b>	<b>DATE</b>	<b>COUNTRY</b>	
A2012/01896	31/10/2012	SOUTH AFRICA	

<b>DESIGN NUMBER</b>	252898	
<b>CLASS</b>	12-16	
1)SCANIA CV AB, SE-151 87, SÖDERTÄLJE, SWEDEN		
<b>DATE OF REGISTRATION</b>	04/04/2013	
<b>TITLE</b>	CAB CORNER	
<b>PRIORITY</b>		
<b>PRIORITY NUMBER</b>	<b>DATE</b>	<b>COUNTRY</b>
2012/0446	10/10/2012	SWEDEN





<b>DESIGN NUMBER</b>	250612	
<b>CLASS</b>	12-08	
1)MAN TRUCK & BUS AG, A GERMAN COMPANY OF DACHAUER STR. 667, 80995 MÜNICH, GERMANY		
<b>DATE OF REGISTRATION</b>	03/01/2013	
<b>TITLE</b>	DRIVERS CAB OF A UTILITY VEHICLE	
<b>PRIORITY</b>		
<b>PRIORITY NUMBER</b>	<b>DATE</b>	<b>COUNTRY</b>
001335236	04/07/2012	OHIM



<b>DESIGN NUMBER</b>	251976	
<b>CLASS</b>	14-02	
1)APPLE INC., 1 INFINITE LOOP, CUPERTINO, CALIFORNIA 95014, UNITED STATES OF AMERICA, A CORPORATION INCORPORATED IN THE STATE OF CALIFORNIA		
<b>DATE OF REGISTRATION</b>	01/03/2013	
<b>TITLE</b>	CONNECTOR FOR ELECTRONIC DEVICE	
<b>PRIORITY</b>		
<b>PRIORITY NUMBER</b>	<b>DATE</b>	<b>COUNTRY</b>
29/431,556	07/09/2012	U.S.A.

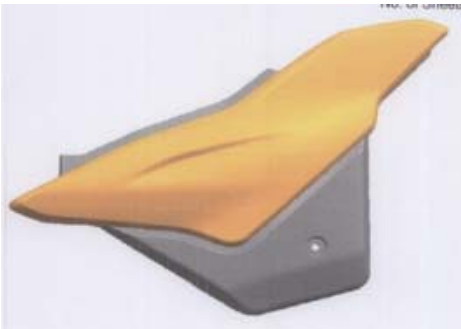

<b>DESIGN NUMBER</b>	251992	
<b>CLASS</b>	12-11	
<b>1)BAJAJ AUTO LIMITED, AN INDIAN COMPANY, INCORPORATED UNDER THE COMPANIES ACT OF 1956, HAVING ITS PRINCIPAL PLACE OF BUSINESS AT NEW 2ND &amp; 3RD FLOOR, KHIVRAJ BUILDING, NO. 616, ANNASALAI, CHENNAI - 600006, STATE OF TAMIL NADU, INDIA, AND REGISTERED OFFICE AT AKURDI, PUNE-411035, STATE OF MAHARASHTRA, INDIA</b>		
<b>DATE OF REGISTRATION</b>	01/03/2013	
<b>TITLE</b>	SIDE COVER FOR VEHICLE	
<b>PRIORITY NA</b>		

<b>DESIGN NUMBER</b>	252101	
<b>CLASS</b>	28-02	
<b>1)DINESH BASTIMAL JAIN (AN INDIAN NATIONAL) AT 203/204 RAJ MADHUR CHS. DEVIDAS LANE, NR. CLUB AQUERIA, BORIVALI (WEST) MUMBAI 400103, STATE OF MAHARASHTRA, INDIA</b>		
<b>DATE OF REGISTRATION</b>	05/03/2013	
<b>TITLE</b>	BOTTLE FOR NAIL POLISH	
<b>PRIORITY NA</b>		

<b>DESIGN NUMBER</b>	252195	
<b>CLASS</b>	14-03	
<b>1)APPLE INC., 1 INFINITE LOOP, CUPERTINO, CALIFORNIA 95014, UNITED STATES OF AMERICA, A CORPORATION INCORPORATED IN THE STATE OF CALIFORNIA</b>		
<b>DATE OF REGISTRATION</b>	07/03/2013	
<b>TITLE</b>	CONTROLLER FOR ELECTRONIC DEVICE	
<b>PRIORITY</b>		
<b>PRIORITY NUMBER</b>	<b>DATE</b>	<b>COUNTRY</b>
29/431,844	11/09/2012	U.S.A.



<b>DESIGN NUMBER</b>	251623	
<b>CLASS</b>	15-03	
<b>1)KANAV AGRO INDUSTRIES PVT. LTD., SINGLE CYCLE ROAD, DHANDARI KALAN, INDUSTRIAL AREA-C, LUDHIANA-141 010 (PUNJAB) INDIA</b> (AN INDIAN COMPANY DULY REGISTERED UNDER THE COMPANIES ACT, 1956) OF THE ABOVE ADDRESS		
<b>DATE OF REGISTRATION</b>	14/02/2013	
<b>TITLE</b>	BLADE FOR USE IN CROP CUTTING MACHINE	
<b>PRIORITY NA</b>		
<b>DESIGN NUMBER</b>	253412	
<b>CLASS</b>	21-02	
<b>1)GRAND SLAM FITNESS PVT. LTD., E-540, GREATER KAILASH-II, NEW DELHI-110048, INDIA,</b> AN INDIAN COMPANY REGISTERED UNDER THE PROVISIONS OF INDIAN COMPANIES ACT, 1956, OF THE ABOVE ADDRESS		
<b>DATE OF REGISTRATION</b>	25/04/2013	
<b>TITLE</b>	EXERCISE APPARATUS	
<b>PRIORITY NA</b>		
<b>DESIGN NUMBER</b>	253492	
<b>CLASS</b>	02-02	
<b>1)KEWAL KIRAN CLOTHING LTD. OF</b> KEWAL KIRAN ESTATE, 460/7 I.B.PATEL ROAD, NEAR TIRUPATI UDYOG, GOREGAON (EAST), MUMBAI-400063, MAHARASHTRA, INDIA, INDIAN COMPANY		
<b>DATE OF REGISTRATION</b>	29/04/2013	
<b>TITLE</b>	T-SHIRT WITH EARPHONE	
<b>PRIORITY NA</b>		

<b>DESIGN NUMBER</b>	253517			
<b>CLASS</b>	13-03			
<b>1)GOLD MEDAL ELECTRICALS PVT. LTD. A COMPANY REGISTERED UNDER COMPANY ACT 1956 WHOSE ADDRESS IS, A/302, KEMP PLAZA, MIND SPACE, OFF LINK ROAD, CHINCHOLI BUNDER, MALAD (WEST), MUMBAI-400064, MAHARASHTRA, INDIA</b>				
<b>DATE OF REGISTRATION</b>	30/04/2013			
<b>TITLE</b>	SWITCH COVER PLATE			
<b>PRIORITY NA</b>				
<b>DESIGN NUMBER</b>	251738			
<b>CLASS</b>	13-03			
<b>1)SIEMENS AKTIENGESELLSCHAFT, OF WITTELSBACHERPLATZ 2, 80333 MUNCHEN, GERMANY, A GERMAN COMPANY</b>				
<b>DATE OF REGISTRATION</b>	18/02/2013			
<b>TITLE</b>	SAFETY RELAY			
<b>PRIORITY</b>				
<b>PRIORITY NUMBER</b>	<b>DATE</b>	<b>COUNTRY</b>		
001340897	24/08/2012	OHIM		
<b>DESIGN NUMBER</b>	251809			
<b>CLASS</b>	06-01			
<b>1)HOF FURNITURE SYSTEM PVT. LTD., A COMPANY INCORPORATED UNDER THE INDIAN COMPANIES ACT, HAVING ITS ADDRESS AT, STEEL TOWN OWNER ASSOCIATIONS, PLOT NO. C-1, SURVEY NO. 429, POST: MORAIYA, TA: SANAND, DIST: AHMEDABAD, GUJARAT STATE, INDIA</b>				
<b>DATE OF REGISTRATION</b>	21/02/2013			
<b>TITLE</b>	CHAIR			
<b>PRIORITY NA</b>				

<b>DESIGN NUMBER</b>	251005	
<b>CLASS</b>	24-01	
<b>1)GENERAL ELECTRIC COMPANY, A NEW YORK CORPORATION INCORPORATED UNDER THE LAWS OF UNITED STATES OF AMERICA HAVING ITS OFFICE AT</b> 1 RIVER ROAD, SCHENECTADY, NEW YORK 12345 UNITED STATES OF AMERICA		
<b>DATE OF REGISTRATION</b>	17/01/2013	
<b>TITLE</b>	COMPUTED TOMOGRAPHY IMAGING SYSTEM GANTRY	
<b>PRIORITY NA</b>		
<b>DESIGN NUMBER</b>	252908	
<b>CLASS</b>	12-15	
<b>1)CONTINENTAL REIFEN DEUTSCHLAND GMBH,</b> VAHRENWALDER STR. 9, 30165 HANNOVER, GERMANY		
<b>DATE OF REGISTRATION</b>	05/04/2013	
<b>TITLE</b>	TYRE	
<b>PRIORITY</b>		
<b>PRIORITY NUMBER</b>	<b>DATE</b>	<b>COUNTRY</b>
002122077-0001	19/10/2012	OHIM
<b>DESIGN NUMBER</b>	253377	
<b>CLASS</b>	09-02	
<b>1)PRABH DAYAL OM PARKASH INFRASTRUCTURE PVT. LTD., AN INDIAN COMPANY DULY INCORPORATED UNDER THE COMPANIES ACT, 1956, WITH LIMITED LIABILITY, HAVING ITS REGISTERED OFFICE AT</b> 2880, SIRKIWALAN, HAUZ QAZI, DELHI-110006, INDIA		
<b>DATE OF REGISTRATION</b>	25/04/2013	
<b>TITLE</b>	WATER STORAGE TANK	
<b>PRIORITY NA</b>		

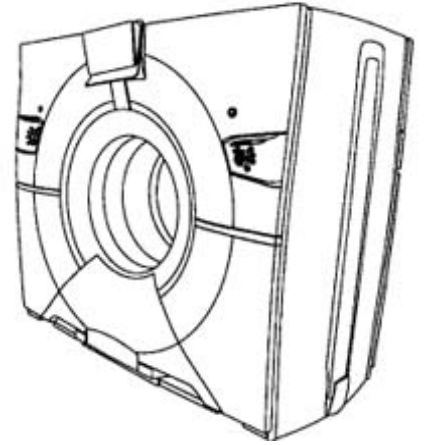

<b>DESIGN NUMBER</b>	252651
<b>CLASS</b>	19-02
<b>1)LA-PAR CREATIONS., (A PARTNERSHIP FIRM REGISTERED UNDER INDIAN PARTNERSHIP ACT, 1932), AT C-1/C-2, SHREYAS INDUSTRIAL ESTATE, OFF. W. E. HIGHWAY (BEHIND JAY COACH), GOREGAON (EAST), MUMBAI-400063. MAHARASHTRA, INDIA. WHOSE PARTNERS ARE (1) RAKESH JAIN. (INDIAN NATIONAL), (2) ANITA JAIN. (INDIAN NATIONAL), &amp; (3) INDU JAIN. (INDIAN NATIONAL), ALL ARE HAVING ABOVE ADDRESS</b>	
<b>DATE OF REGISTRATION</b>	25/03/2013
<b>TITLE</b>	CUTTING DEVICES ADHESIVE TAPES
<b>PRIORITY NA</b>	



<b>DESIGN NUMBER</b>	252734
<b>CLASS</b>	09-01
<b>1)MR. SACHIN SACHDEV MRS. MANASI SACHDEV AND MR. RAVI CHAWLA ALL PARTNERS OF NAYASA MULTIPLAST BEING A PARTNERSHIP CONCERN DULY REGISTERED UNDER THE PARTNERSHIP ACT, 1932 HAVING ITS ADDRESS AT</b> PLOT NOS. 224, 225, 227 AND 228, VILLAGE VELA BATHRI, TAHASIL HAROLI, DISTRICT UNA-732141, HIMACHAL PRADESH	
<b>DATE OF REGISTRATION</b>	01/04/2013
<b>TITLE</b>	WATER BOTTLE



<b>PRIORITY NA</b>	
--------------------	--

<b>DESIGN NUMBER</b>	252899	
<b>CLASS</b>	12-16	
<b>1)SCANIA CV AB, SE-151 87, SÖDERTÄLJE, SWEDEN</b>		
<b>DATE OF REGISTRATION</b>	04/04/2013	
<b>TITLE</b>	FLASHER CASING	
<b>PRIORITY</b>		
<b>PRIORITY NUMBER</b>	<b>DATE</b>	<b>COUNTRY</b>
2012/0448	11/10/2012	SWEDEN

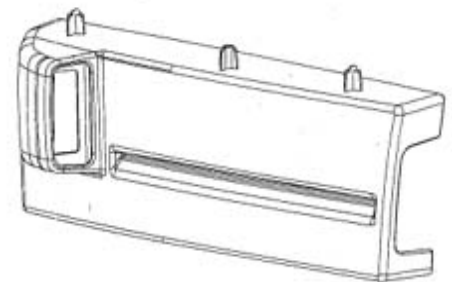

<b>DESIGN NUMBER</b>	248207	
<b>CLASS</b>	23-01	
<b>1)MASCO CORPORATION OF INDIANA, AN INDIANA CORPORATION, OF THE ADDRESS</b>	55 EAST 111TH STREET, INDIANAPOLIS, INDIANA 46280	
<b>DATE OF REGISTRATION</b>	26/09/2012	
<b>TITLE</b>	FAUCET	
<b>PRIORITY</b>		
<b>PRIORITY NUMBER</b>	<b>DATE</b>	<b>COUNTRY</b>
29/418,077	12/04/2012	U.S.A.

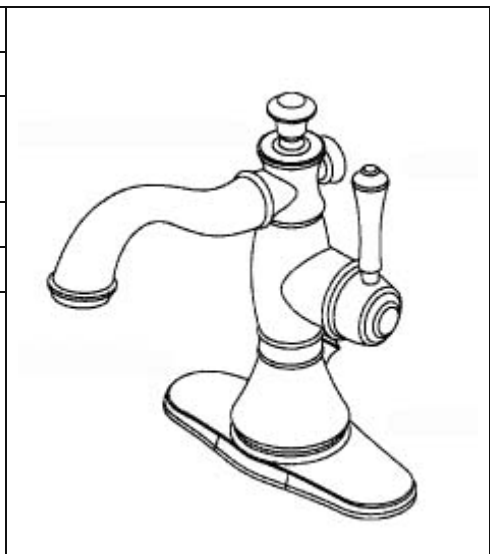

<b>DESIGN NUMBER</b>	250615	
<b>CLASS</b>	12-08	
<b>1)MAN TRUCK &amp; BUS AG, A GERMAN COMPANY OF DACHAUER STR. 667, 80995 MÜNICH, GERMANY</b>		
<b>DATE OF REGISTRATION</b>	03/01/2013	
<b>TITLE</b>	DRIVERS CAB OF A UTILITY VEHICLE	
<b>PRIORITY</b>		
<b>PRIORITY NUMBER</b>	<b>DATE</b>	<b>COUNTRY</b>
001335236	04/07/2012	OHIM

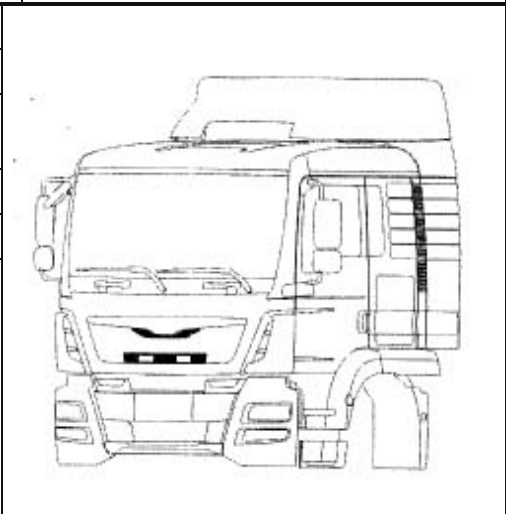

<b>DESIGN NUMBER</b>	252103	
<b>CLASS</b>	28-02	
<b>1)DINESH BASTIMAL JAIN (AN INDIAN NATIONAL) AT 203/204 RAJ MADHUR CHS. DEVIDAS LANE, NR. CLUB AQUERIA, BORIVALI (WEST) MUMBAI 400103, STATE OF MAHARASHTRA, INDIA</b>		
<b>DATE OF REGISTRATION</b>	05/03/2013	
<b>TITLE</b>	BOTTLE FOR NAIL POLISH	
<b>PRIORITY NA</b>		



<b>DESIGN NUMBER</b>	251486
<b>CLASS</b>	15-99
<b>1)KLAD ON DESIGN PVT LTD, HAVING PLACE OF BUSINESS AT- #5&amp;6, SURVEY NO 38/2, NADAKERAPPA INDUSTRIAL ESTATE, ANDRAHALLI MAIN ROAD, NEAR PEENYA 2ND STAGE, BANGALORE- 560091</b>	
<b>DATE OF REGISTRATION</b>	07/02/2013
<b>TITLE</b>	MACHINE ENCLOSURE FOR DEEP HOLE DRILLING MACHINE
<b>PRIORITY NA</b>	

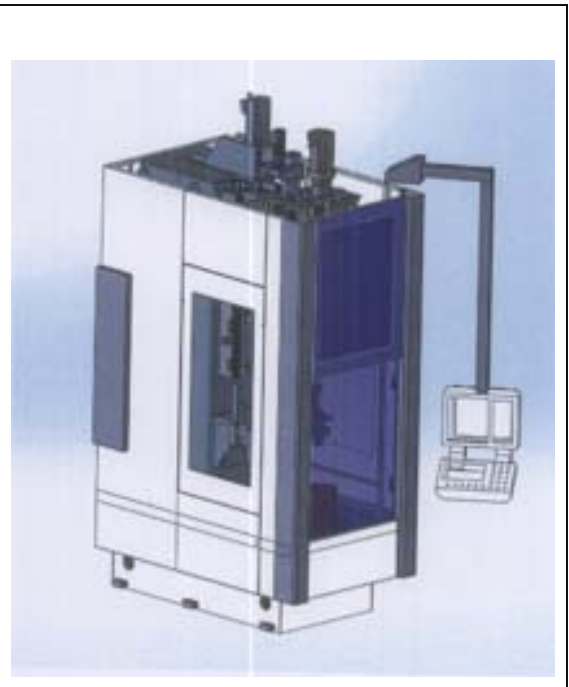



<b>DESIGN NUMBER</b>	251599	
<b>CLASS</b>	24-02	
<b>1)EPPENDORF AG, ADDRESS AT BARKHAUSENWEG 1, 22339 HAMBURG, GERMANY, A GERMAN COMPANY</b>		
<b>DATE OF REGISTRATION</b>	13/02/2013	
<b>TITLE</b>	THERMOMIXER	
<b>PRIORITY</b>		
<b>PRIORITY NUMBER</b>	<b>DATE</b>	<b>COUNTRY</b>
40 2012 003 937.3	27/08/2012	GERMANY



<b>DESIGN NUMBER</b>	253519	
<b>CLASS</b>	13-03	
<b>1)GOLD MEDAL ELECTRICALS PVT. LTD. A COMPANY REGISTERED UNDER COMPANY ACT 1956 WHOSE ADDRESS IS, A/302, KEMP PLAZA, MIND SPACE, OFF LINK ROAD, CHINCHOLI BUNDER, MALAD (WEST), MUMBAI-400064, MAHARASHTRA, INDIA</b>		
<b>DATE OF REGISTRATION</b>	30/04/2013	
<b>TITLE</b>	SWITCH COVER PLATE	
<b>PRIORITY NA</b>		

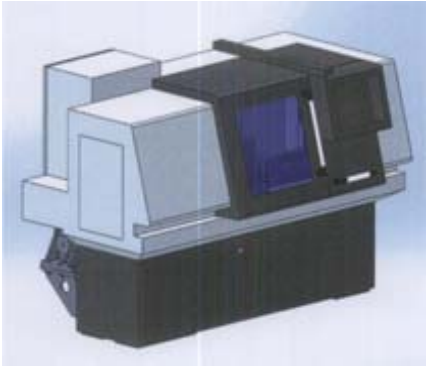

<b>DESIGN NUMBER</b>	252378	
<b>CLASS</b>	25-01	
<b>1)VIRAL KUMAR SHETH AND SANJAY KUMAR SHETH, PARTNERS OF M/S. SADHAN ENTERPRISE, HAVING ITS OFFICE AT SITARAMPUR STATION ROAD, P.O.-SITARAMPUR-713359, DIST-BURDWAN (W.B), AN INDIAN, OF THE ABOVE ADDRESS</b>		
<b>DATE OF REGISTRATION</b>	18/03/2013	
<b>TITLE</b>	SLEEPER FOR RAIL LINE USED IN UNDER GROUND MINE CAR	
<b>PRIORITY NA</b>		
<b>DESIGN NUMBER</b>	253185	
<b>CLASS</b>	25-01	
<b>1)RAHUL JINDAL (DIRECTOR) &amp; KIRAN JAIN (DIRECTOR), INDIAN (NATIONALITY), TRADING AS LOOM CRAFTS FURNITURE (INDIA) PVT. LTD. (THIS COMPANY IS REGISTERED UNDER INDIAN COMPANIES ACT-1956) WHOSE ADDRESS IS A-7/98 &amp; 99, SOUTH SIDE OF G. T. ROAD, INDUSTRIAL AREA, GHAZIABAD-201009 (U.P.) (INDIA)</b>		
<b>DATE OF REGISTRATION</b>	16/04/2013	
<b>TITLE</b>	CLADDING FOR BUILDING	
<b>PRIORITY NA</b>		
<b>DESIGN NUMBER</b>	252108	
<b>CLASS</b>	28-02	
<b>1)DINESH BASTIMAL JAIN (AN INDIAN NATIONAL) AT 203/204 RAJ MADHUR CHS. DEVIDAS LANE, NR. CLUB AQUERIA, BORIVALI (WEST) MUMBAI 400103, STATE OF MAHARASHTRA, INDIA</b>		
<b>DATE OF REGISTRATION</b>	05/03/2013	
<b>TITLE</b>	BOTTLE OF EYE MASKARA	
<b>PRIORITY NA</b>		

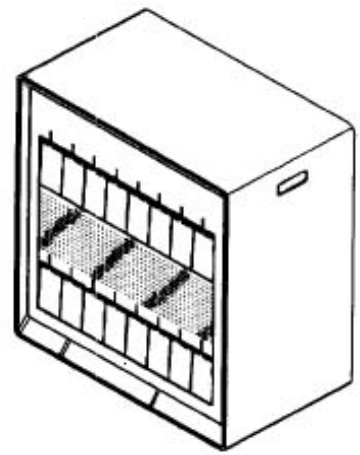
<b>DESIGN NUMBER</b>	251478		
<b>CLASS</b>	15-99		
<b>1)KLAD ON DESIGN PVT LTD, HAVING PLACE OF BUSINESS AT- #5&amp;6, SURVEY NO 38/2, NADAKERAPPA INDUSTRIAL ESTATE, ANDRAHALLI MAIN ROAD, NEAR PEENYA 2ND STAGE, BANGALORE-560091</b>			
<b>DATE OF REGISTRATION</b>	07/02/2013		
<b>TITLE</b>	MACHINE ENCLOSURE FOR COMPUTER NUMERICAL CONTROL TURNING MACHINE		
<b>PRIORITY NA</b>			
<b>DESIGN NUMBER</b>	251525		
<b>CLASS</b>	12-11		
<b>1)BAJAJ AUTO LIMITED, AN INDIAN COMPANY, INCORPORATED UNDER THE COMPANIES ACT OF 1956, HAVING ITS PRINCIPAL PLACE OF BUSINESS AT NEW 2ND &amp; 3RD FLOOR, KHIVRAJ BUILDING, NO. 616, ANNASALAI, CHENNAI - 600006, STATE OF TAMIL NADU, INDIA, AND REGISTERED OFFICE AT AKURDI, PUNE-411035, STATE OF MAHARASHTRA, INDIA</b>			
<b>DATE OF REGISTRATION</b>	08/02/2013		
<b>TITLE</b>	FRONT BEZEL FOR MOTORCYCLE		
<b>PRIORITY NA</b>			
<b>DESIGN NUMBER</b>	246936		
<b>CLASS</b>	24-02		
<b>1)CEPHEID, A CORPORATION OF THE STATE OF CALIFORNIA OF 904 CARIBBEAN DRIVE, SUNNYVALE, CALIFORNIA 94089, UNITED STATES OF AMERICA</b>			
<b>DATE OF REGISTRATION</b>	03/08/2012		
<b>TITLE</b>	MOLECULAR DIAGNOSTIC DEVICE		
<b>PRIORITY</b>			
<b>PRIORITY NUMBER</b>	<b>DATE</b>	<b>COUNTRY</b>	
29/412, 453	03/02/2012	U.S.A.	



<b>DESIGN NUMBER</b>	229088	
<b>CLASS</b>	10-07	
1)SEIKO INSTRUMENTS INC., 8, NAKASE 1-CHOME, MIHAMA-KU, CHIBA-SHI, CHIBA, JAPAN		
<b>DATE OF REGISTRATION</b>	04/05/2010	
<b>TITLE</b>	EQUIPMENT FOR PRODUCING ELECTRICAL SIGNAL	
<b>PRIORITY</b>		
<b>PRIORITY NUMBER</b>	<b>DATE</b>	<b>COUNTRY</b>
2010-007711	29/03/2010	JAPAN

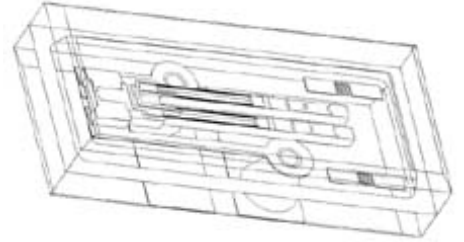



<b>DESIGN NUMBER</b>	250980	
<b>CLASS</b>	12-08	
1)TOYOTA JIDOSHA KABUSHIKI KAISHA, A JAPANESE CO., OF 1, TOYOTA-CHO, TOYOTA-SHI, AICHI-KEN, 471-8571, JAPAN		
<b>DATE OF REGISTRATION</b>	15/01/2013	
<b>TITLE</b>	CAR	
<b>PRIORITY</b>		
<b>PRIORITY NUMBER</b>	<b>DATE</b>	<b>COUNTRY</b>
2012-019031	08/08/2012	JAPAN



<b>DESIGN NUMBER</b>	252423	
<b>CLASS</b>	06-01	
1)STEELCASE INC., 901-44TH STREET, S.E., GRAND RAPIDS, MICHIGAN 49508 USA, NATIONALITY: USA		
<b>DATE OF REGISTRATION</b>	19/03/2013	
<b>TITLE</b>	CHAIR	
<b>PRIORITY</b>		
<b>PRIORITY NUMBER</b>	<b>DATE</b>	<b>COUNTRY</b>
29/432,780	20/09/2012	U.S.A.



<b>DESIGN NUMBER</b>	251251		
<b>CLASS</b>	12-15		
<b>1)METRO TYRES LIMITED, A COMPANY INCORPORATED UNDER THE INDIAN COMPANIES ACT, 1956, NATIONALITY- INDIAN COMPANY, ADDRESS:</b> B-3 & B-4, SECTOR-58, NOIDA-201301, U.P.			
<b>DATE OF REGISTRATION</b>	28/01/2013		
<b>TITLE</b>	TYRE		
<b>PRIORITY NA</b>			
<b>DESIGN NUMBER</b>	251435		
<b>CLASS</b>	21-02		
<b>1)ZEDEL (SOCIÉTÉ PAR ACTIONS SIMPLIFIÉE), A FRENCH COMPANY OF ZONE INDUSTRIELLE DE CROLLES, 38920 CROLLES, FRANCE (FR)</b>			
<b>DATE OF REGISTRATION</b>	05/02/2013		
<b>TITLE</b>	CARABINER		
<b>PRIORITY</b>			
<b>PRIORITY NUMBER</b>	<b>DATE</b>	<b>COUNTRY</b>	
002084566-0001	07/08/2012	OHIM	
<b>DESIGN NUMBER</b>	253221		
<b>CLASS</b>	01-01		
<b>1)M/S. GANDOUR INDIA FOOD PROCESSING PVT. LTD., AN INDIAN, A COMPANY INCORPORATED UNDER THE COMPANIES ACT, 1956, HAVING ITS PLACE OF BUSINESS AT</b> SURVEY NO. 172 & 173, PHASE IV, IDA, CHERLAPALLY, RANGA REDDY DISTRICT-500051, HYDERABAD, A.P, INDIA			
<b>DATE OF REGISTRATION</b>	18/04/2013		
<b>TITLE</b>	WAFER BAR		
<b>PRIORITY NA</b>			

<b>DESIGN NUMBER</b>	253261	
<b>CLASS</b>	08-07	
<b>1)ROYAL, AN INDIAN PARTNERSHIP FIRM AT C-2/314, G.I.D.C., SHANKERTEKARI UDYOG NAGAR, JAMNAGAR-361004, GUJARAT, (INDIA)</b> WHOSE PARTNERS ARE AMRUTLAL SAMAT HARIA, AMRUTLAL NARSHI KHIMASIA AND SARLABEN SAVLA, ALL INDIAN OF ABOVE ADDRESS		
<b>DATE OF REGISTRATION</b>	19/04/2013	
<b>TITLE</b>	TOWER BOLT	
<b>PRIORITY NA</b>		
<b>DESIGN NUMBER</b>	253367	
<b>CLASS</b>	23-03	
<b>1)ELICA PB INDIA PRIVATE LIMITED, A COMPANY REGISTERED UNDER THE PROVISION OF INDIAN COMPANIES ACT, 1956, HAVING OFFICE ADDRESS</b> AT 37/1/1, KONDHWA PISOLI ROAD, PISOLI, PUNE-411028, MAHARASHTRA, INDIA		
<b>DATE OF REGISTRATION</b>	23/04/2013	
<b>TITLE</b>	PLATE USED IN GAS STOVES	
<b>PRIORITY NA</b>		
<b>DESIGN NUMBER</b>	248217	
<b>CLASS</b>	06-01	
<b>1)NILKAMAL LIMITED</b> OF SURVEY NO. - 354/2 & 354/3, NEAR RAKHOLI BRIDGE, SILVASSA - KHANVEL ROAD, VILLAGE VASONA, SILVASSA ( D & N. H.), (U. T.), INDIA, INDIAN COMPANY		
<b>DATE OF REGISTRATION</b>	27/09/2012	
<b>TITLE</b>	CHAIR	
<b>PRIORITY NA</b>		

<b>DESIGN NUMBER</b>	252095	
<b>CLASS</b>	28-02	
<b>1)DINESH BASTIMAL JAIN (AN INDIAN NATIONAL) AT</b> 203/204 RAJ MADHUR CHS. DEVIDAS LANE, NR. CLUB AQUERIA, BORIVALI (WEST) MUMBAI 400103, STATE OF MAHARASHTRA, INDIA		
<b>DATE OF REGISTRATION</b>	05/03/2013	
<b>TITLE</b>	BOTTLE FOR NAIL POLISH	
<b>PRIORITY NA</b>		
<b>DESIGN NUMBER</b>	252106	
<b>CLASS</b>	28-02	
<b>1)DINESH BASTIMAL JAIN (AN INDIAN NATIONAL) AT</b> 203/204 RAJ MADHUR CHS. DEVIDAS LANE, NR. CLUB AQUERIA, BORIVALI (WEST) MUMBAI 400103, STATE OF MAHARASHTRA, INDIA		
<b>DATE OF REGISTRATION</b>	05/03/2013	
<b>TITLE</b>	BOTTLE FOR NAIL POLISH	
<b>PRIORITY NA</b>		
<b>DESIGN NUMBER</b>	251477	
<b>CLASS</b>	15-99	
<b>1)KLAD ON DESIGN PVT LTD, HAVING PLACE OF BUSINESS AT-</b> #5&6, SURVEY NO 38/2, NADAKERAPPA INDUSTRIAL ESTATE, ANDRAHALLI MAIN ROAD, NEAR PEENYA 2ND STAGE, BANGALORE-560091		
<b>DATE OF REGISTRATION</b>	07/02/2013	
<b>TITLE</b>	MACHINE ENCLOSURE FOR VERTICAL MACHINING CENTRE	
<b>PRIORITY NA</b>		

<b>DESIGN NUMBER</b>	251683	
<b>CLASS</b>	29-02	
<b>1)USHA ARMOUR PVT. LTD.,</b> #102, 4TH A MAIN, 6TH CROSS, BILEKAHALLI, BANNERGHATTA MAIN ROAD, BANGALORE-560076, KARNATAKA, INDIA		
<b>DATE OF REGISTRATION</b>	15/02/2013	
<b>TITLE</b>	RESCUE CHAIR	
<b>PRIORITY NA</b>		

<b>DESIGN NUMBER</b>	253530	
<b>CLASS</b>	13-03	
<b>1)GOLD MEDAL ELECTRICALS PVT. LTD. A COMPANY REGISTERED</b> <b>UNDER COMPANY ACT 1956 WHOSE ADDRESS IS,</b> A/302, KEMP PLAZA, MIND SPACE, OFF LINK ROAD, CHINCHOLI BUNDER, MALAD (WEST), MUMBAI-400064, MAHARASHTRA, INDIA		
<b>DATE OF REGISTRATION</b>	30/04/2013	
<b>TITLE</b>	SWITCH COVER PLATE	
<b>PRIORITY NA</b>		

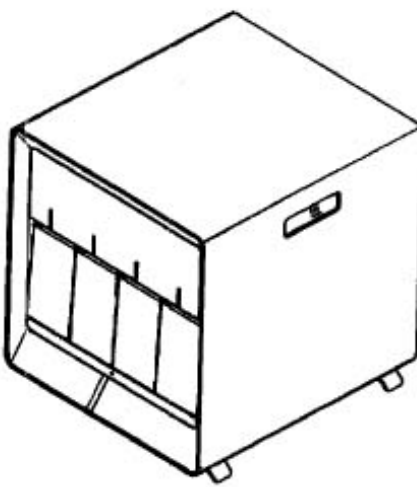
<b>DESIGN NUMBER</b>	246935	
<b>CLASS</b>	24-02	
<b>1)CEPHEID, A CORPORATION OF THE STATE OF CALIFORNIA</b> OF 904 CARIBBEAN DRIVE, SUNNYVALE, CALIFORNIA 94089, UNITED STATES OF AMERICA		
<b>DATE OF REGISTRATION</b>	03/08/2012	
<b>TITLE</b>	MOLECULAR DIAGNOSTIC DEVICE	
<b>PRIORITY</b>		
<b>PRIORITY NUMBER</b>	<b>DATE</b>	<b>COUNTRY</b>
29/412, 453	03/02/2012	U.S.A.

<b>DESIGN NUMBER</b>	251727	 <p>Perspective view</p>
<b>CLASS</b>	13-03	
<b>1) LARSEN &amp; TOUBRO LIMITED, AN INDIAN COMPANY INCORPORATED UNDER THE COMPANIES ACT, 1956 OF</b> L & T HOUSE, BALLARD ESTATE, MUMBAI 400001, STATE OF MAHARASHTRA, INDIA		
<b>DATE OF REGISTRATION</b>	18/02/2013	
<b>TITLE</b>	MOULDED CASE CIRCUIT BREAKER	
<b>PRIORITY NA</b>		
<b>DESIGN NUMBER</b>	250979	
<b>CLASS</b>	06-01	
<b>1) CRESTO RUBBER (INDIA) PVT. LTD. (AN INDIAN COMPANY REGISTERED UNDER THE COMPANIES ACT, 1956) AT</b> C-8, 1ST FLOOR, INDUSTRIAL AREA, WAZIRPUR, DELHI-110052		
<b>DATE OF REGISTRATION</b>	15/01/2013	
<b>TITLE</b>	DESK	
<b>PRIORITY NA</b>		
<b>DESIGN NUMBER</b>	251320	
<b>CLASS</b>	02-04	
<b>1) TARA CHAND GUPTA S/O. (LATE) SH. RAMESHWAR LAL (NATIONALITY-INDIAN) PROPRIETOR OF NATIONAL POLYMERS AT</b> H-523, PHASE-II, JHOTWARA EXTN. INDUSTRIAL AREA, SARANA DUNGER, JAIPUR (RAJASTHAN) INDIA		
<b>DATE OF REGISTRATION</b>	30/01/2013	
<b>TITLE</b>	FOOTWEAR	
<b>PRIORITY NA</b>		

<b>DESIGN NUMBER</b>	253236	
<b>CLASS</b>	09-01	
<b>1)TROIKAA PHARMACEUTICALS LIMITED, AN INDIAN COMPANY INCORPORATED UNDER THE COMPANIES ACT, 1956 OF "COMMERCE HOUSE-1", SATYA MARG, BODAKDEV, AHMEDABAD 380054, STATE OF GUJARAT, INDIA</b>		
<b>DATE OF REGISTRATION</b>	18/04/2013	
<b>TITLE</b>	SPRAY BOTTLE	
<b>PRIORITY NA</b>		
<b>DESIGN NUMBER</b>	253260	
<b>CLASS</b>	08-07	
<b>1)ROYAL, AN INDIAN PARTNERSHIP FIRM AT C-2/314, G.I.D.C., SHANKERTEKARI UDYOG NAGAR, JAMNAGAR-361004, GUJARAT, (INDIA) WHOSE PARTNERS ARE AMRUTLAL SAMAT HARIA, AMRUTLAL NARSHI KHIMASIA AND SARLABEN SAVLA, ALL INDIAN OF ABOVE ADDRESS</b>		
<b>DATE OF REGISTRATION</b>	19/04/2013	
<b>TITLE</b>	TOWER BOLT	
<b>PRIORITY NA</b>		
<b>DESIGN NUMBER</b>	252617	
<b>CLASS</b>	10-04	
<b>1)TURBO INDUSTRIES PRIVATE LIMITED OF SURJIT CINEMA ROAD, INDUSTRIAL AREA C', DHANDARI KALAN, LUDHIANA-141010 (PUNJAB), INDIA, AN INDIAN PRIVATE LIMITED COMPANY WHOSE MANAGING DIRECTOR IS S. RAVINDER PAL SINGH, INDIAN NATIONAL OF ABOVE ADDRESS</b>		
<b>DATE OF REGISTRATION</b>	22/03/2013	
<b>TITLE</b>	PRECAST DECK FOR WEIGH BRIDGES	
<b>PRIORITY NA</b>		

<b>DESIGN NUMBER</b>	234583	
<b>CLASS</b>	19-06	
<b>1)ADD CORPORATION LIMITED</b> BUSINESS PARK, 6TH FLOOR, CHINCHOLI NAKA, S.V. ROAD, MALAD (WEST), MUMBAI-400064, MAHARASHTRA, INDIA		
<b>DATE OF REGISTRATION</b>	15/02/2011	
<b>TITLE</b>	WRITING INSTRUMENT CAP TOP	
<b>PRIORITY NA</b>		

<b>DESIGN NUMBER</b>	251068	
<b>CLASS</b>	22-04	
<b>1)ZEN TECHNOLOGIES LIMITED, WHOSE ADDRESS IS</b> B-42, INDUSTRIAL ESTATE, SANATHNAGAR, HYDERABAD-500018, ANDHRA PRADESH AND WHOSE NATIONALITY IS INDIA		
<b>DATE OF REGISTRATION</b>	21/01/2013	
<b>TITLE</b>	MOVING TARGET SYSTEM FOR SHOOTING PRACTICE	
<b>PRIORITY NA</b>		

<b>DESIGN NUMBER</b>	252094	
<b>CLASS</b>	28-02	
<b>1)DINESH BASTIMAL JAIN (AN INDIAN NATIONAL) AT</b> 203/204 RAJ MADHUR CHS. DEVIDAS LANE, NR. CLUB AQUERIA, BORIVALI (WEST) MUMBAI 400103, STATE OF MAHARASHTRA, INDIA		
<b>DATE OF REGISTRATION</b>	05/03/2013	
<b>TITLE</b>	BOTTLE FOR NAIL POLISH	
<b>PRIORITY NA</b>		



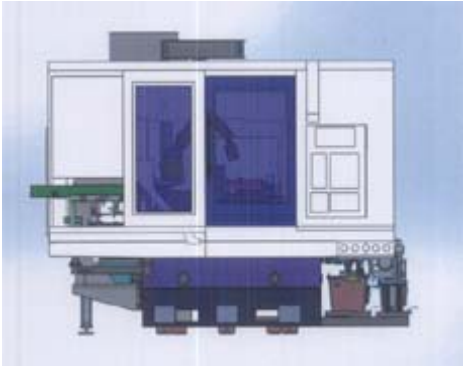

<b>DESIGN NUMBER</b>	252105	
<b>CLASS</b>	28-02	
<b>1)DINESH BASTIMAL JAIN (AN INDIAN NATIONAL) AT</b> 203/204 RAJ MADHUR CHS. DEVIDAS LANE, NR. CLUB AQUERIA, BORIVALI (WEST) MUMBAI 400103, STATE OF MAHARASHTRA, INDIA		
<b>DATE OF REGISTRATION</b>	05/03/2013	
<b>TITLE</b>	BOTTLE FOR NAIL POLISH	
<b>PRIORITY NA</b>		

<b>DESIGN NUMBER</b>	251476	
<b>CLASS</b>	15-99	
<b>1)KLAD ON DESIGN PVT LTD, HAVING PLACE OF BUSINESS AT-</b> #5&6, SURVEY NO 38/2, NADAKERAPPA INDUSTRIAL ESTATE, ANDRAHALLI MAIN ROAD, NEAR PEENYA 2ND STAGE, BANGALORE-560091		
<b>DATE OF REGISTRATION</b>	07/02/2013	
<b>TITLE</b>	MACHINE ENCLOSURE FOR GRINDING MACHINE	
<b>PRIORITY NA</b>		

<b>DESIGN NUMBER</b>	251488	
<b>CLASS</b>	15-99	
<b>1)KLAD ON DESIGN PVT LTD, HAVING PLACE OF BUSINESS AT-</b> #5&6, SURVEY NO 38/2, NADAKERAPPA INDUSTRIAL ESTATE, ANDRAHALLI MAIN ROAD, NEAR PEENYA 2ND STAGE, BANGALORE-560091		
<b>DATE OF REGISTRATION</b>	07/02/2013	
<b>TITLE</b>	MACHINE ENCLOSURE FOR COMPUTER NUMERICAL CONTROL TURNING	
<b>PRIORITY NA</b>		

<b>DESIGN NUMBER</b>	253529	
<b>CLASS</b>	13-03	
<b>1)GOLD MEDAL ELECTRICALS PVT. LTD. A COMPANY REGISTERED UNDER COMPANY ACT 1956 WHOSE ADDRESS IS, A/302, KEMP PLAZA, MIND SPACE, OFF LINK ROAD, CHINCHOLI BUNDER, MALAD (WEST), MUMBAI-400064, MAHARASHTRA, INDIA</b>		
<b>DATE OF REGISTRATION</b>	30/04/2013	
<b>TITLE</b>	SWITCH COVER PLATE	
<b>PRIORITY NA</b>		

<b>DESIGN NUMBER</b>	252382		
<b>CLASS</b>	14-03		
<b>1)KONINKLIJKE PHILIPS ELECTRONICS N.V., A COMPANY ORGANIZED AND EXISTING UNDER THE LAWS OF THE KINGDOM OF THE NETHERLANDS, RESIDING AT EINDHOVEN, WHOSE POST-OFFICE ADDRESS IS HIGH TECH CAMPUS 5, 5656 AE EINDHOVEN, THE NETHERLANDS</b>			
<b>DATE OF REGISTRATION</b>	18/03/2013		
<b>TITLE</b>	REMOTE CONTROL UNIT		
<b>PRIORITY</b>			
<b>PRIORITY NUMBER</b>	<b>DATE</b>	<b>COUNTRY</b>	
002105916-0002	19/09/2012	OHIM	

<b>DESIGN NUMBER</b>	253364		
<b>CLASS</b>	10-02		
<b>1)TURLEN HOLDING SA, A SWISS COMPANY, C/O SIPO S.A., CHEMIN DU CHÂTEAU 26A, 2805 SOYHIÈRES, SWITZERLAND</b>			
<b>DATE OF REGISTRATION</b>	23/04/2013		
<b>TITLE</b>	WATCH		
<b>PRIORITY</b>			
<b>PRIORITY NUMBER</b>	<b>DATE</b>	<b>COUNTRY</b>	
699495801	25/10/2012	WIPO	

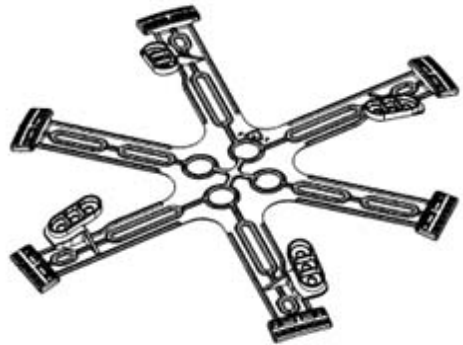
<b>DESIGN NUMBER</b>	252547	
<b>CLASS</b>	02-03	
<b>1)JSP LTD, A UK CORPORATION, WORSHAM MILL, MINSTER LOVELL, OXFORD, OX29 0TA, UNITED KINGDOM</b>		
<b>DATE OF REGISTRATION</b>	20/03/2013	
<b>TITLE</b>	SAFETY HELMET INTERNAL HARNESS	
<b>PRIORITY NA</b>		

<b>DESIGN NUMBER</b>	252091	
<b>CLASS</b>	28-02	
<b>1)DINESH BASTIMAL JAIN (AN INDIAN NATIONAL) AT 203/204 RAJ MADHUR CHS. DEVIDAS LANE, NR. CLUB AQUERIA, BORIVALI (WEST) MUMBAI 400103, STATE OF MAHARASHTRA, INDIA</b>		
<b>DATE OF REGISTRATION</b>	05/03/2013	
<b>TITLE</b>	BOTTLE FOR NAIL POLISH	
<b>PRIORITY NA</b>		

<b>DESIGN NUMBER</b>	252104	
<b>CLASS</b>	28-02	
<b>1)DINESH BASTIMAL JAIN (AN INDIAN NATIONAL) AT 203/204 RAJ MADHUR CHS. DEVIDAS LANE, NR. CLUB AQUERIA, BORIVALI (WEST) MUMBAI 400103, STATE OF MAHARASHTRA, INDIA</b>		
<b>DATE OF REGISTRATION</b>	05/03/2013	
<b>TITLE</b>	BOTTLE FOR NAIL POLISH	
<b>PRIORITY NA</b>		

<b>DESIGN NUMBER</b>	252124	
<b>CLASS</b>	21-01	
<b>1)INNOVATION FIRST, INC. ADDRESS AT</b> 1519 INTERSTATE 30 WEST GREENVILLE, TEXAS 75402, UNITED STATES OF AMERICA		
<b>DATE OF REGISTRATION</b>	06/03/2013	
<b>TITLE</b>	TOY	
<b>PRIORITY</b>		
<b>PRIORITY NUMBER</b>	<b>DATE</b>	<b>COUNTRY</b>
29/432,774	20/09/2012	U.S.A.



<b>DESIGN NUMBER</b>	251475	
<b>CLASS</b>	15-99	
<b>1)KLAD ON DESIGN PVT LTD, HAVING PLACE OF BUSINESS AT-</b> #5&6, SURVEY NO 38/2, NADAKERAPPA INDUSTRIAL ESTATE, ANDRAHALLI MAIN ROAD, NEAR PEENYA 2ND STAGE, BANGALORE-560091		
<b>DATE OF REGISTRATION</b>	07/02/2013	
<b>TITLE</b>	MACHINE ENCLOSURE FOR MICRO STEREOLITHO GRAPHIC MACHINE	
<b>PRIORITY NA</b>		



<b>DESIGN NUMBER</b>	251487	
<b>CLASS</b>	15-99	
<b>1)KLAD ON DESIGN PVT LTD, HAVING PLACE OF BUSINESS AT-</b> #5&6, SURVEY NO 38/2, NADAKERAPPA INDUSTRIAL ESTATE, ANDRAHALLI MAIN ROAD, NEAR PEENYA 2ND STAGE, BANGALORE-560091		
<b>DATE OF REGISTRATION</b>	07/02/2013	
<b>TITLE</b>	MACHINE ENCLOSURE FOR INTERNAL GRINDING MACHINE	
<b>PRIORITY NA</b>		

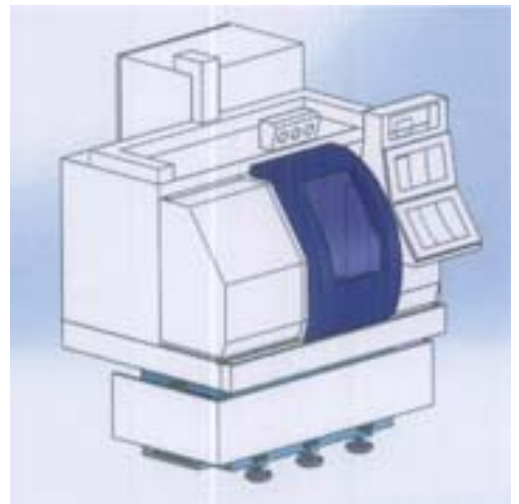

<b>DESIGN NUMBER</b>	251600	
<b>CLASS</b>	24-02	
<b>1)EPPENDORF AG, ADDRESS AT</b> BARKHAUSENWEG 1, 22339 HAMBURG, GERMANY, A GERMAN COMPANY		
<b>DATE OF REGISTRATION</b>	13/02/2013	
<b>TITLE</b>	THERMOMIXER	
<b>PRIORITY</b>		
<b>PRIORITY NUMBER</b>	<b>DATE</b>	<b>COUNTRY</b>
40 2012 003 937.3	27/08/2012	GERMANY



<b>DESIGN NUMBER</b>	251630	
<b>CLASS</b>	31-00	
<b>1)KAUSHIK C. JOSHI AN INDIAN NATIONAL AND RESIDING AT</b> 122, VIBHUSHA BUNGLOWS, OPP. HOMEOPATHIC COLLEGE, BOPAL GHUMA ROAD, BOPAL, AHMEDABAD-58 GUJARAT. (INDIA)		
<b>DATE OF REGISTRATION</b>	14/02/2013	
<b>TITLE</b>	CUTTING MACHINES FOR FRUIT	
<b>PRIORITY NA</b>		



<b>DESIGN NUMBER</b>	253522	
<b>CLASS</b>	13-03	
<b>1)GOLD MEDAL ELECTRICALS PVT. LTD. A COMPANY REGISTERED UNDER COMPANY ACT 1956 WHOSE ADDRESS IS,</b> A/302, KEMP PLAZA, MIND SPACE, OFF LINK ROAD, CHINCHOLI BUNDER, MALAD (WEST), MUMBAI-400064, MAHARASHTRA, INDIA		
<b>DATE OF REGISTRATION</b>	30/04/2013	
<b>TITLE</b>	SWITCH COVER PLATE	
<b>PRIORITY NA</b>		

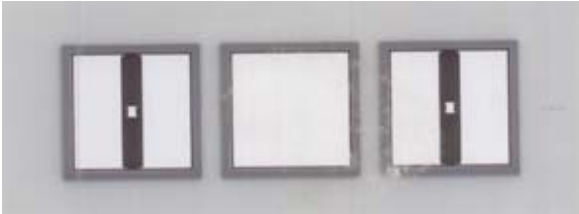

<b>DESIGN NUMBER</b>	246933		
<b>CLASS</b>	24-02		
<b>1) CEPHEID, A CORPORATION OF THE STATE OF CALIFORNIA</b> OF 904 CARIBBEAN DRIVE, SUNNYVALE, CALIFORNIA 94089, UNITED STATES OF AMERICA			
<b>DATE OF REGISTRATION</b>	03/08/2012		
<b>TITLE</b>	MOLECULAR DIAGNOSTIC DEVICE		
<b>PRIORITY</b>			
<b>PRIORITY NUMBER</b>	<b>DATE</b>	<b>COUNTRY</b>	
29/412, 453	03/02/2012	U.S.A.	
<b>DESIGN NUMBER</b>	251743		
<b>CLASS</b>	23-01		
<b>1)(1) AMITBHAI DHIRAJLAL MALAVIA (2) MAHESHBHAI VASRAMBHAI TOLIYA (BOTH THE PARTNERS ARE INDIAN NATIONAL) PARTNERS OF UFLOW AUTOMATION (INDIAN PARTNERSHIP FIRM) HAVING PLACE OF BUSINESS AT-</b> ANKUR INDUSTRIAL COMPLEX, SURVEY NO. 275/276, PLOT NO. 31, NR. INTOL CAST PVT LTD, SHAPER-VERAVAL-360024 DISTRICT: RAJKOT-GUJARAT (INDIA)			
<b>DATE OF REGISTRATION</b>	19/02/2013		
<b>TITLE</b>	PNEUMATIC PRESSURE CONTROL VALVE		
<b>PRIORITY NA</b>			
<b>DESIGN NUMBER</b>	251825		
<b>CLASS</b>	23-02		
<b>1) EURO-ANCHOR SANITARYWARE INDUSTRIES PVT LTD, A COMPANY INCORPORATED UNDER THE INDIAN COMPANIES ACT, HAVING ITS REGISTERED OFFICE AT</b> OPP. JAMVALI BUS STOP, CHOTILA ROAD, THANGADH 363530, DIST: SURENDRANAGAR, GUJARAT, INDIA			
<b>DATE OF REGISTRATION</b>	22/02/2013		
<b>TITLE</b>	WATER CLOSET		
<b>PRIORITY NA</b>			

<b>DESIGN NUMBER</b>	253768	
<b>CLASS</b>	06-08	
<b>1)MAINETTI (UK) LIMITED, A COMPANY INCORPORATED IN SCOTLAND OF</b> ANNFIELD ESTATE, OXNAM ROAD, JEDBURGH, ROXBURGHSHIRE, SCOTLAND, TD8 6NN, UNITED KINGDOM		
<b>DATE OF REGISTRATION</b>	09/05/2013	
<b>TITLE</b>	GARMENT HANGER	
<b>PRIORITY</b>		
<b>PRIORITY NUMBER</b>	<b>DATE</b>	<b>COUNTRY</b>
4027416	12/11/2012	U.K.



<b>DESIGN NUMBER</b>	253186	
<b>CLASS</b>	23-02	
<b>1)NAVEEN CHAUHAN IS INDIAN, TRADING AS K.C. ENTERPRISES (THIS COMPANY IS SOLE PROPRIETORSHIP FIRM) WHOSE ADDRESS IS</b> A-170, GROUND FLOOR, MAIN M.G.ROAD, AMBEDKAR COLONY, CHATTARPUR, NEW DELHI-110074		
<b>DATE OF REGISTRATION</b>	16/04/2013	
<b>TITLE</b>	URINAL SCREEN	
<b>PRIORITY NA</b>		



<b>DESIGN NUMBER</b>	253233	
<b>CLASS</b>	23-01	
<b>1)TOYOX CO., LTD.</b> 4371, MAEZAWA, KUROBE-SHI, TOYAMA-KEN, JAPAN, A JAPANESE COMPANY		
<b>DATE OF REGISTRATION</b>	18/04/2013	
<b>TITLE</b>	HOSE CONNECTOR	
<b>PRIORITY</b>		
<b>PRIORITY NUMBER</b>	<b>DATE</b>	<b>COUNTRY</b>
2012-25396	18/10/2012	JAPAN

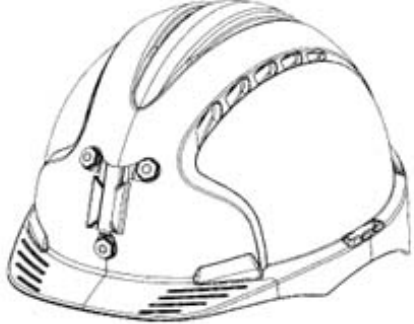

<b>DESIGN NUMBER</b>	253275	
<b>CLASS</b>	08-06	
<b>1)ALPESHBHAI B. PATEL AND PARESHBHAI M. PATEL BOTH INDIAN NATIONAL PARTNERS OF S. P. METAL AN INDIAN PARTNERSHIP FIRM HAVING ITS PRINCIPAL PLACE OF BUSINESS AT ADDRESS :-</b> “PRANAM” , JAY SIYARAM INDUSTRIAL ESTATE, NEAR MIRA UDHYOG, BALAJI POLYMERS STREET, AJI RING ROAD HIGHWAY, RAJKOT, GUJARAT-INDIA		
<b>DATE OF REGISTRATION</b>	22/04/2013	
<b>TITLE</b>	HANDLE	
<b>PRIORITY NA</b>		
<b>DESIGN NUMBER</b>	252545	
<b>CLASS</b>	02-03	
<b>1)JSP LTD, A UK CORPORATION,</b> WORSHAM MILL, MINSTER LOVELL, OXFORD, OX29 0TA, UNITED KINGDOM		
<b>DATE OF REGISTRATION</b>	20/03/2013	
<b>TITLE</b>	SAFETY HELMET	
<b>PRIORITY NA</b>		