



**INTRODUCTION**

In view of the recent amendment made in the Designs (Amendment) Rules, 2008 with effect from 17/06/2008, Publication of the matter relating to Designs is being published in the Official Journal of The Patent Office. This Journal is being published on weekly basis on every Friday covering the various proceedings on Designs as required according to the provisions of under Rule 22, 25, 27 and 39 of the Design (Amendment) Rules, 2008. All the enquiries on this Official Journal and other information as required by the public should be addressed to the Controller General of Patents, Designs & Trade Marks. Suggestions and comments are requested from all quarters so that the content can be enriched.

## REGISTRATION OF DESIGNS

The following designs have been registered. They are now open for public inspection. In the following each entry the Date of Registration is shown. The Priority Number, Priority Date and Priority Country are also shown

<b>Design Number</b>	318513-001	
<b>Class</b>	03-01	
<b>SMS Scientific Products Pvt. Ltd., Plot No. 94, The Vasai Taluka Co., Op. Industrial Estate, Gauripada, Vasai (East), Mumbai - 401208, Maharashtra, India.</b>		
<b>Date of Registration</b>	06/06/2019	
<b>Title</b>	PLASTIC BOX FOR UTILITY KITS AND MEDICAL KIT	
<b>Priority NA</b>		
<b>Design Number</b>	320068-001	
<b>Class</b>	24-04	
<b>VIGAMED PRODUCTS PRIVATE LIMITED, F No. B-5, Shree Avenue APPTT. Opp, Narayan Nagar, Kalptaru Nagar, Ashoka Marg, Nashik, Maharashtra-422006, India</b>		
<b>Date of Registration</b>	26/07/2019	
<b>Title</b>	EXTERNAL RETENTION RING FOR FEMALE CONDOM	
<b>Priority NA</b>		
<b>Design Number</b>	320168-001	
<b>Class</b>	02-02	
<b>SABYASACHI COUTURE, 86C, Jatin Das Road, Kolkata- 700029, State of West Bengal, whose Partners are MR. SUKUMAR MUKHERJEE and MR. SABYASACHI MUKHERJEE.</b>		
<b>Date of Registration</b>	30/07/2019	
<b>Title</b>	GARMENT SET	
<b>Priority NA</b>		

<b>Design Number</b>	320181-001		
<b>Class</b>	02-02		
<b>SABYASACHI COUTURE, 86C, Jatin Das Road, Kolkata- 700029, State of West Bengal, whose Partners are MR. SUKUMAR MUKHERJEE and MR. SABYASACHI MUKHERJEE.</b>			
<b>Date of Registration</b>	30/07/2019		
<b>Title</b>	GARMENT (SET)		
<b>Priority NA</b>			
<b>Design Number</b>	320298-001		
<b>Class</b>	02-02		
<b>SABYASACHI COUTURE, 86C, Jatin Das Road, Kolkata- 700029, State of West Bengal, whose Partners are MR. SUKUMAR MUKHERJEE and MR. SABYASACHI MUKHERJEE.</b>			
<b>Date of Registration</b>	01/08/2019		
<b>Title</b>	GARMENT (SET)		
<b>Priority NA</b>			
<b>Design Number</b>	311914		
<b>Class</b>	24-02		
<b>Ethicon LLC, #475 Street C, Suite 401 Los Frailes Industrial Park Guaynabo, Puerto Rico, 00969</b>			
<b>Date of Registration</b>	13/11/2018		
<b>Title</b>	SURGICAL STAPLER		
<b>Priority</b>			
<b>Priority Number</b>	<b>Date</b>	<b>Country</b>	
29/647,858	16/05/2018	U.S.A.	

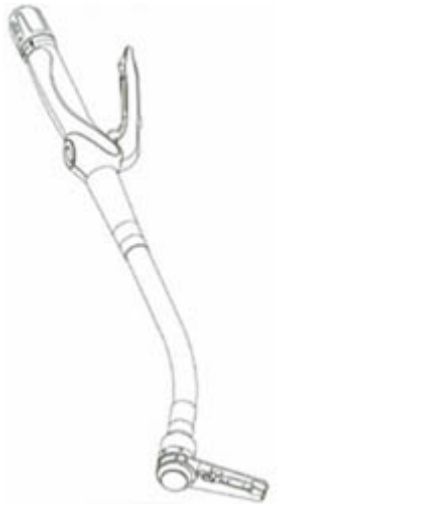
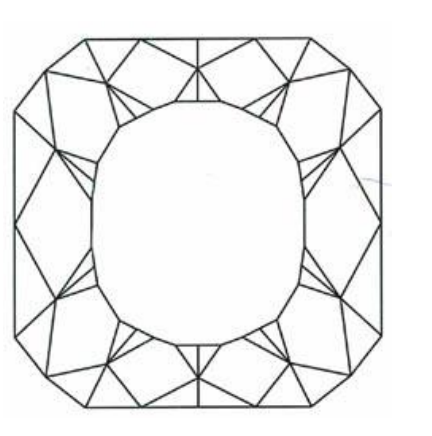
<b>Design Number</b>	311926		
<b>Class</b>	24-02		
<b>Ethicon LLC, #475 Street C, Suite 401 Los Frailes Industrial Park Guaynabo, Puerto Rico, 00969</b>			
<b>Date of Registration</b>	13/11/2018		
<b>Title</b>	SURGICAL STAPLER		
<b>Priority</b>			
<b>Priority Number</b>	<b>Date</b>	<b>Country</b>	
29/647,860	16/05/2018	U.S.A.	
<b>Design Number</b>			
312507			
<b>Class</b>	11-01		
<b>World Trend Enterprises Limited, C/o Thomas, Mayer &amp; Associates, Suite 2101, 21/F, Tower One, Lippo Center, 89 Queensway, Hong Kong</b>			
<b>Date of Registration</b>	28/11/2018		
<b>Title</b>	DIAMOND		
<b>Priority</b>			
<b>Priority Number</b>	<b>Date</b>	<b>Country</b>	
005285467-0001	28/05/2018	EUIPO	
<b>Design Number</b>			
324487-001			
<b>Class</b>	25-01		
<b>BHARAT FLOORINGS &amp; TILES (MUMBAI) PVT LTD, 32, Mumbai Samachar Marg, Fort, Mumbai-400023, State of Maharashtra, India.</b>			
<b>Date of Registration</b>	07/12/2019		
<b>Title</b>	TILE		
<b>Priority NA</b>			

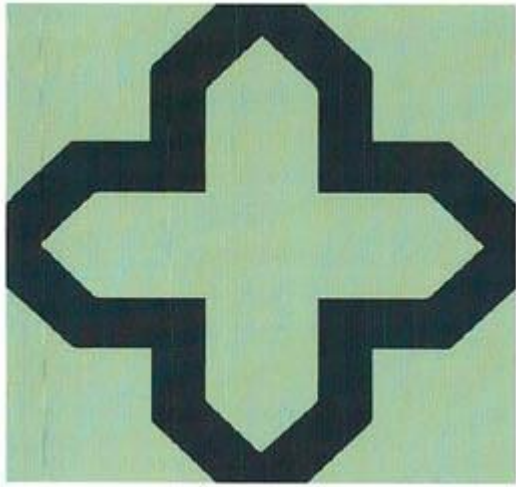
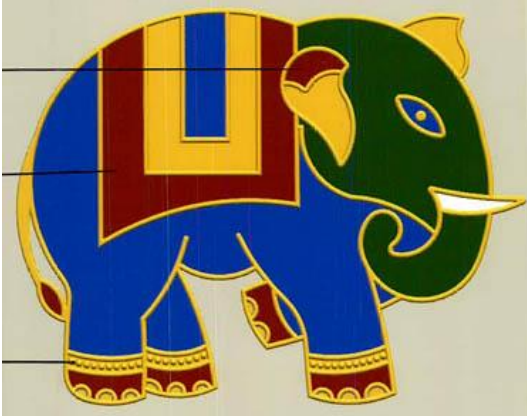
<b>Design Number</b>	324491-001	
<b>Class</b>	25-01	
<b>BHARAT FLOORINGS &amp; TILES (MUMBAI) PVT LTD, 32, Mumbai Samachar Marg, Fort, Mumbai-400023, State of Maharashtra, India.</b>		
<b>Date of Registration</b>	07/12/2019	
<b>Title</b>	TILE	
<b>Priority NA</b>		
<b>Design Number</b>	324498-001	
<b>Class</b>	25-01	
<b>BHARAT FLOORINGS &amp; TILES (MUMBAI) PVT LTD, 32, Mumbai Samachar Marg, Fort, Mumbai-400023, State of Maharashtra, India</b>		
<b>Date of Registration</b>	07/12/2019	
<b>Title</b>	TILE	
<b>Priority NA</b>		
<b>Design Number</b>	324782-001	
<b>Class</b>	11-05	
<b>Hiren Pratap Shah, YES CREATION SHOP NO 7, JAI SAKET SOCIETY, OPP VIJAYA BHAVAN, RAIPADA, MALAD (WEST), MUMBAI-400064</b>		
<b>Date of Registration</b>	17/12/2019	
<b>Title</b>	FESTIVE DECORATIVE ARTICLE	
<b>Priority NA</b>		

<b>Design Number</b>	304627	
<b>Class</b>	08-07	
<b>RYNAN TECHNOLOGIES PTE LTD., 60 Paya Lebar Road, #10-39 Paya Lebar Square, Singapore 409051.</b>		
<b>Date of Registration</b>	10/04/2018	
<b>Title</b>	Door Lock	
<b>Priority</b>		
Priority Number	Date	Country
177946	02/11/2017	Canada

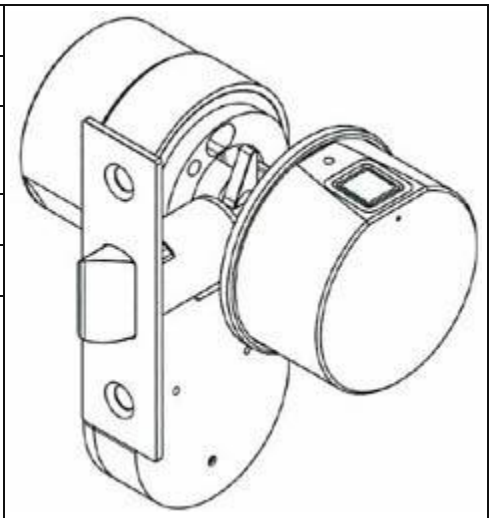



<b>Design Number</b>	316030-001	
<b>Class</b>	23-01	
<b>TOTO LTD., 1-1, Nakashima 2-chome, Kokurakita-ku, Kitakyushu-shi, Fukuoka 802-8601 Japan</b>		
<b>Date of Registration</b>	25/03/2019	
<b>Title</b>	FAUCET	
<b>Priority</b>		
Priority Number	Date	Country
2018-028767	27/12/2018	Japan

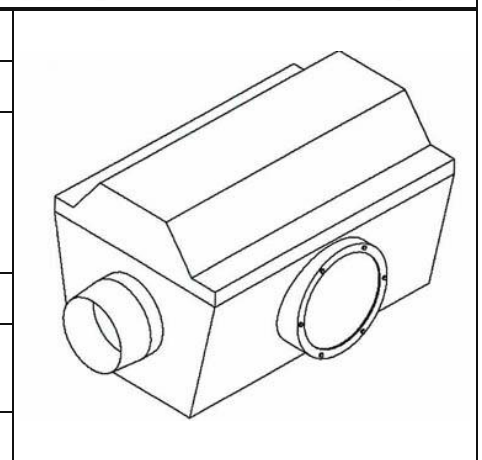

<b>Design Number</b>	326686-001	
<b>Class</b>	24-01	
<b>1. Dr. Pankajkumar Paragbhai Gohil, 34, Megh Milap Vatika, Near Nebula Appartment, Behind Subhash Garden, Jahangirabad, Surat 395005, Gujarat. 2. Dr. Viswanath Chavali, Orthopedic department, Medical college, Baroda, Vadodara – 390001, Gujarat.</b>		
<b>Date of Registration</b>	01/02/2020	
<b>Title</b>	HEX TYPE SEMI HYPERBARIC OXYGEN CHAMBER	
<b>Priority NA</b>		

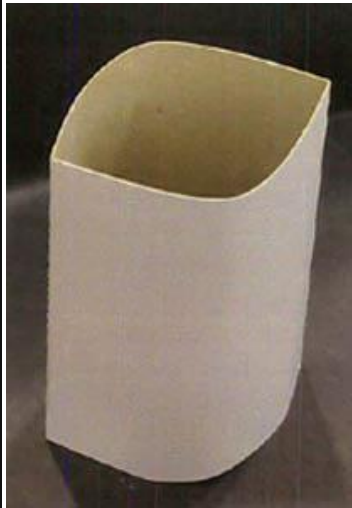
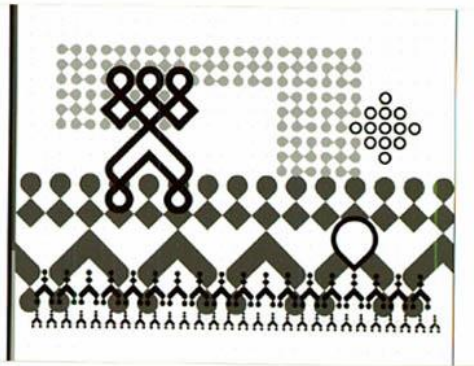

<b>Design Number</b>	326698-001	
<b>Class</b>	09-03	
<b>Yogesh Shashikumar Savadekar, Plot No.96, Kusum , National Co-Op. Hsg Society Ltd., ITI Road, Aundh , Pune 411007, Maharashtra, India.</b>		
<b>Date of Registration</b>	01/02/2020	
<b>Title</b>	PACKAGING BOX	
<b>Priority NA</b>		
<b>Design Number</b>	326795-004	
<b>Class</b>	06-11	
<b>1. Tania Singh Khosla, No. 18, 17th Main, Hall 2nd a Stage, Indiranagar, Bangalore - 560008, Karnataka, India. 2. Sandeep Khosla, No. 18, 17th Main, Hall 2nd a Stage, Indiranagar, Bangalore - 560008, Karnataka, India.</b>		
<b>Date of Registration</b>	05/02/2020	
<b>Title</b>	CARPET	
<b>Priority NA</b>		
<b>Design Number</b>	327018-001	
<b>Class</b>	28-03	
<b>MOHAMMED HANIF KAPADIA, 2704, A-WING, ORCHID ENCLAVE, BELLASIS ROAD, MUMBAI CENTRAL, MUMBAI - 400008</b>		
<b>Date of Registration</b>	10/02/2020	
<b>Title</b>	HAIR TRIMMER	
<b>Priority NA</b>		

<b>Design Number</b>	327047-001	
<b>Class</b>	24-04	
<b>Sungreen Herbal Vision, No. 1703, 46th Street, Phase II, Sathuvachari, Vellore - 632 009, Tamil Nadu, whose Partners are S. K. Sabapathy and Ritha Sabapathy</b>		
<b>Date of Registration</b>	11/02/2020	
<b>Title</b>	INHALER AND ROLL ON	
<b>Priority NA</b>		

<b>Design Number</b>	327123-001
<b>Class</b>	02-04
<b>BALDEV SINGH, A-71, NARAINA INDUSTRIAL AREA, PHASE-I, NEW DELHI-110028.</b>	
<b>Date of Registration</b>	13/02/2020
<b>Title</b>	SHOE
<b>Priority NA</b>	



<b>Design Number</b>	316664-007
<b>Class</b>	23-02
<b>HSIL Limited, 2 Red Cross, Kolkata - 700001, West Bengal, India.</b>	
<b>Date of Registration</b>	11/04/2019
<b>Title</b>	Water closet
<b>Priority NA</b>	

