

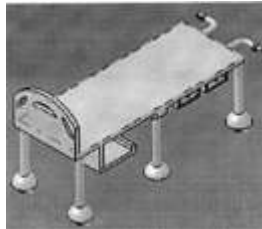



INTRODUCTION



In view of the recent amendment made in the Designs (Amendment) Rules, 2008 with effect from 17/06/2008, Publication of the matter relating to Designs is being published in the Official Journal of The Patent Office. This Journal is being published on weekly basis on every Friday covering the various proceedings on Designs as required according to the provisions of under Rule 22, 25, 27 and 39 of the Design (Amendment) Rules, 2008. All the enquiries on this Official Journal and other information as required by the public should be addressed to the Controller General of Patents, Designs & Trade Marks. Suggestions and comments are requested from all quarters so that the content can be enriched.

REGISTRATION OF DESIGNS



The following designs have been registered. They are now open for public inspection. In the following each entry the Date of Registration is shown. The Priority Number, Priority Date and Priority Country are also shown

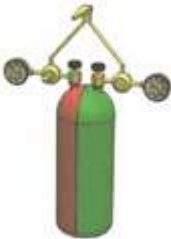

DESIGN NUMBER	316629-001		
CLASS	12-12		
1. CHITKARA INNOVATION INCUBATOR FOUNDATION, SCO: 160-161, SECTOR -9C, MADHYA MARG, CHANDIGARH- 160009, INDIA. 2. ASHISH GERA, CHITKARA UNIVERSITY, PUNJAB, PUNJAB-PATIALA NATIONAL HIGHWAY (NH4), PATIALA, 140401 3. RAVNEET KAUR, CHITKARA UNIVERSITY, PUNJAB, PUNJAB-PATIALA NATIONAL HIGHWAY (NH4), PATIALA, 140401.			
DATE OF REGISTRATION	09/04/2019		
TITLE	STRETCHERS		
PRIORITY NA			
DESIGN NUMBER	326058-001		
CLASS	14-03		
HUAWEI TECHNOLOGIES CO., LTD., HUAWEI ADMINISTRATION BUILDING, BANTIAN, LONGGANG DISTRICT, SHENZHEN, GUANGDONG 518129, P. R. CHINA			
DATE OF REGISTRATION	16/01/2020		
TITLE	MOBILE PHONE		
PRIORITY			
PRIORITY NUMBER	DATE	COUNTRY	
201930444980.8	15/08/2019	CHINA	
DESIGN NUMBER	326126-001		
CLASS	02-04		
RELAXO FOOTWEARS LIMITED, AGGARWAL CITY SQUARE, PLOT NO. 10, MANGLAM PLACE, DISTRICT CENTRE, SECTOR - 3, ROHINI, DELHI 110085			
DATE OF REGISTRATION	17/01/2020		
TITLE	FOOTWEAR		
PRIORITY NA			



DESIGN NUMBER	316265-001	
CLASS	02-04	
GLOBAL FOOTWEAR & LEATHER CRAFT INDUSTRIES (UNIT OF SK. NASIRUDDIN BIRI MERCHANTS PVT LTD), REGISTERED OFFICE AT NO. 1 RIPON STREET, KOLKATA-700016, WEST BENGAL, INDIA.		
DATE OF REGISTRATION	30/03/2019	
TITLE	FOOTWEAR	
PRIORITY NA		
DESIGN NUMBER	316378-001	
CLASS	07-04	
SHREELEKHA LAKSHMIPATHY, FLAT 5B, NO.75, CHURCH ROAD, PERUNGUDI, CHENNAI 600096		
DATE OF REGISTRATION	02/04/2019	
TITLE	FILTER COFFEE MAKER	
PRIORITY NA		
DESIGN NUMBER	326242-001	
CLASS	09-01	
RALLIS INDIA LIMITED, 23RD FLOOR, LODHA EXCELUS, NEW CUFFE PARADE, OFF ESTERN FEESWAY, WADALA, MUMBAI 400037, MAHARASHTRA, INDIA.		
DATE OF REGISTRATION	21/01/2020	
TITLE	BOTTLE	
PRIORITY NA		



DESIGN NUMBER	326244-001	
CLASS	09-01	
RALLIS INDIA LIMITED, 23RD FLOOR, LODHA EXCELUS, NEW CUFFE PARADE, OFF ESTERN FEESWAY, WADALA, MUMBAI 400037, MAHARASHTRA, INDIA,		
DATE OF REGISTRATION	21/01/2020	
TITLE	BOTTLE WITH CAP	
PRIORITY NA		
DESIGN NUMBER	326390-001	
CLASS	11-02	
HIREN PRATAP SHAH, YES CREATION SHOP NO 7, JAI SAKET SOCIETY, OPP VIJAYA BHAVAN, RAIPADA, MALAD (WEST), MUMBAI-400064		
DATE OF REGISTRATION	23/01/2020	
TITLE	DECORATIVE PLATE	
PRIORITY NA		
DESIGN NUMBER	326480-001	
CLASS	09-01	
1. BARAIYA KASHYAPKUMAR HIMMATBHAI, 54 – CHANDRA PARK-2, BEHIND LEELA BUNGALOWS, NEAR TOP 3 MULTIPLEX THEATRE, TALAJA, GUJARAT, INDIA 2. DR. CHETANKUMAR MANSUKHLAL PATEL, 54 – CHANDRA PARK-2, BEHIND LEELA BUNGALOWS, NEAR TOP 3 MULTIPLEX THEATRE, TALAJA, GUJARAT, INDIA		
DATE OF REGISTRATION	27/01/2020	
TITLE	GAS CYLINDER	
PRIORITY NA		



DESIGN NUMBER	326500-001		
CLASS	13-02		
MITSUBISHI ELECTRIC CORPORATION, 7-3, MARUNOUCHI 2-CHOME, CHIYODA-KU, TOKYO 1008310, JAPAN			
DATE OF REGISTRATION	27/01/2020		
TITLE	INVERTER		
PRIORITY			
PRIORITY NUMBER	DATE	COUNTRY	
2019-020080	09/09/2019	JAPAN	
DESIGN NUMBER	326546-010		
CLASS	02-02		
SUNIL VASUDEV DAVE, M/S VASUDEV HARGOVIND EXPORTS, C/126/2/5, GIDC, NEAR GAI ROADWAYS, BEHIND LUPIN LABS LTD, ANKLESHWAR-393002 (GUJARAT)			
DATE OF REGISTRATION	29/01/2020		
TITLE	SHIRT		
PRIORITY NA			
DESIGN NUMBER	324161-001		
CLASS	12-11		
HERO CYCLES LIMITED, HERO NAGAR, G.T. ROAD, LUDHIANA - 141003, PUNJAB, INDIA			
DATE OF REGISTRATION	30/11/2019		
TITLE	BICYCLE		
PRIORITY NA			

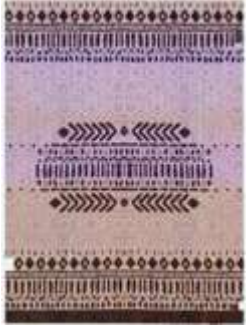

DESIGN NUMBER	324186-001	
CLASS	05-05	
BIBA APPARELS PRIVATE LIMITED, NO.4, GROUND FLOOR, DELSTAR PREMISES CHS NS PATKAR MARG, HUGES ROAD, KEMPS CORNER, MUMBAI – 400036 AND CORPORATE OFFICE AT 12TH & 13TH FLOOR CAPITAL CYBERSCAPE, SECTOR-59 GOLF COURSE EXTENSION ROAD,GURUGRAM-122102 HARYANA, INDIA.		
DATE OF REGISTRATION	02/12/2019	
TITLE	TEXTILE FABRIC	
PRIORITY NA		
DESIGN NUMBER	324189-001	
CLASS	05-05	
BIBA APPARELS PRIVATE LIMITED, NO.4, GROUND FLOOR, DELSTAR PREMISES CHS NS PATKAR MARG, HUGES ROAD, KEMPS CORNER, MUMBAI – 400036 AND CORPORATE OFFICE AT 12TH & 13TH FLOOR CAPITAL CYBERSCAPE, SECTOR-59 GOLF COURSE EXTENSION ROAD,GURUGRAM-122102 HARYANA, INDIA.		
DATE OF REGISTRATION	02/12/2019	
TITLE	TEXTILE FABRIC	
PRIORITY NA		
DESIGN NUMBER	324190-001	
CLASS	05-05	
BIBA APPARELS PRIVATE LIMITED, NO.4, GROUND FLOOR, DELSTAR PREMISES CHS NS PATKAR MARG, HUGES ROAD, KEMPS CORNER, MUMBAI – 400036 AND CORPORATE OFFICE AT 12TH & 13TH FLOOR CAPITAL CYBERSCAPE, SECTOR-59 GOLF COURSE EXTENSION ROAD,GURUGRAM-122102 HARYANA, INDIA.		
DATE OF REGISTRATION	02/12/2019	
TITLE	TEXTILE FABRIC	
PRIORITY NA		



DESIGN NUMBER	324201-001	
CLASS	05-05	
BIBA APPARELS PRIVATE LIMITED, NO.4, GROUND FLOOR, DELSTAR PREMISES CHS NS PATKAR MARG, HUGES ROAD, KEMPS CORNER, MUMBAI – 400036 AND CORPORATE OFFICE AT 12TH & 13TH FLOOR CAPITAL CYBERSCAPE, SECTOR-59 GOLF COURSE EXTENSION ROAD,GURUGRAM-122102 HARYANA, INDIA.		
DATE OF REGISTRATION	02/12/2019	
TITLE	TEXTILE FABRIC	
PRIORITY NA		
DESIGN NUMBER	324208-001	
CLASS	05-05	
BIBA APPARELS PRIVATE LIMITED, NO.4, GROUND FLOOR, DELSTAR PREMISES CHS NS PATKAR MARG, HUGES ROAD, KEMPS CORNER, MUMBAI – 400036 AND CORPORATE OFFICE AT 12TH & 13TH FLOOR CAPITAL CYBERSCAPE, SECTOR-59 GOLF COURSE EXTENSION ROAD,GURUGRAM-122102 HARYANA, INDIA.		
DATE OF REGISTRATION	02/12/2019	
TITLE	TEXTILE FABRIC	
PRIORITY NA		
DESIGN NUMBER	324211-001	
CLASS	05-05	
BIBA APPARELS PRIVATE LIMITED, NO.4, GROUND FLOOR, DELSTAR PREMISES CHS NS PATKAR MARG, HUGES ROAD, KEMPS CORNER, MUMBAI – 400036 AND CORPORATE OFFICE AT 12TH & 13TH FLOOR CAPITAL CYBERSCAPE, SECTOR-59 GOLF COURSE EXTENSION ROAD,GURUGRAM-122102 HARYANA, INDIA.		
DATE OF REGISTRATION	02/12/2019	
TITLE	TEXTILE FABRIC	
PRIORITY NA		



DESIGN NUMBER	324219-001	
CLASS	05-05	
BIBA APPARELS PRIVATE LIMITED, NO.4, GROUND FLOOR, DELSTAR PREMISES CHS NS PATKAR MARG, HUGES ROAD, KEMPS CORNER, MUMBAI – 400036 AND CORPORATE OFFICE AT 12TH & 13TH FLOOR CAPITAL CYBERSCAPE, SECTOR-59 GOLF COURSE EXTENSION ROAD,GURUGRAM-122102 HARYANA, INDIA.		
DATE OF REGISTRATION	02/12/2019	
TITLE	TEXTILE FABRIC	
PRIORITY NA		
DESIGN NUMBER	324222-001	
CLASS	05-05	
BIBA APPARELS PRIVATE LIMITED, NO.4, GROUND FLOOR, DELSTAR PREMISES CHS NS PATKAR MARG, HUGES ROAD, KEMPS CORNER, MUMBAI – 400036 AND CORPORATE OFFICE AT 12TH & 13TH FLOOR CAPITAL CYBERSCAPE, SECTOR-59 GOLF COURSE EXTENSION ROAD,GURUGRAM-122102 HARYANA, INDIA.		
DATE OF REGISTRATION	02/12/2019	
TITLE	TEXTILE FABRIC	
PRIORITY NA		
DESIGN NUMBER	324226-001	
CLASS	05-05	
BIBA APPARELS PRIVATE LIMITED, NO.4, GROUND FLOOR, DELSTAR PREMISES CHS NS PATKAR MARG, HUGES ROAD, KEMPS CORNER, MUMBAI – 400036 AND CORPORATE OFFICE AT 12TH & 13TH FLOOR CAPITAL CYBERSCAPE, SECTOR-59 GOLF COURSE EXTENSION ROAD,GURUGRAM-122102 HARYANA, INDIA.		
DATE OF REGISTRATION	02/12/2019	
TITLE	TEXTILE FABRIC	
PRIORITY NA		



DESIGN NUMBER	324227-001	
CLASS	05-05	
BIBA APPARELS PRIVATE LIMITED NO.4, GROUND FLOOR, DELSTAR PREMISES CHS NS PATKAR MARG, HUGES ROAD, KEMPS CORNER, MUMBAI – 400036 AND CORPORATE OFFICE AT 12TH & 13TH FLOOR CAPITAL CYBERSCAPE, SECTOR-59 GOLF COURSE EXTENSION ROAD,GURUGRAM-122102 HARYANA, INDIA.		
DATE OF REGISTRATION	02/12/2019	
TITLE	TEXTILE FABRIC	
PRIORITY NA		
DESIGN NUMBER	324228-001	
CLASS	05-05	
BIBA APPARELS PRIVATE LIMITED, NO.4, GROUND FLOOR, DELSTAR PREMISES CHS NS PATKAR MARG, HUGES ROAD, KEMPS CORNER, MUMBAI – 400036 AND CORPORATE OFFICE AT 12TH & 13TH FLOOR CAPITAL CYBERSCAPE, SECTOR-59 GOLF COURSE EXTENSION ROAD,GURUGRAM-122102 HARYANA, INDIA.		
DATE OF REGISTRATION	02/12/2019	
TITLE	TEXTILE FABRIC	
PRIORITY NA		
DESIGN NUMBER	324229-001	
CLASS	05-05	
BIBA APPARELS PRIVATE LIMITED, NO.4, GROUND FLOOR, DELSTAR PREMISES CHS NS PATKAR MARG, HUGES ROAD, KEMPS CORNER, MUMBAI – 400036 AND CORPORATE OFFICE AT 12TH & 13TH FLOOR CAPITAL CYBERSCAPE, SECTOR-59 GOLF COURSE EXTENSION ROAD,GURUGRAM-122102 HARYANA, INDIA.		
DATE OF REGISTRATION	02/12/2019	
TITLE	TEXTILE FABRIC	
PRIORITY NA		



DESIGN NUMBER	324233-001	
CLASS	05-05	
BIBA APPARELS PRIVATE LIMITED, NO.4, GROUND FLOOR, DELSTAR PREMISES CHS NS PATKAR MARG, HUGES ROAD, KEMPS CORNER, MUMBAI – 400036 AND CORPORATE OFFICE AT 12TH & 13TH FLOOR CAPITAL CYBERSCAPE, SECTOR-59 GOLF COURSE EXTENSION ROAD,GURUGRAM-122102 HARYANA, INDIA.		
DATE OF REGISTRATION	02/12/2019	
TITLE	TEXTILE FABRIC	
PRIORITY NA		
DESIGN NUMBER	324236-001	
CLASS	05-05	
BIBA APPARELS PRIVATE LIMITED NO.4, GROUND FLOOR, DELSTAR PREMISES CHS NS PATKAR MARG, HUGES ROAD, KEMPS CORNER, MUMBAI – 400036 AND CORPORATE OFFICE AT 12TH & 13TH FLOOR CAPITAL CYBERSCAPE, SECTOR-59 GOLF COURSE EXTENSION ROAD,GURUGRAM-122102 HARYANA, INDIA.		
DATE OF REGISTRATION	02/12/2019	
TITLE	TEXTILE FABRIC	
PRIORITY NA		
DESIGN NUMBER	324240-001	
CLASS	05-05	
BIBA APPARELS PRIVATE LIMITED, NO.4, GROUND FLOOR, DELSTAR PREMISES CHS NS PATKAR MARG, HUGES ROAD, KEMPS CORNER, MUMBAI – 400036 AND CORPORATE OFFICE AT 12TH & 13TH FLOOR CAPITAL CYBERSCAPE, SECTOR-59 GOLF COURSE EXTENSION ROAD,GURUGRAM-122102 HARYANA, INDIA.		
DATE OF REGISTRATION	02/12/2019	
TITLE	TEXTILE FABRIC	
PRIORITY NA		

DESIGN NUMBER	324245-001	
CLASS	05-05	
BIBA APPARELS PRIVATE LIMITED, NO.4, GROUND FLOOR, DELSTAR PREMISES CHS NS PATKAR MARG, HUGES ROAD, KEMPS CORNER, MUMBAI – 400036 AND CORPORATE OFFICE AT 12TH & 13TH FLOOR CAPITAL CYBERSCAPE, SECTOR-59 GOLF COURSE EXTENSION ROAD,GURUGRAM-122102 HARYANA, INDIA.		
DATE OF REGISTRATION	02/12/2019	
TITLE	TEXTILE FABRIC	
PRIORITY NA		
DESIGN NUMBER	324264-001	
CLASS	05-05	
BIBA APPARELS PRIVATE LIMITED, NO.4, GROUND FLOOR, DELSTAR PREMISES CHS NS PATKAR MARG, HUGES ROAD, KEMPS CORNER, MUMBAI – 400036 AND CORPORATE OFFICE AT 12TH & 13TH FLOOR CAPITAL CYBERSCAPE, SECTOR-59 GOLF COURSE EXTENSION ROAD,GURUGRAM-122102 HARYANA, INDIA.		
DATE OF REGISTRATION	02/12/2019	
TITLE	TEXTILE FABRIC	
PRIORITY NA		
DESIGN NUMBER	324276-001	
CLASS	05-05	
BIBA APPARELS PRIVATE LIMITED, NO.4, GROUND FLOOR, DELSTAR PREMISES CHS NS PATKAR MARG, HUGES ROAD, KEMPS CORNER, MUMBAI – 400036 AND CORPORATE OFFICE AT 12TH & 13TH FLOOR CAPITAL CYBERSCAPE, SECTOR-59 GOLF COURSE EXTENSION ROAD,GURUGRAM-122102 HARYANA, INDIA.		
DATE OF REGISTRATION	02/12/2019	
TITLE	TEXTILE FABRIC	
PRIORITY NA		

DESIGN NUMBER	324278-001	
CLASS	05-05	
BIBA APPARELS PRIVATE LIMITED, NO.4, GROUND FLOOR, DELSTAR PREMISES CHS NS PATKAR MARG, HUGES ROAD, KEMPS CORNER, MUMBAI – 400036 AND CORPORATE OFFICE AT 12TH & 13TH FLOOR CAPITAL CYBERSCAPE, SECTOR-59 GOLF COURSE EXTENSION ROAD,GURUGRAM-122102 HARYANA, INDIA.		
DATE OF REGISTRATION	02/12/2019	
TITLE	TEXTILE FABRIC	
PRIORITY NA		
DESIGN NUMBER	324279-001	
CLASS	05-05	
BIBA APPARELS PRIVATE LIMITED, NO.4, GROUND FLOOR, DELSTAR PREMISES CHS NS PATKAR MARG, HUGES ROAD, KEMPS CORNER, MUMBAI – 400036 AND CORPORATE OFFICE AT 12TH & 13TH FLOOR CAPITAL CYBERSCAPE, SECTOR-59 GOLF COURSE EXTENSION ROAD,GURUGRAM-122102 HARYANA, INDIA.		
DATE OF REGISTRATION	02/12/2019	
TITLE	TEXTILE FABRIC	
PRIORITY NA		
DESIGN NUMBER	324282-001	
CLASS	05-05	
BIBA APPARELS PRIVATE LIMITED, NO.4, GROUND FLOOR, DELSTAR PREMISES CHS NS PATKAR MARG, HUGES ROAD, KEMPS CORNER, MUMBAI – 400036 AND CORPORATE OFFICE AT 12TH & 13TH FLOOR CAPITAL CYBERSCAPE, SECTOR-59 GOLF COURSE EXTENSION ROAD,GURUGRAM-122102 HARYANA, INDIA.		
DATE OF REGISTRATION	02/12/2019	
TITLE	TEXTILE FABRIC	
PRIORITY NA		



DESIGN NUMBER	324283-001	
CLASS	05-05	
BIBA APPARELS PRIVATE LIMITED, NO.4, GROUND FLOOR, DELSTAR PREMISES CHS NS PATKAR MARG, HUGES ROAD, KEMPS CORNER, MUMBAI – 400036 AND CORPORATE OFFICE AT 12TH & 13TH FLOOR CAPITAL CYBERSCAPE, SECTOR-59 GOLF COURSE EXTENSION ROAD,GURUGRAM-122102 HARYANA, INDIA.		
DATE OF REGISTRATION	02/12/2019	
TITLE	TEXTILE FABRIC	
PRIORITY NA		
DESIGN NUMBER	324285-001	
CLASS	05-05	
BIBA APPARELS PRIVATE LIMITED, NO.4, GROUND FLOOR, DELSTAR PREMISES CHS NS PATKAR MARG, HUGES ROAD, KEMPS CORNER, MUMBAI – 400036 AND CORPORATE OFFICE AT 12TH & 13TH FLOOR CAPITAL CYBERSCAPE, SECTOR-59 GOLF COURSE EXTENSION ROAD,GURUGRAM-122102 HARYANA, INDIA.		
DATE OF REGISTRATION	02/12/2019	
TITLE	TEXTILE FABRIC	
PRIORITY NA		
DESIGN NUMBER	324292-001	
CLASS	05-05	
BIBA APPARELS PRIVATE LIMITED, NO.4, GROUND FLOOR, DELSTAR PREMISES CHS NS PATKAR MARG, HUGES ROAD, KEMPS CORNER, MUMBAI – 400036 AND CORPORATE OFFICE AT 12TH & 13TH FLOOR CAPITAL CYBERSCAPE, SECTOR-59 GOLF COURSE EXTENSION ROAD,GURUGRAM-122102 HARYANA, INDIA.		
DATE OF REGISTRATION	02/12/2019	
TITLE	TEXTILE FABRIC	
PRIORITY NA		



DESIGN NUMBER	324294-001	
CLASS	05-05	
BIBA APPARELS PRIVATE LIMITED, NO.4, GROUND FLOOR, DELSTAR PREMISES CHS NS PATKAR MARG, HUGES ROAD, KEMPS CORNER, MUMBAI – 400036 AND CORPORATE OFFICE AT 12TH & 13TH FLOOR CAPITAL CYBERSCAPE, SECTOR-59 GOLF COURSE EXTENSION ROAD,GURUGRAM-122102 HARYANA, INDIA.		
DATE OF REGISTRATION	02/12/2019	
TITLE	TEXTILE FABRIC	
PRIORITY NA		
DESIGN NUMBER	324296-001	
CLASS	05-05	
BIBA APPARELS PRIVATE LIMITED, NO.4, GROUND FLOOR, DELSTAR PREMISES CHS NS PATKAR MARG, HUGES ROAD, KEMPS CORNER, MUMBAI – 400036 AND CORPORATE OFFICE AT 12TH & 13TH FLOOR CAPITAL CYBERSCAPE, SECTOR-59 GOLF COURSE EXTENSION ROAD,GURUGRAM-122102 HARYANA, INDIA.		
DATE OF REGISTRATION	02/12/2019	
TITLE	TEXTILE FABRIC	
PRIORITY NA		
DESIGN NUMBER	324297-001	
CLASS	05-05	
BIBA APPARELS PRIVATE LIMITED, NO.4, GROUND FLOOR, DELSTAR PREMISES CHS NS PATKAR MARG, HUGES ROAD, KEMPS CORNER, MUMBAI – 400036 AND CORPORATE OFFICE AT 12TH & 13TH FLOOR CAPITAL CYBERSCAPE, SECTOR-59 GOLF COURSE EXTENSION ROAD,GURUGRAM-122102 HARYANA, INDIA.		
DATE OF REGISTRATION	02/12/2019	
TITLE	TEXTILE FABRIC	
PRIORITY NA		

DESIGN NUMBER	324302-001	
CLASS	05-05	
BIBA APPARELS PRIVATE LIMITED, NO.4, GROUND FLOOR, DELSTAR PREMISES CHS NS PATKAR MARG, HUGES ROAD, KEMPS CORNER, MUMBAI – 400036 AND CORPORATE OFFICE AT 12TH & 13TH FLOOR CAPITAL CYBERSCAPE, SECTOR-59 GOLF COURSE EXTENSION ROAD,GURUGRAM-122102 HARYANA, INDIA.		
DATE OF REGISTRATION	02/12/2019	
TITLE	TEXTILE FABRIC	
PRIORITY NA		
DESIGN NUMBER	324303-001	
CLASS	05-05	
BIBA APPARELS PRIVATE LIMITED, NO.4, GROUND FLOOR, DELSTAR PREMISES CHS NS PATKAR MARG, HUGES ROAD, KEMPS CORNER, MUMBAI – 400036 AND CORPORATE OFFICE AT 12TH & 13TH FLOOR CAPITAL CYBERSCAPE, SECTOR-59 GOLF COURSE EXTENSION ROAD,GURUGRAM-122102 HARYANA, INDIA.		
DATE OF REGISTRATION	02/12/2019	
TITLE	TEXTILE FABRIC	
PRIORITY NA		
DESIGN NUMBER	324306-001	
CLASS	05-05	
BIBA APPARELS PRIVATE LIMITED, NO.4, GROUND FLOOR, DELSTAR PREMISES CHS NS PATKAR MARG, HUGES ROAD, KEMPS CORNER, MUMBAI – 400036 AND CORPORATE OFFICE AT 12TH & 13TH FLOOR CAPITAL CYBERSCAPE, SECTOR-59 GOLF COURSE EXTENSION ROAD,GURUGRAM-122102 HARYANA, INDIA.		
DATE OF REGISTRATION	02/12/2019	
TITLE	TEXTILE FABRIC	
PRIORITY NA		

DESIGN NUMBER	324332-001	
CLASS	09-03	
NAYASA SUPERPLAST, SURVEY NO. 370/2 (7) KACHIGAM, NANI DAMAN, DAMAN – 396 210, (UNION TERRITORIES), INDIA, WHOSE PARTNERS ARE SACHIN SACHDEV & MANASI SACHDEV		
DATE OF REGISTRATION	03/12/2019	
TITLE	CONTAINER WITH LID	
PRIORITY NA		
DESIGN NUMBER	324420-001	
CLASS	08-06	
JAY SHREE KRUSHNA TRADING CO., 408, GIDC MANJUSAR (SAVLI), NEAR BOMBARDIAR CIRCLE, DIST. VADODARA – 391775, GUJARAT – INDIA, WHOSE PARTNERS ARE MANAL A. PARIKH AND SONAL A. PARIKH		
DATE OF REGISTRATION	05/12/2019	
TITLE	KNOB	
PRIORITY NA		
DESIGN NUMBER	324420-013	
CLASS	08-06	
JAY SHREE KRUSHNA TRADING CO., 408, GIDC MANJUSAR (SAVLI), NEAR BOMBARDIAR CIRCLE, DIST. VADODARA – 391775, GUJARAT – INDIA, WHOSE PARTNERS ARE MANAL A. PARIKH AND SONAL A. PARIKH		
DATE OF REGISTRATION	05/12/2019	
TITLE	HANDLE	
PRIORITY NA		



DESIGN NUMBER	307322	
CLASS	12-11	
P.K. MURUGESAN, #28, ARUL JOTHI LAYOUT, ANCHUGAM NAGAR, CHINNAVEDAMPATTI, COIMBATORE – 641049, STATE OF TAMIL NADU, INDIA		
DATE OF REGISTRATION	03/07/2018	
TITLE	WOODEN WHEEL FOR BICYCLE	
PRIORITY NA		
DESIGN NUMBER	317847-002	
CLASS	23-01	
LIVPURE PVT. LTD., 221, UDYOG VIHAR, PHASE - 1, GURGAON - 122016, HARYANA (INDIA)		
DATE OF REGISTRATION	20/05/2019	
TITLE	WATER PURIFIER	
PRIORITY NA		
DESIGN NUMBER	308381	
CLASS	07-02	
HAWKINS COOKERS LIMITED, MAKER TOWER F-101, CUFFE PARADE, P.O. BOX NO. 16083, MUMBAI- 400 005, MAHARASHTRA, INDIA		
DATE OF REGISTRATION	02/08/2018	
TITLE	PRESSURE COOKER	
PRIORITY NA		

DESIGN NUMBER	307915		
CLASS	14-02		
GEMÜ GEBR. MÜLLER APPARATEBAU GMBH & CO. KOMMANDITGESELLSCHAFT, FRITZ-MÜLLER-STRASSE 6-8,74653, INGELFINGEN, GERMANY			
DATE OF REGISTRATION	23/07/2018		
TITLE	RFID-READER		
PRIORITY			
PRIORITY NUMBER	DATE	COUNTRY	
005303427	08/06/2018	EUIPO	
DESIGN NUMBER	307483		
CLASS	02-04		
COLE HAAN LLC, 45 WEST 18TH STREET, THIRD FLOOR, NEW YORK, NY 10011, UNITED STATES OF AMERICA			
DATE OF REGISTRATION	06/07/2018		
TITLE	SHOE SOLE		
PRIORITY			
PRIORITY NUMBER	DATE	COUNTRY	
29/632,343	07/01/2018	U.S.A.	
DESIGN NUMBER	317982-001		
CLASS	09-01		
GODANI PLAST, 402-403, CHAITANYA CHS LTD, SIDDHARTH NAGAR, S. V. ROAD, OPP. RAM MANDIR ROAD, GOREGAON (W), MUMBAI-400 104, WHOSE PROPRIETORS ARE MISHRIMAL JIVRAJ GODANI, JINESH MISHRIMAL GODANI AND ASHISH MISHRIMAL GODANI.			
DATE OF REGISTRATION	22/05/2019		
TITLE	BOTTLE		
PRIORITY NA			

DESIGN NUMBER	318325-001		
CLASS	14-03		
SAMSUNG ELECTRONICS CO., LTD., 129, SAMSUNG-RO, YEONGTONG-GU, SUWON-SI, GYEONGGI-DO, 16677, REPUBLIC OF KOREA			
DATE OF REGISTRATION	31/05/2019		
TITLE	MOBILE PHONE		
PRIORITY			
PRIORITY NUMBER	DATE	COUNTRY	
30-2018-0059240	14/12/2018	REPUBLIC OF KOREA	
DESIGN NUMBER	318390-001		
CLASS	07-01		
GAURAV GOMBER, SIMRAN PLASTOWARE SHED NO.45 B AND 12, 7/3, ADARSH NURSERY, KIRARI ROAD, PREM NAGAR, NEW DELHI, DELHI- 110086			
DATE OF REGISTRATION	03/06/2019		
TITLE	JUG		
PRIORITY NA			
DESIGN NUMBER	318520-001		
CLASS	07-02		
HAWKINS COOKERS LIMITED, MAKER TOWER F-101, CUFFE PARADE, P.O. BOX NO. 16083, MUMBAI- 400005, MAHARASHTRA, INDIA			
DATE OF REGISTRATION	06/06/2019		
TITLE	PRESSURE COOKER		
PRIORITY NA			

DESIGN NUMBER	308869	
CLASS	04-01	
FREUDENBERG GALA HOUSEHOLD PRODUCT PRIVATE LIMITED, O2 GALLERIA, B - 902/903/904, PLOT NO. 23 / 24, MINERVA INDUSTRIAL ESTATE, OFF LBS MARG, NEAR ASHA NAGAR, MULUND (WEST),MUMBAI – 400 080, MAHARASHTRA, INDIA.		
DATE OF REGISTRATION	18/08/2018	
TITLE	BROOM	
PRIORITY NA		
DESIGN NUMBER	310349	
CLASS	09-03	
JOYO PLASTICS, 104, 1ST FLOOR, JAY ANTRIKSH, MAROL MAKWANA ROAD, ANDHERI-KURLA ROAD, ANDHERI (E), MUMBAI - 400 059		
DATE OF REGISTRATION	27/09/2018	
TITLE	CONTAINER	
PRIORITY NA		
DESIGN NUMBER	298381	
CLASS	22-01	
IBRAHEEM RAZA KHAN, H.NO.-565/6 INDRAYANI DARSHAN, DEHUROAD, PUNE-412101, INDIA		
DATE OF REGISTRATION	13/10/2017	
TITLE	SPORTS AIR RIFLE TRIGGER	
PRIORITY NA		



DESIGN NUMBER	320453-001		
CLASS	12-11		
BAYERISCHE MOTOREN WERKE AKTIENGESELLSCHAFT, PETUELRING 130, 80809, MUENCHEN, GERMANY			
DATE OF REGISTRATION	06/08/2019		
TITLE	MOTORCYCLE		
PRIORITY			
PRIORITY NUMBER	DATE	COUNTRY	
DE 402019100164.6	06/02/2019	GERMANY	
DESIGN NUMBER	310593		
CLASS	06-01		
JOYO PLASTICS, JOYO PLASTICS 103/104, JAY ANTARIKSH, MAROL MAKWANA ROAD, ANDHERI KURLA ROAD, ANDHERI (EAST), MUMBAI, MAHARASHTRA, 400059.			
DATE OF REGISTRATION	03/10/2018		
TITLE	STOOL		
PRIORITY NA			
DESIGN NUMBER	310643		
CLASS	02-01		
SWAMI VIVEKANAND SUBHARTI UNIVERSITY, NH-58, DELHI-HARIDWAR, BYPASS ROAD, MEERUT -250005, UTTAR PRADESH			
DATE OF REGISTRATION	05/10/2018		
TITLE	POST CESAREAN ABDOMINAL BELT FOR MOTHER		
PRIORITY NA			

DESIGN NUMBER	320719-001		
CLASS	02-04		
DADU RUBBER PRODUCTS, 31/13/3/2,13/5,2 VILLAGE NATHPUR, DISTT. SONPAT, HARYANA, INDIA, WHOSE PARTNERS ARE SURESH SHARMA AND MEENA SHARMA			
DATE OF REGISTRATION	16/08/2019		
TITLE	INSOLE MATERIAL FOR FOOTWEAR		
PRIORITY NA			
DESIGN NUMBER	320859-001		
CLASS	13-03		
HAVELLS INDIA LIMITED, 904, 9TH FLOOR, SURYA KIRAN BUILDING, K.G. MARG, CONNAUGHT PLACE, NEW DELHI-110001, INDIA			
DATE OF REGISTRATION	20/08/2019		
TITLE	EXTENSION CORD		
PRIORITY NA			
DESIGN NUMBER	320886-001		
CLASS	09-01		
STRAUSS GROUP LTD., YANAI PARK, 49 HASIVIM STREET, P.O. BOX 194, 4959504 PETACH-TIKVA, ISRAEL.			
DATE OF REGISTRATION	21/08/2019		
TITLE	COLLAPSED BOTTLE		
PRIORITY			
PRIORITY NUMBER	DATE	COUNTRY	
63424	25/02/2019	ISRAEL	

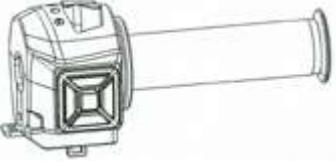

DESIGN NUMBER	320908-001		
CLASS	02-04		
RELAXO FOOTWEARS LIMITED, AGGARWAL CITY SQUARE, PLOT NO. 10, MANGLAM PLACE, DISTRICT CENTRE, SECTOR – 3, ROHINI, DELHI 110085			
DATE OF REGISTRATION	21/08/2019		
TITLE	FOOTWEAR		
PRIORITY NA			
DESIGN NUMBER	320910-001		
CLASS	02-04		
RELAXO FOOTWEARS LIMITED, AGGARWAL CITY SQUARE, PLOT NO. 10, MANGLAM PLACE, DISTRICT CENTRE, SECTOR – 3, ROHINI, DELHI 110085			
DATE OF REGISTRATION	21/08/2019		
TITLE	FOOTWEAR		
PRIORITY NA			
DESIGN NUMBER	311736		
CLASS	15-99		
BUSS AG, HOHENRAINSTRASSE 10, 4133 PRATTELN, SWITZERLAND			
DATE OF REGISTRATION	02/11/2018		
TITLE	SCREW SHAFT ELEMENT		
PRIORITY			
PRIORITY NUMBER	DATE	COUNTRY	
005258472-0008	04/05/2018	EUIPO	

DESIGN NUMBER	311740		
CLASS	15-99		
BUSS AG, HOHENRAINSTRASSE 10, 4133 PRATTELN, SWITZERLAND			
DATE OF REGISTRATION	02/11/2018		
TITLE	SCREW SHAFT ELEMENT		
PRIORITY			
PRIORITY NUMBER	DATE	COUNTRY	
005258811-0008	04/05/2018	EUIPO	
DESIGN NUMBER	312021		
CLASS	14-02		
MICROSOFT CORPORATION, ONE MICROSOFT WAY, REDMOND, WA 98052-5321, U.S.A.			
DATE OF REGISTRATION	15/11/2018		
TITLE	COMPUTER AND DOCKING MOUNT		
PRIORITY			
PRIORITY NUMBER	DATE	COUNTRY	
29/647800	15/05/2018	U.S.A.	
DESIGN NUMBER	321302-001		
CLASS	09-03		
NUTRISET, BOIS RICARD F-76770 MALAUNAY, FRANCE			
DATE OF REGISTRATION	03/09/2019		
TITLE	CARDBOARD CARTON FOR PACKAGING		
PRIORITY			
PRIORITY NUMBER	DATE	COUNTRY	
006588166-0002	20/06/2019	EUIPO	



DESIGN NUMBER	321365-001		
CLASS	14-03		
BEIJING XIAOMI MOBILE SOFTWARE CO., LTD., ROOM 01, FLOOR 9, RAINBOW CITY SHOPPING MALL?OF CHINA RESOURCES, NO. 68, QINGHE MIDDLE STREET, HAIDIAN DISTRICT, BEIJING 100085, CHINA			
DATE OF REGISTRATION	05/09/2019		
TITLE	MOBILE PHONE		
PRIORITY			
PRIORITY NUMBER	DATE	COUNTRY	
201930090504.0	06/03/2019	CHINA	
DESIGN NUMBER	321413-003		
CLASS	24-02		
ETHICON LLC, # 475 STREET C, SUITE 401 LOS FRAILES INDUSTRIAL PARK GUAYNABO, PUERTO RICO 00969			
DATE OF REGISTRATION	06/09/2019		
TITLE	SURGICAL STAPLER WASHER		
PRIORITY			
PRIORITY NUMBER	DATE	COUNTRY	
29/682,822	08/03/2019	U.S.A.	
DESIGN NUMBER	321453-001		
CLASS	12-16		
NAPINO AUTO & ELECTRONICS LTD, SEC-3 PLOT NO. 7, SECTOR 3, IMT MANESAR, GURGAON-122050, HARYANA INDIA			
DATE OF REGISTRATION	09/09/2019		
TITLE	RIGHT HAND SWITCH CONSOLE INTEGRATED THROTTLE		
PRIORITY NA			

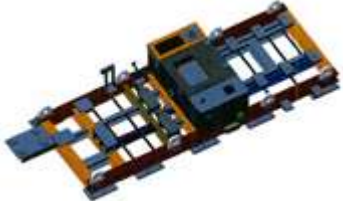

DESIGN NUMBER	321482-001		
CLASS	09-01		
PUIG FRANCE, 65-67 AVENUE DES CHAMPS ELYSÉES 75008 PARIS, FRANCE			
DATE OF REGISTRATION	10/09/2019		
TITLE	PERFUME CONTAINER		
PRIORITY			
PRIORITY NUMBER	DATE	COUNTRY	
006301230-0001	11/03/2019	EUIPO	
DESIGN NUMBER	321512-004		
CLASS	07-06		
MA DESIGN INDIA PRIVATE LIMITED, A-41, SECTOR-80, PHASE-II, NOIDA-201305,U.P., INDIA			
DATE OF REGISTRATION	11/09/2019		
TITLE	CONTAINER (FOR SUGAR)		
PRIORITY NA			
DESIGN NUMBER	323545-001		
CLASS	02-04		
RELAXO FOOTWEARS LIMITED, AGGARWAL CITY SQUARE, PLOT NO. 10, MANGLAM PLACE, DISTRICT CENTRE, SECTOR – 3, ROHINI, DELHI 110085			
DATE OF REGISTRATION	11/11/2019		
TITLE	FOOTWEAR		
PRIORITY NA			



DESIGN NUMBER	323551-001	
CLASS	02-04	
RELAXO FOOTWEARS LIMITED, AGGARWAL CITY SQUARE, PLOT NO. 10, MANGLAM PLACE, DISTRICT CENTRE, SECTOR – 3, ROHINI, DELHI 110085		
DATE OF REGISTRATION	11/11/2019	
TITLE	FOOTWEAR	
PRIORITY NA		
DESIGN NUMBER	323620-001	
CLASS	15-01	
TRIVENI TURBINE LIMITED, TRIVENI TURBINE LIMITED, 12-A, PEENYA INDUSTRIAL AREA, BANGALORE 560058.		
DATE OF REGISTRATION	13/11/2019	
TITLE	BLADE SHIELD OF A STEAM TURBINE	
PRIORITY NA		
DESIGN NUMBER	323689-001	
CLASS	02-02	
SABYASACHI COUTURE, 86C, JATIN DAS ROAD, KOLKATA-700029, STATE OF WEST BENGAL, WHOSE PARTNERS ARE MR. SUKUMAR MUKHERJEE AND MR. SABYASACHI MUKHERJEE.		
DATE OF REGISTRATION	15/11/2019	
TITLE	SAREE AND BLOUSE (SET)	
PRIORITY NA		



DESIGN NUMBER	323691-001	
CLASS	02-02	
SABYASACHI COUTURE, 86C, JATIN DAS ROAD, KOLKATA-700029, STATE OF WEST BENGAL, WHOSE PARTNERS ARE MR. SUKUMAR MUKHERJEE AND MR. SABYASACHI MUKHERJEE.		
DATE OF REGISTRATION	15/11/2019	
TITLE	SAREE AND BLOUSE (SET)	
PRIORITY NA		
DESIGN NUMBER	323745-001	
CLASS	15-07	
ESBEE ELECTRO-TECH LLP, J-159, M.I.D.C., BHOSARI, PUNE-411029, MAHARASHTRA		
DATE OF REGISTRATION	18/11/2019	
TITLE	LED BULB SOCKET FOR REFRIGERATOR	
PRIORITY NA		
DESIGN NUMBER	321865-001	
CLASS	15-01	
TRIVENI TURBINE LIMITED, 12-A, PEENYA INDUSTRIAL AREA, BANGALORE, KARNATAKA - 560058		
DATE OF REGISTRATION	21/09/2019	
TITLE	BASE PLATE OF A STEAM TURBINE	
PRIORITY NA		

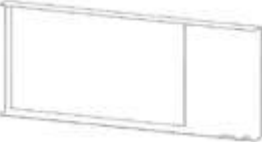

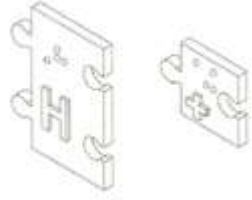
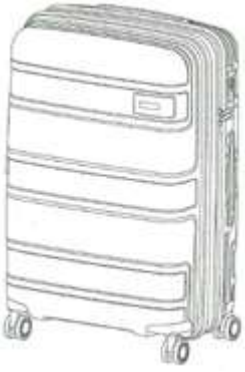
DESIGN NUMBER	321904-001		
CLASS	24-01		
ASHOK YADAVRAO KSHIRSAGAR, MEDICAL DIRECTOR OFFICE, KRISHNA MEDICAL COLLEGE AND HOSPITAL, NEAR DHEBEWADI ROAD, MALKAPUR, TAL-KARAD, DIST-SATARA, MAHARASHTRA. 415539			
DATE OF REGISTRATION	23/09/2019		
TITLE	SELF - RETAINING THYROID RETRACTOR		
PRIORITY NA			
DESIGN NUMBER	321905-001		
CLASS	26-06		
MINDA INDUSTRIES LTD., 4W LIGHTING DIVISION, VILL. NAHARPUR, KASAN, P.O. NAKHROLA, MANESAR, DISTT. GURGAON, HARYANA-122004, INDIA			
DATE OF REGISTRATION	23/09/2019		
TITLE	INDICATOR FOR VEHICLE		
PRIORITY NA			
DESIGN NUMBER	321914-001		
CLASS	12-11		
HONDA MOTOR CO., LTD., 1-1, MINAMI-AOYAMA 2-CHOME, MINATO-KU, TOKYO, 107-8556 JAPAN			
DATE OF REGISTRATION	23/09/2019		
TITLE	FRONT SIDE COWL FOR A MOTORCYCLE		
PRIORITY			
PRIORITY NUMBER	DATE	COUNTRY	
2019-006790	29/03/2019	JAPAN	



DESIGN NUMBER	321952-001			
CLASS	13-02			
SAMSUNG ELECTRONICS CO., LTD., 129, SAMSUNG-RO, YEONGTONG-GU, SUWON-SI, GYEONGGI-DO, 16677, REPUBLIC OF KOREA				
DATE OF REGISTRATION	24/09/2019			
TITLE	WIRELESS CHARGER FOR A MOBILE PHONE			
PRIORITY				
PRIORITY NUMBER	DATE	COUNTRY		
30-2019-0033933	16/07/2019	REPUBLIC OF KOREA		
DESIGN NUMBER	322089-001			
CLASS	24-02			
KONINKLIJKE PHILIPS N.V., HIGH TECH CAMPUS 5, 5656 AE EINDHOVEN, THE NETHERLANDS.				
DATE OF REGISTRATION	27/09/2019			
TITLE	BREAST PUMP FUNNEL			
PRIORITY				
PRIORITY NUMBER	DATE	COUNTRY		
006477592-0003	17/05/2019	EUIPO		
DESIGN NUMBER	322137-001			
CLASS	12-16			
M/S STEEL STRIPS WHEELS LTD, S.C.O. 49-50, SECTOR-26, MADHYA MARG, CHANDIGARH- 160 019.				
DATE OF REGISTRATION	27/09/2019			
TITLE	WHEEL DISC			
PRIORITY NA				

DESIGN NUMBER	322148-001		
CLASS	23-04		
FUMEX AKTIEBOLAG, VERKSTADSVÄGEN 2, SE-931 61 SKELLEFTEÅ, SWEDEN.			
DATE OF REGISTRATION	28/09/2019		
TITLE	VENTILATION HOSE		
PRIORITY			
PRIORITY NUMBER	DATE	COUNTRY	
006356093-0003	29/03/2019	EUIPO	
DESIGN NUMBER	330158-002		
CLASS	15-07		
1. PUSHPENDRA SINGH, ASSOCIATE PROFESSOR, JK LAKSHMIPAT UNIVERSITY, JAIPUR (RAJ.) INDIA 2. AKASH TALWARIYA, ASSISTANT PROFESSOR, DEPARTMENT OF ELECTRICAL ENGINEERING, JECRC UNIVERSITY, JAIPUR (RAJ), INDIA 3. DEEPAK SHARMA, ASSISTANT PROFESSOR, ARYA INSTITUTE OF ENGINEERING AND TECHNOLOGY, KUKAS, JAIPUR (RAJ.) 4. S. K. SHARMA, ASSISTANT PROFESSOR, DEPTT. OF ELECTRICAL ENGINEERING, RAJASTHAN TECHNICAL UNIVERSITY, KOTA (RAJ.) INDIA , ET AL.			
DATE OF REGISTRATION	18/06/2020		
TITLE	LIQUID COOLING ROD		
PRIORITY NA			
DESIGN NUMBER	330243-001		
CLASS	14-03		
SAMSUNG ELECTRONICS CO., LTD., 129, SAMSUNG-RO, YEONGTONG-GU, SUWON-SI, GYEONGGI-DO 16677, REPUBLIC OF KOREA			
DATE OF REGISTRATION	19/06/2020		
TITLE	TELEVISION		
PRIORITY			
PRIORITY NUMBER	DATE	COUNTRY	
30-2019-0063467	27/12/2019	REPUBLIC OF KOREA	

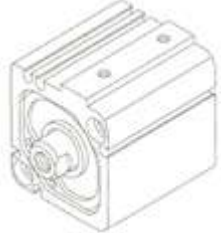

DESIGN NUMBER	323772-001		
CLASS	21-01		
1.DR. B. S. BALAJI, LAB NO. 005, SCHOOL OF BIOTECHNOLOGY, JAWAHARLAL NEHRU UNIVERSITY, NEW DELHI-110067 2. ISHU SINGHAL, LAB NO. 005, SCHOOL OF BIOTECHNOLOGY, JAWAHARLAL NEHRU UNIVERSITY, NEW DELHI-110067			
DATE OF REGISTRATION	19/11/2019		
TITLE	TEACHING GAME SET		
PRIORITY NA			
DESIGN NUMBER	324076-001		
CLASS	03-01		
SAMSONITE IP HOLDINGS S.À R.L., 13-15 AVENUE DE LA LIBERTÉ, L-1931 LUXEMBOURG, LUXEMBOURG			
DATE OF REGISTRATION	28/11/2019		
TITLE	LUGGAGE		
PRIORITY			
PRIORITY NUMBER	DATE	COUNTRY	
1913775.9M007	30/05/2019	HONGKONG	
DESIGN NUMBER	321586-001		
CLASS	09-01		
JB PERFUMES PRIVATE LIMITED, 52, SAI ROAD, BADDI-173 205, DISTT. SOLAN, HIMACHAL PRADESH (INDIA)			
DATE OF REGISTRATION	12/09/2019		
TITLE	BOTTLE		
PRIORITY NA			

DESIGN NUMBER	321587-001	
CLASS	24-02	
1. KAMALA KANT PARASHAR, PARASHAR BHAWAN, DILWARI PARA, BARI, DHOLPUR, RAJASTHAN, 328021, INDIA 2. DIPTI SHUKLA, 73/11, NEAR SBI, VIVEK NAGAR, SIDHAULI, SITAPUR UTTAR PRADESH, INDIA, 261303		
DATE OF REGISTRATION	13/09/2019	
TITLE	VAGINAL REFLECTOR	
PRIORITY NA		
DESIGN NUMBER	321603-001	
CLASS	23-01	
VAYUJAL TECHNOLOGIES PRIVATE LIMITED, IIT MADRAS RESEARCH PARK, 01FA, FIRST FLOOR, KANAGAM ROAD, TARAMANI CHENNAI-600113, INDIA		
DATE OF REGISTRATION	13/09/2019	
TITLE	ATMOSPHERIC WATER GENERATOR	
PRIORITY NA		
DESIGN NUMBER	321629-001	
CLASS	02-04	
SABYASACHI COUTURE, 86C, JATIN DAS ROAD, KOLKATA-700029, STATE OF WEST BENGAL, WHOSE PARTNERS ARE MR. SUKUMAR MUKHERJEE AND MR. SABYASACHI MUKHERJEE.		
DATE OF REGISTRATION	14/09/2019	
TITLE	SHOE	
PRIORITY NA		

DESIGN NUMBER	321645-001		
CLASS	15-04		
SUNIL KUMAR SHARMA, 26-A, BASEMENT, KARTARPURA INDUSTRIAL AREA, BEHIND GAYATRI PUBLIC SCHOOL, NANDPURI, JAIPUR, INDIA			
DATE OF REGISTRATION	14/09/2019		
TITLE	OFC BLOWING MACHINE FOR CONSTRUCTION		
PRIORITY NA			
DESIGN NUMBER	321650-001		
CLASS	15-99		
SMC CORPORATION, 14-1, SOTOKANDA 4-CHOME, CHIYODA-KU, TOKYO 101-0021, JAPAN.			
DATE OF REGISTRATION	16/09/2019		
TITLE	FLUID PRESSURE CYLINDER		
PRIORITY			
PRIORITY NUMBER	DATE	COUNTRY	
201930137122.9	29/03/2019	CHINA	
DESIGN NUMBER	321699-001		
CLASS	23-01		
BEIJING XIAOMI MOBILE SOFTWARE CO., LTD., ROOM 01, FLOOR 9, RAINBOW CITY SHOPPING MALL II OF CHINA RESOURCES, NO. 68, QINGHE MIDDLE STREET, HAIDIAN DISTRICT, BEIJING 100085, CHINA			
DATE OF REGISTRATION	17/09/2019		
TITLE	WATER PURIFIER		
PRIORITY			
PRIORITY NUMBER	DATE	COUNTRY	
201930110367.2	18/03/2019	CHINA	



DESIGN NUMBER	321814-001		
CLASS	15-09		
INDIAN INSTITUTE OF TECHNOLOGY, KHARAGPUR, SPONSORED RESEARCH & INDUSTRIAL CONSULTANCY, INDIAN INSTITUTE OF TECHNOLOGY, KHARAGPUR, KHARAGPUR - 721302, WEST BENGAL, INDIA			
DATE OF REGISTRATION	19/09/2019		
TITLE	SEMI-AUTOMATIC METALLOGRAPHIC SAMPLE POLISHING ARM		
PRIORITY NA			
DESIGN NUMBER	321836-001		
CLASS	28-03		
KONINKLIJKE PHILIPS N.V., HIGH TECH CAMPUS 5, 5656 AE EINDHOVEN, THE NETHERLANDS.			
DATE OF REGISTRATION	20/09/2019		
TITLE	SHAVER		
PRIORITY			
PRIORITY NUMBER	DATE	COUNTRY	
006316832	21/03/2019	EUIPO	
DESIGN NUMBER	330035-001		
CLASS	28-03		
R. VARALAKSHMI, SOEL, TNDALU, F2, D.J. RESIDENCY, NO. 2, RAMAN STREET, M.C. NAGAR, HASTHINAPURAM, CHENNAI – 600 064			
DATE OF REGISTRATION	16/06/2020		
TITLE	NAIL CLIPPER WITH HOLDER		
PRIORITY NA			



DESIGN NUMBER	313016-001	
CLASS	02-04	
SKECHERS U.S.A., INC. II, 228 MANHATTAN BEACH BLVD., MANHATTAN BEACH, CA 90266, U.S.A		
DATE OF REGISTRATION	12/12/2018	
TITLE	SHOE	
PRIORITY NA		
DESIGN NUMBER	313020-001	
CLASS	02-04	
SKECHERS U.S.A., INC. II, 228 MANHATTAN BEACH BLVD., MANHATTAN BEACH, CA 90266, U.S.A		
DATE OF REGISTRATION	12/12/2018	
TITLE	SHOE	
PRIORITY NA		
DESIGN NUMBER	313092-001	
CLASS	09-01	
EMAMI LIMITED, 'EMAMI TOWER', 687 ANANDAPUR, EM BYPASS, KOLKATA 700 017, WEST BENGAL, INDIA.		
DATE OF REGISTRATION	14/12/2018	
TITLE	BOTTLE WITH HEXAGONAL CAP	
PRIORITY NA		



DESIGN NUMBER	322901-001		
CLASS	12-08		
HONDA MOTOR CO., LTD., 1-1, MINAMI-AOYAMA 2-CHOME, MINATO-KU, TOKYO, 107-8556 JAPAN			
DATE OF REGISTRATION	23/10/2019		
TITLE	CAR		
PRIORITY			
PRIORITY NUMBER	DATE	COUNTRY	
2019-009519	26/04/2019	JAPAN	
DESIGN NUMBER	322920-001		
CLASS	12-16		
RENAULT S.A.S, 13-15 QUAI LE GALLO 92100 BOULOGNE BILLANCOURT FRANCE			
DATE OF REGISTRATION	23/10/2019		
TITLE	LEFT TRUNK DOOR FOR VEHICLE		
PRIORITY NA			
DESIGN NUMBER	322927-001		
CLASS	12-16		
RENAULT S.A.S, 13-15 QUAI LE GALLO 92100 BOULOGNE BILLANCOURT FRANCE			
DATE OF REGISTRATION	23/10/2019		
TITLE	BACK LEFT SIDE CUSTODIC WINDOW FOR VEHICLE		
PRIORITY NA			

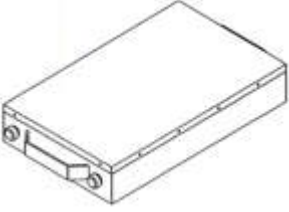

DESIGN NUMBER	322933-001	
CLASS	12-16	
RENAULT S.A.S, 13-15 QUAI LE GALLO 92100 BOULOGNE BILLANCOURT FRANCE		
DATE OF REGISTRATION	23/10/2019	
TITLE	FRONT BUMPER FOR VEHICLE	
PRIORITY NA		
DESIGN NUMBER	323010-001	
CLASS	12-16	
TATA TOYO RADIATOR LTD., SURVEY NO. 235/245, VILLAGE HINJAWADI, TALUKA MULSHI, PUNE - 411057, MAHARASHTRA, INDIA		
DATE OF REGISTRATION	25/10/2019	
TITLE	DEAERATION TANK FOR VEHICLE	
PRIORITY NA		
DESIGN NUMBER	323018-001	
CLASS	13-03	
ELMEX CONTROLS PVT. LTD, 12, GIDC ESTATE, MAKARPURA ROAD, VADODARA - 390001, GUJARAT, INDIA.		
DATE OF REGISTRATION	25/10/2019	
TITLE	ELECTRIC TERMINAL	
PRIORITY NA		



DESIGN NUMBER	323064-009		
CLASS	14-03		
RELIANCE JIO INFOCOMM LIMITED, OFFICE-101, SAFFRON, NR. CENTRE POINT, PANCHWATI 5 RASTA, AMBAWADI, AHMEDABAD-380006, GUJARAT, INDIA			
DATE OF REGISTRATION	29/10/2019		
TITLE	INTERCOMMUNICATION DEVICE		
PRIORITY NA			
DESIGN NUMBER	323078-001		
CLASS	14-02		
BEIJING XIAOMI MOBILE SOFTWARE CO., LTD., ROOM 01, FLOOR 9, RAINBOW CITY SHOPPING MALL II OF CHINA RESOURCES, NO. 68, QINGHE MIDDLE STREET, HAIDIAN DISTRICT, BEIJING 100085, CHINA			
DATE OF REGISTRATION	29/10/2019		
TITLE	MEMORY CARD		
PRIORITY			
PRIORITY NUMBER	DATE	COUNTRY	
201930210342.X	30/04/2019	CHINA	
DESIGN NUMBER	303515		
CLASS	23-04		
PARESH B PRAJAPATI, 466/1, OPP. CHAMUNDA NAGAR, SARKHEJ DHOLKA ROAD, SARKHEJ, AHMEDABAD-382210, GUJARAT, INDIA			
DATE OF REGISTRATION	13/03/2018		
TITLE	AIR CONDITIONING DUCT		
PRIORITY NA			

DESIGN NUMBER	315403-001		
CLASS	06-03		
HANGZHOU SICCO ART-TECHNOLOGY CO., LTD., ROOM 501-3, UNIT 1, BUILDING 18, NO. 1218 WEST WENYI ROAD, CANGQIAN, YUHANG DISTRICT, HANGZHOU, ZHEJIANG, 310012, CHINA.			
DATE OF REGISTRATION	06/03/2019		
TITLE	CORNER TABLE		
PRIORITY			
PRIORITY NUMBER	DATE	COUNTRY	
201830501975.1	07/09/2018	CHINA	
DESIGN NUMBER	315441-001		
CLASS	08-08		
A. RAYMOND ET CIE, 113 COURS BERRIAT, 38000 GRENOBLE, FRANCE			
DATE OF REGISTRATION	06/03/2019		
TITLE	FIXING CLIP		
PRIORITY NA			
DESIGN NUMBER	315460-002		
CLASS	24-02		
MEGADYNE MEDICAL PRODUCTS, INC., 11506 SOUTH STATE STREET, DRAPER, UTAH, 84020, UNITED STATES OF AMERICA			
DATE OF REGISTRATION	07/03/2019		
TITLE	UNIVERSAL CONNECTOR		
PRIORITY			
PRIORITY NUMBER	DATE	COUNTRY	
29/664,475	25/09/2018	U.S.A.	



DESIGN NUMBER	325089-001	
CLASS	09-03	
PUR ENERGY PRIVATE LIMITED, H. NO 10-38/2, SURVEY NO 424/AA3 BESIDE ARYA COLLEGE OF PHARMACY NEAR IIT HYDERABAD KANDI VILLAGE SANGAREDDY - 502285, INDIA		
DATE OF REGISTRATION	27/12/2019	
TITLE	A CASE FOR ENERGY STORAGE SYSTEMS	
PRIORITY NA		
DESIGN NUMBER	325215-001	
CLASS	02-02	
SABYASACHI COUTURE, 86C, JATIN DAS ROAD, KOLKATA-700029, STATE OF WEST BENGAL, WHOSE PARTNERS ARE MR. SUKUMAR MUKHERJEE AND MR. SABYASACHI MUKHERJEE.		
DATE OF REGISTRATION	30/12/2019	
TITLE	GARMENT (SET)	
PRIORITY NA		
DESIGN NUMBER	330925-001	
CLASS	29-02	
NILKAMAL LIMITED, PLOT NO.77/78, STREET NO.14, M.I.D.C., ANDHERI(EAST), MUMBAI 400093		
DATE OF REGISTRATION	09/07/2020	
TITLE	TRAVEL GUARD	
PRIORITY NA		

DESIGN NUMBER	312329		
CLASS	12-11		
HERO CYCLES LIMITED, HERO NAGAR, G.T. ROAD, LUDHIANA – 141003 (PUNJAB), INDIA			
DATE OF REGISTRATION	22/11/2018		
TITLE	BACK REST OF BICYCLE		
PRIORITY NA			
DESIGN NUMBER	322184-001		
CLASS	15-04		
HAMM AG, HAMMSTRASSE 1, 95643 TIRSCHENREUTH, GERMANY			
DATE OF REGISTRATION	30/09/2019		
TITLE	ROOF OF DRIVER'S CAB OF ROAD MAKING MACHINE		
PRIORITY			
PRIORITY NUMBER	DATE	COUNTRY	
006369245	04/04/2019	EUIPO	
DESIGN NUMBER	322191-001		
CLASS	09-01		
TRODAT GMBH, LINZER STRASSE 156 4600 WELS, AUSTRIA			
DATE OF REGISTRATION	30/09/2019		
TITLE	BOTTLE		
PRIORITY			
PRIORITY NUMBER	DATE	COUNTRY	
006367298-0003	03/04/2019	EUIPO	

DESIGN NUMBER	322193-001		
CLASS	14-03		
BEIJING XIAOMI MOBILE SOFTWARE CO., LTD., ROOM 01, FLOOR 9, RAINBOW CITY SHOPPING MALL II OF CHINA RESOURCES, NO. 68, QINGHE MIDDLE STREET, HAIDIAN DISTRICT, BEIJING 100085, CHINA.			
DATE OF REGISTRATION	30/09/2019		
TITLE	TELEVISION SCREEN		
PRIORITY			
PRIORITY NUMBER	DATE	COUNTRY	
201930155149.0	08/04/2019	CHINA	
DESIGN NUMBER	322213-001		
CLASS	06-01		
SAT INDUSTRIES LIMITED, E-260-261, MIA UDAIPUR RAJASTHAN			
DATE OF REGISTRATION	01/10/2019		
TITLE	CHAIR		
PRIORITY NA			
DESIGN NUMBER	322226-001		
CLASS	26-05		
FLOS S.P.A., VIA A. FAINI, 2, I-25073 BOVEZZO, BRESCIA, ITALY			
DATE OF REGISTRATION	01/10/2019		
TITLE	CEILING LIGHT		
PRIORITY			
PRIORITY NUMBER	DATE	COUNTRY	
402019000000619	02/04/2019	ITALY	



DESIGN NUMBER	322230-001		
CLASS	04-02		
1. BALWANT RAI, VILL - BHANGU, P.O. - SAHUWALA 1, DISTRICT - SIRSA (HARYANA), INDIA 2. JASDEEP KAUR, VILL - BHANGU, P.O. - SAHUWALA 1, DISTRICT - SIRSA (HARYANA), INDIA			
DATE OF REGISTRATION	01/10/2019		
TITLE	TOOTH BRUSH		
PRIORITY NA			
DESIGN NUMBER	322251-001		
CLASS	15-04		
NORMET OY, AHMOLANTIE 6, 74510 IISALMI, FINLAND.			
DATE OF REGISTRATION	03/10/2019		
TITLE	COCKPIT FOR CONSTRUCTION AND MINING MACHINERIES		
PRIORITY			
PRIORITY NUMBER	DATE	COUNTRY	
006371134-0002	05/04/2019	EUIPO	
DESIGN NUMBER	322291-001		
CLASS	23-01		
CHAIRMAN, DEFENCE RESEARCH & DEVELOPMENT ORGANISATION, MINISTRY OF DEFENCE, GOVERNMENT OF INDIA, ROOM NO. 348, B-WING, DRDO BHAWAN, RAJAJI MARG, NEW DELHI-110105, INDIA.			
DATE OF REGISTRATION	04/10/2019		
TITLE	DEFLUORIDATION UNIT		
PRIORITY NA			

DESIGN NUMBER	322299-001	
CLASS	14-03	
BEIJING XIAOMI MOBILE SOFTWARE CO., LTD., RM 01, 9F, RAINBOW CITY SHOPPING MALL II OF CHINA RESOURCES, 68 QINGHE MIDDLE ST, HAIDIAN DIST BEIJING 100085		
DATE OF REGISTRATION	04/10/2019	
TITLE	TELEVISION APPARATUS	
PRIORITY NA		
DESIGN NUMBER	322306-001	
CLASS	07-02	
BHAMA ENTERPRISES (INDIA) PRIVATE LIMITED, PLOT NO.51-A, SECTOR -A, SANWER ROAD INDUSTRIAL ESTATE, INDORE-452015, M.P., INDIA.		
DATE OF REGISTRATION	04/10/2019	
TITLE	CASSEROLE	
PRIORITY NA		
DESIGN NUMBER	322380-001	
CLASS	21-01	
PARAG JAIN, B N-29, EAST SHALIMAR BAGH, DELHI-110088, INDIA		
DATE OF REGISTRATION	09/10/2019	
TITLE	TOY CAR	
PRIORITY NA		

DESIGN NUMBER	322384-002		
CLASS	23-04		
M/S. NOVAMAX INDUSTRIES LLP., B-002/38, SITE-B, SURAJPUR INDUSTRIAL AREA, GREATER NOIDA, GUATAM BUDH NAGAR, UTTAR PRADESH-201310, INDIA WHOSE PARTNERS ARE HARSH GOYAL, PRAVEEN KUMAR, AJAY KUMAR GARG, HARSHIT AGGARWAL, ARVIND KUMAR, PUNEET GOYAL, GANESH KUMAR GARG			
DATE OF REGISTRATION	09/10/2019		
TITLE	COOLER		
PRIORITY NA			
DESIGN NUMBER	322403-001		
CLASS	23-03		
HAVELLS INDIA LIMITED, 904, 9TH FLOOR, SURYA KIRAN BUILDING, K G MARG, CONNAUGHT PLACE, NEW DELHI – 110001			
DATE OF REGISTRATION	10/10/2019		
TITLE	WATER HEATER		
PRIORITY NA			
DESIGN NUMBER	322463-001		
CLASS	12-06		
DECATHLON, 4, BOULEVARD DE MONS 59650 VILLENEUVE D'ASCQ FRANCE			
DATE OF REGISTRATION	11/10/2019		
TITLE	BOAT HULL		
PRIORITY			
PRIORITY NUMBER	DATE	COUNTRY	
006375952-0004	12/04/2019	EUIPO	

DESIGN NUMBER	330743-001	
CLASS	09-01	
CHEMCO PLASTIC INDUSTRIES PVT. LTD., CHEMCO HOUSE, 6TH FLOOR, D SUKHADWALA ROAD FORT, MUMBAI 400001		
DATE OF REGISTRATION	04/07/2020	
TITLE	BOTTLE	
PRIORITY NA		
DESIGN NUMBER	330783-001	
CLASS	23-02	
MR. JANAK RASHMIKANT MEHTA, 8/1678, NANAD SHANKAR MAHOLLO, OPP. LALLUJI'S TEMPLE, GOPIPURA POLICE GATE LANE, SURAT – 395001, GUJARAT		
DATE OF REGISTRATION	06/07/2020	
TITLE	STAND FOR HAND SANITIZER AND SOAP DISPENSER	
PRIORITY NA		
DESIGN NUMBER	330841-001	
CLASS	02-02	
BHUMIKA DHARMESH ANGHAN, 61, MAHESHWAR NAGAR SOCIETY, NEAR BARODA PRISTAGE, VARACHHA ROAD, SURAT-395006		
DATE OF REGISTRATION	07/07/2020	
TITLE	SAREE	
PRIORITY NA		



DESIGN NUMBER	330848-002		
CLASS	23-01		
P. JAYAKUMAR, RESEARCH FACULTY, IRC – KALASALINGAM ACADEMY OF RESEARCH AND EDUCATION, ANAND NAGAR, KRISHNANKOIL - 626 126, SRIVILLIPUTTUR (VIA), VIRUDUNAGAR DISTRICT TAMILNADU, INDIA			
DATE OF REGISTRATION	08/07/2020		
TITLE	TOUCH FREE WATER DISPENSER		
PRIORITY NA			
DESIGN NUMBER	306717		
CLASS	12-11		
SWAMI VIVEKANAND SUBHARTI UNIVERSITY, NH-58, DELHI-HARIDWAR ,BYPASS ROAD, MEERUT - 250005, UTTAR PRADESH, INDIA			
DATE OF REGISTRATION	14/06/2018		
TITLE	TWIN BICYCLE		
PRIORITY NA			
DESIGN NUMBER	317635-001		
CLASS	12-08		
HONDA MOTOR CO., LTD., 1-1, MINAMI-AOYAMA 2-CHOME, MINATO-KU, TOKYO, 107-8556 JAPAN			
DATE OF REGISTRATION	11/05/2019		
TITLE	AUTOMOBILE		
PRIORITY			
PRIORITY NUMBER	DATE	COUNTRY	
2018-024929	15/11/2018	JAPAN	



DESIGN NUMBER	313527-008		
CLASS	12-16		
SCANIA CV AB, SE-151 87, SÖDERTÄLJE, SWEDEN			
DATE OF REGISTRATION	31/12/2018		
TITLE	STEP PLATE FOR VEHICLE		
PRIORITY			
PRIORITY NUMBER	DATE	COUNTRY	
2018/0176	06/07/2018	SWEDEN	
DESIGN NUMBER	313541-001		
CLASS	23-02		
KOHLER CO., 444 HIGHLAND DRIVE, KOHLER, WI 53044, UNITED STATES OF AMERICA			
DATE OF REGISTRATION	31/12/2018		
TITLE	HANDSHOWER		
PRIORITY			
PRIORITY NUMBER	DATE	COUNTRY	
29/662,264	04/09/2018	U.S.A.	
DESIGN NUMBER	313693-001		
CLASS	08-08		
GODREJ & BOYCE MANUFACTURING CO. LIMITED, NO. 1, SIDCO INDUSTRIAL ESTATE, AMBATTUR, CHENNAI-600098, INDIA			
DATE OF REGISTRATION	07/01/2019		
TITLE	ADJUSTABLE DIVIDER IN SHELVES FOR STORING PACKAGES		
PRIORITY NA			



DESIGN NUMBER	313726-005	
CLASS	09-01	
OKAYA POWER PVT. LTD., D-7, UDYOG NAGAR, ROHTAK ROAD, NEW DELHI-110041		
DATE OF REGISTRATION	09/01/2019	
TITLE	DISPENSER BOTTLE	
PRIORITY NA		
DESIGN NUMBER	313730-001	
CLASS	09-01	
M/S. M. M. PLASTOWARE (INDIA) PRIVATE LIMITED, OFF NO. # 12-15, ARIHANT DARSHAN, ABOVE IDBI BANK, 90 FEET ROAD, BHAYANDER (WEST), THANE - 401101, WHOSE DIRECTORS ARE 1. MR. NARESH MITHALAL JAIN, 2. MR. HEMANT MITHALAL JAIN, 3. MR. MUKESH MITHALAL JAIN, 4. MRS. SAVITA MITHALAL JAIN, 5. MRS. RASILA NARESH JAIN, 6. MRS. JYOTSHANA HEMANT JAIN & 7. MRS. DOLLY MUKESH JAIN		
DATE OF REGISTRATION	09/01/2019	
TITLE	INSULATING BOTTLE	
PRIORITY NA		
DESIGN NUMBER	323203-001	
CLASS	24-04	
KAMAL ENCON INDUSTRIES LIMITED, PLOT NO.917, SECTOR-68, IMT, FARIDABAD – 121 001, HARYANA, INDIA		
DATE OF REGISTRATION	02/11/2019	
TITLE	CORONARY STENT	
PRIORITY NA		



DESIGN NUMBER	323251-001		
CLASS	12-16		
VOLVO TRUCK CORPORATION, C/O VOLVO GROUP BUSINESS SERVICES, ARHK 5, AVD DC34320, 405 08 GÖTEBORG, SWEDEN			
DATE OF REGISTRATION	04/11/2019		
TITLE	DASHBOARDS FOR VEHICLES		
PRIORITY			
PRIORITY NUMBER	DATE	COUNTRY	
006435194-0028	09/05/2019	EUIPO	
DESIGN NUMBER	323304-001		
CLASS	23-05		
MANIPAL UNIVERSITY JAIPUR, OF DR MONIKA SOGANI, JAIPUR-AJMER EXPRESS HIGHWAY, DEHMI KALAN, NEAR GVK TOLL PLAZA, JAIPUR, RAJASTHAN 303007 INDIA			
DATE OF REGISTRATION	05/11/2019		
TITLE	MICROBIAL FUEL CELL WITH CORN-COB ANODE		
PRIORITY NA			
DESIGN NUMBER	323358-001		
CLASS	12-16		
VOLVO TRUCK CORPORATION, C/O VOLVO GROUP BUSINESS SERVICES, ARHK 5, AVD DC34320, 405 08 GÖTEBORG, SWEDEN			
DATE OF REGISTRATION	06/11/2019		
TITLE	VEHICLE DOOR		
PRIORITY			
PRIORITY NUMBER	DATE	COUNTRY	
006437133-0017	09/05/2019	EUIPO	



DESIGN NUMBER	323363-001		
CLASS	12-16		
VOLVO TRUCK CORPORATION, C/O VOLVO GROUP BUSINESS SERVICES, ARHK 5, AVD DC34320, 405 08 GÖTEBORG, SWEDEN			
DATE OF REGISTRATION	06/11/2019		
TITLE	PART OF VEHICLE DOORS		
PRIORITY			
PRIORITY NUMBER	DATE	COUNTRY	
006437133-0023	09/05/2019	EUIPO	
DESIGN NUMBER	323437-001		
CLASS	06-01		
1. ANNA ESWARA KUMAR, DEPARTMENT OF MECHANICAL ENGINEERING, KONERU LAKSHMAIAH EDUCATION FOUNDATION, GREEN FIELDS, VADDESWARAM, 522502 2. P. PRUDHVI TEJA, DEPARTMENT OF MECHANICAL ENGINEERING, KONERU LAKSHMAIAH EDUCATION FOUNDATION, GREEN FIELDS, VADDESWARAM, 522502 3. T. SRINIVASAN, DEPARTMENT OF MECHANICAL ENGINEERING, KONERU LAKSHMAIAH EDUCATION FOUNDATION, GREEN FIELDS, VADDESWARAM, 522502 4. G. DEEPAK KUMAR, DEPARTMENT OF MECHANICAL ENGINEERING, KONERU LAKSHMAIAH EDUCATION FOUNDATION, GREEN FIELDS, VADDESWARAM, 522502			
DATE OF REGISTRATION	08/11/2019		
TITLE	STRETCHER CUM WHEEL CHAIR		
PRIORITY NA			
DESIGN NUMBER	331386-001		
CLASS	12-08		
ŠKODA AUTO A.S., TR. VÁCLAVA KLEMENTA 869, MLADÁ BOLESLAV II CZ-29301 MLADÁ BOLESLAV, CZECH REPUBLIC			
DATE OF REGISTRATION	27/07/2020		
TITLE	AUTOMOBILE		
PRIORITY			
PRIORITY NUMBER	DATE	COUNTRY	
007654306-0001	03/02/2020	EUIPO	

DESIGN NUMBER	331429-001	
CLASS	23-01	
P. JAYAKUMAR, RESEARCH FACULTY, IRC – KALASALINGAM ACADEMY OF RESEARCH AND EDUCATION, ANAND NAGAR, KRISHNANKOIL - 626 126, SRIVILLIPUTTUR (VIA), VIRUDUNAGAR DISTRICT TAMILNADU, INDIA		
DATE OF REGISTRATION	28/07/2020	
TITLE	PORTABLE PVC FOOT OPERABLE WATER DISPENSER	
PRIORITY NA		
DESIGN NUMBER	331451-006	
CLASS	11-02	
AMARPAL SINGH KHURANA, A-349, MEERA BAGH, OUTER RING ROAD, NEW DELHI-110087		
DATE OF REGISTRATION	29/07/2020	
TITLE	PLANT POT	
PRIORITY NA		
DESIGN NUMBER	331489-001	
CLASS	09-01	
ROCK AND STORM BOTTLERS PVT. LTD., PLOT NO - 214, INDUSTRIAL AREA, PHASE-1, CHANDIGARH, INDIA		
DATE OF REGISTRATION	30/07/2020	
TITLE	BOTTLE	
PRIORITY NA		

DESIGN NUMBER	324490-001	
CLASS	25-01	
BHARAT FLOORINGS & TILES (MUMBAI) PVT LTD, 32, MUMBAI SAMACHAR MARG, FORT, MUMBAI-400023, STATE OF MAHARASHTRA, INDIA		
DATE OF REGISTRATION	07/12/2019	
TITLE	TILE	
PRIORITY NA		
DESIGN NUMBER	331605-001	
CLASS	09-01	
M/S. NECTAR FOOD & BEVERAGES, 70/ NEMINATH NAGAR, NEAR MODEL TOWN PARVAT PATIYA, SURAT - 395010, GUJARAT, INDIA, WHOSE PARTNERS ARE (1) RAJESH DHANJIBHAI VEKARIYA (2) DHANJIBHAI HIRJIBHAI VEKARIYA (3) KANTABEN DHANJIBHAI VEKARIYA & (4) MINAXI RAJESHBHAI VEKARIYA		
DATE OF REGISTRATION	03/08/2020	
TITLE	BOTTLE	
PRIORITY NA		
DESIGN NUMBER	317256-001	
CLASS	12-11	
SACHIN ANANT JADHAV, A-5 ECHINUS COURT NEAR MITCON INSTITUTE, BALEWADI PUNE-45		
DATE OF REGISTRATION	27/04/2019	
TITLE	VEHICLE FRAME	
PRIORITY NA		

DESIGN NUMBER	317257-001		
CLASS	12-11		
SACHIN ANANT JADHAV, A-5 ECHINUS COURT NEAR MITCON INSTITUTE, BALEWADI PUNE-45			
DATE OF REGISTRATION	27/04/2019		
TITLE	VEHICLE FRAME		
PRIORITY NA			
DESIGN NUMBER	325684-001		
CLASS	30-03		
FRANCISCO JAVIER SEPTIEN PRIETO, PONIENTE 6 NO. 133 CIUDAD INDUSTRIAL, CELAYA, GUANAJUATO MEXICO 38010			
DATE OF REGISTRATION	08/01/2020		
TITLE	FEEDER FOR CHICKS		
PRIORITY			
PRIORITY NUMBER	DATE	COUNTRY	
MX/F/2019/001854	11/07/2019	MEXICO	
DESIGN NUMBER	325860-001		
CLASS	23-04		
AKSHAY DHOOT, GUT NO. 19415, RAILWAY STATION ROAD, RTO OFFICE, BANSILAL NAGAR, AURANGABAD-431001 MAHARASHTRA.			
DATE OF REGISTRATION	13/01/2020		
TITLE	AIR COOLER		
PRIORITY NA			

DESIGN NUMBER	315981-001		
CLASS	11-05		
HIREN PRATAP SHAH, YES CREATION- SHOP NO. 7, JAI SAKET SOCIETY, OPP VIJAYA BHAVAN, RAIPADA, MALAD (W), MUMBAI-400064			
DATE OF REGISTRATION	22/03/2019		
TITLE	FESTIVE DECORATIVE ARTICLE		
PRIORITY NA			
DESIGN NUMBER	316033-001		
CLASS	12-16		
BHARAT HEAVY ELECTRICALS LIMITED, REGIONAL OPERATIONS DIVISION (ROD), PLOT NO. 9/1, DJ BLOCK, 3RD FLOOR, KARUNAMOYEE, SALTLAKE CITY, KOLKATA- 700091, REGISTERED OFFICE AT BHEL HOUSE SIRI FORT, NEW DELHI – 110049, INDIA			
DATE OF REGISTRATION	25/03/2019		
TITLE	FRONT WHEEL OF TEMPLE CAR		
PRIORITY NA			
DESIGN NUMBER	316202-004		
CLASS	09-03		
CHUBBY GORILLA, INC., 10425 SLUSHER DRIVE, SANTA FE SPRINGS, CA, 90670, USA			
DATE OF REGISTRATION	29/03/2019		
TITLE	CONTAINER		
PRIORITY			
PRIORITY NUMBER	DATE	COUNTRY	
US 29/665,474	03/10/2018	U.S.A.	

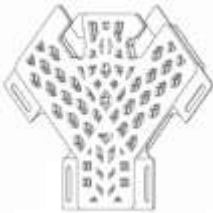

DESIGN NUMBER	326553-001	
CLASS	25-02	
DIGVIJAY SINGH DHABRIYA, A-41-42, JAI JAWAN COLONY, J.L.N. MARG, JAIPUR - 302017, RAJASTHAN, INDIA		
DATE OF REGISTRATION	29/01/2020	
TITLE	MOLDING FOR BUILDING PARTS	
PRIORITY NA		
DESIGN NUMBER	326613-001	
CLASS	02-04	
RELAXO FOOTWEARS LIMITED, AGGARWAL CITY SQUARE, PLOT NO. 10, DISTRICT CENTRE, MANGALAM PLACE, SECTOR-03, ROHINI, DELHI-110085, INDIA		
DATE OF REGISTRATION	30/01/2020	
TITLE	FOOTWEAR	
PRIORITY NA		
DESIGN NUMBER	326680-001	
CLASS	24-04	
DR. PANKAJKUMAR K CHHATRALA, PLOT NO 96, PRAMUKH SWAMI NAGAR, SARA ROAD, HALVAD, SURENDRA NAGAR – 363330, GUJARAT, INDIA		
DATE OF REGISTRATION	01/02/2020	
TITLE	ORTHOPEDIC THUMB SPLINT	
PRIORITY NA		



DESIGN NUMBER	315683-001	
CLASS	09-01	
PEARL POLYMERS LIMITED, A-97/2, OKHLA INDUSTRIAL AREA, PHASE 2, NEW DELHI – 110 020, INDIA		
DATE OF REGISTRATION	13/03/2019	
TITLE	JAR	
PRIORITY NA		
DESIGN NUMBER	315727-001	
CLASS	02-04	
RELAXO FOOTWEARS LIMITED, AGGARWAL CITY SQUARE, PLOT NO. 10, MANGLAM PLACE, DISTRICT CENTRE, SECTOR – 3, ROHINI, DELHI 110085		
DATE OF REGISTRATION	13/03/2019	
TITLE	FOOTWEAR	
PRIORITY NA		
DESIGN NUMBER	325258-001	
CLASS	02-02	
SABYASACHI COUTURE, 86C, JATIN DAS ROAD, KOLKATA-700029, STATE OF WEST BENGAL, WHOSE PARTNERS ARE MR. SUKUMAR MUKHERJEE AND MR. SABYASACHI MUKHERJEE.		
DATE OF REGISTRATION	31/12/2019	
TITLE	GARMENT (SET)	
PRIORITY NA		



DESIGN NUMBER	325264-001	
CLASS	02-02	
SABYASACHI COUTURE, 86C, JATIN DAS ROAD, KOLKATA-700029, STATE OF WEST BENGAL, WHOSE PARTNERS ARE MR. SUKUMAR MUKHERJEE AND MR. SABYASACHI MUKHERJEE.		
DATE OF REGISTRATION	31/12/2019	
TITLE	GARMENT (SET)	
PRIORITY NA		
DESIGN NUMBER	313212-006	
CLASS	06-11	
EXMART INTERNATIONAL PVT. LTD., 268, SANT NAGAR, EAST OF KAILASH, NEW DELHI- 110065, INDIA		
DATE OF REGISTRATION	19/12/2018	
TITLE	MATS	
PRIORITY NA		
DESIGN NUMBER	322490-001	
CLASS	06-06	
NILESH RAVINDRANATH NILUR, 88, BHAVDEEP PARK SOCIETY, GOR NO KUVO, MANINAGAR (EAST) - AHMEDABAD, GUJARAT - 380008		
DATE OF REGISTRATION	14/10/2019	
TITLE	ALUMINIUM TRIANGLE (TA) BRACKET FOR FURNITURE	
PRIORITY NA		



DESIGN NUMBER	322517-001	
CLASS	12-16	
BAJAJ AUTO LIMITED, MUMBAI-PUNE ROAD, AKURDI, PUNE-411035		
DATE OF REGISTRATION	15/10/2019	
TITLE	LUGGAGE HOOK FOR MOTOR SCOOTER	
PRIORITY NA		
DESIGN NUMBER	322581-001	
CLASS	02-04	
RELAXO FOOTWEARS LIMITED, AGGARWAL CITY SQUARE, PLOT NO. 10, MANGLAM PLACE, DISTRICT CENTRE, SECTOR – 3, ROHINI, DELHI 110085		
DATE OF REGISTRATION	16/10/2019	
TITLE	FOOTWEAR	
PRIORITY NA		
DESIGN NUMBER	322582-001	
CLASS	02-04	
RELAXO FOOTWEARS LIMITED, AGGARWAL CITY SQUARE, PLOT NO. 10, MANGLAM PLACE, DISTRICT CENTRE, SECTOR – 3, ROHINI, DELHI 110085		
DATE OF REGISTRATION	16/10/2019	
TITLE	FOOTWEAR	
PRIORITY NA		

DESIGN NUMBER	322593-001	
CLASS	23-04	
HAVELLS INDIA LIMITED, 904, 9TH FLOOR, SURYA KIRAN BUILDING, K G MARG, CONNAUGHT PLACE, NEW DELHI – 110001		
DATE OF REGISTRATION	17/10/2019	
TITLE	AIR COOLER	
PRIORITY NA		
DESIGN NUMBER	322617-001	
CLASS	09-01	
CELLO HOUSEHOLD PRODUCTS, CORPORATE AVENUE, 'B' WING, CELLO HOUSE, SONAWALA ROAD, GOREGAON (EAST), MUMBAI-400 063, MAHARASHTRA, INDIA		
DATE OF REGISTRATION	17/10/2019	
TITLE	FLASK	
PRIORITY NA		
DESIGN NUMBER	322624-001	
CLASS	23-04	
HAVELLS INDIA LIMITED, 904, 9TH FLOOR, SURYA KIRAN BUILDING, K.G. MARG, CONNAUGHT PLACE, NEW DELHI-110001, INDIA		
DATE OF REGISTRATION	18/10/2019	
TITLE	CEILING FAN	
PRIORITY NA		



DESIGN NUMBER	322659-001	
CLASS	05-05	
BIBA APPARELS PRIVATE LIMITED, NO.4, GROUND FLOOR, DELSTAR PREMISES CHS NS PATKAR MARG, HUGES ROAD, KEMPS CORNER, MUMBAI – 400036 AND CORPORATE OFFICE AT 12TH & 13TH FLOOR CAPITAL CYBERSCAPE, SECTOR-59 GOLF COURSE EXTENSION ROAD,GURUGRAM-122102 HARYANA, INDIA.		
DATE OF REGISTRATION	18/10/2019	
TITLE	TEXTILE FABRIC	
PRIORITY NA		
DESIGN NUMBER	322668-001	
CLASS	05-05	
BIBA APPARELS PRIVATE LIMITED, NO.4, GROUND FLOOR, DELSTAR PREMISES CHS NS PATKAR MARG, HUGES ROAD, KEMPS CORNER, MUMBAI – 400036 AND CORPORATE OFFICE AT 12TH & 13TH FLOOR CAPITAL CYBERSCAPE, SECTOR-59 GOLF COURSE EXTENSION ROAD,GURUGRAM-122102 HARYANA, INDIA.		
DATE OF REGISTRATION	18/10/2019	
TITLE	TEXTILE FABRIC	
PRIORITY NA		
DESIGN NUMBER	322671-001	
CLASS	05-05	
BIBA APPARELS PRIVATE LIMITED, NO.4, GROUND FLOOR, DELSTAR PREMISES CHS NS PATKAR MARG, HUGES ROAD, KEMPS CORNER, MUMBAI – 400036 AND CORPORATE OFFICE AT 12TH & 13TH FLOOR CAPITAL CYBERSCAPE, SECTOR-59 GOLF COURSE EXTENSION ROAD,GURUGRAM-122102 HARYANA, INDIA.		
DATE OF REGISTRATION	18/10/2019	
TITLE	TEXTILE FABRIC	
PRIORITY NA		



DESIGN NUMBER	322679-001	
CLASS	05-05	
BIBA APPARELS PRIVATE LIMITED, NO.4, GROUND FLOOR, DELSTAR PREMISES CHS NS PATKAR MARG, HUGES ROAD, KEMPS CORNER, MUMBAI – 400036 AND CORPORATE OFFICE AT 12TH & 13TH FLOOR CAPITAL CYBERSCAPE, SECTOR-59 GOLF COURSE EXTENSION ROAD,GURUGRAM-122102 HARYANA, INDIA.		
DATE OF REGISTRATION	18/10/2019	
TITLE	TEXTILE FABRIC	
PRIORITY NA		
DESIGN NUMBER	322688-001	
CLASS	05-05	
BIBA APPARELS PRIVATE LIMITED, NO.4, GROUND FLOOR, DELSTAR PREMISES CHS NS PATKAR MARG, HUGES ROAD, KEMPS CORNER, MUMBAI – 400036 AND CORPORATE OFFICE AT 12TH & 13TH FLOOR CAPITAL CYBERSCAPE, SECTOR-59 GOLF COURSE EXTENSION ROAD,GURUGRAM-122102 HARYANA, INDIA.		
DATE OF REGISTRATION	18/10/2019	
TITLE	TEXTILE FABRIC	
PRIORITY NA		
DESIGN NUMBER	322693-001	
CLASS	05-05	
BIBA APPARELS PRIVATE LIMITED, NO.4, GROUND FLOOR, DELSTAR PREMISES CHS NS PATKAR MARG, HUGES ROAD, KEMPS CORNER, MUMBAI – 400036 AND CORPORATE OFFICE AT 12TH & 13TH FLOOR CAPITAL CYBERSCAPE, SECTOR-59 GOLF COURSE EXTENSION ROAD,GURUGRAM-122102 HARYANA, INDIA.		
DATE OF REGISTRATION	18/10/2019	
TITLE	TEXTILE FABRIC	
PRIORITY NA		

DESIGN NUMBER	322694-001	
CLASS	05-05	
BIBA APPARELS PRIVATE LIMITED, NO.4, GROUND FLOOR, DELSTAR PREMISES CHS NS PATKAR MARG, HUGES ROAD, KEMPS CORNER, MUMBAI – 400036 AND CORPORATE OFFICE AT 12TH & 13TH FLOOR CAPITAL CYBERSCAPE, SECTOR-59 GOLF COURSE EXTENSION ROAD,GURUGRAM-122102 HARYANA, INDIA.		
DATE OF REGISTRATION	18/10/2019	
TITLE	TEXTILE FABRIC	
PRIORITY NA		
DESIGN NUMBER	322699-001	
CLASS	05-05	
BIBA APPARELS PRIVATE LIMITED, NO.4, GROUND FLOOR, DELSTAR PREMISES CHS NS PATKAR MARG, HUGES ROAD, KEMPS CORNER, MUMBAI – 400036 AND CORPORATE OFFICE AT 12TH & 13TH FLOOR CAPITAL CYBERSCAPE, SECTOR-59 GOLF COURSE EXTENSION ROAD,GURUGRAM-122102 HARYANA, INDIA.		
DATE OF REGISTRATION	18/10/2019	
TITLE	TEXTILE FABRIC	
PRIORITY NA		
DESIGN NUMBER	322705-001	
CLASS	05-05	
BIBA APPARELS PRIVATE LIMITED, NO.4, GROUND FLOOR, DELSTAR PREMISES CHS NS PATKAR MARG, HUGES ROAD, KEMPS CORNER, MUMBAI – 400036 AND CORPORATE OFFICE AT 12TH & 13TH FLOOR CAPITAL CYBERSCAPE, SECTOR-59 GOLF COURSE EXTENSION ROAD,GURUGRAM-122102 HARYANA, INDIA.		
DATE OF REGISTRATION	18/10/2019	
TITLE	TEXTILE FABRIC	
PRIORITY NA		

DESIGN NUMBER	322708-001	
CLASS	05-05	
BIBA APPARELS PRIVATE LIMITED, NO.4, GROUND FLOOR, DELSTAR PREMISES CHS NS PATKAR MARG, HUGES ROAD, KEMPS CORNER, MUMBAI – 400036 AND CORPORATE OFFICE AT 12TH & 13TH FLOOR CAPITAL CYBERSCAPE, SECTOR-59 GOLF COURSE EXTENSION ROAD,GURUGRAM-122102 HARYANA, INDIA.		
DATE OF REGISTRATION	18/10/2019	
TITLE	TEXTILE FABRIC	
PRIORITY NA		
DESIGN NUMBER	322712-001	
CLASS	05-05	
BIBA APPARELS PRIVATE LIMITED, NO.4, GROUND FLOOR, DELSTAR PREMISES CHS NS PATKAR MARG, HUGES ROAD, KEMPS CORNER, MUMBAI – 400036 AND CORPORATE OFFICE AT 12TH & 13TH FLOOR CAPITAL CYBERSCAPE, SECTOR-59 GOLF COURSE EXTENSION ROAD,GURUGRAM-122102 HARYANA, INDIA.		
DATE OF REGISTRATION	18/10/2019	
TITLE	TEXTILE FABRIC	
PRIORITY NA		
DESIGN NUMBER	322760-001	
CLASS	05-05	
BIBA APPARELS PRIVATE LIMITED, NO.4, GROUND FLOOR, DELSTAR PREMISES CHS NS PATKAR MARG, HUGES ROAD, KEMPS CORNER, MUMBAI – 400036 AND CORPORATE OFFICE AT 12TH & 13TH FLOOR CAPITAL CYBERSCAPE, SECTOR-59 GOLF COURSE EXTENSION ROAD,GURUGRAM-122102 HARYANA, INDIA.		
DATE OF REGISTRATION	18/10/2019	
TITLE	TEXTILE FABRIC	
PRIORITY NA		

DESIGN NUMBER	322764-001	
CLASS	05-05	
BIBA APPARELS PRIVATE LIMITED, NO.4, GROUND FLOOR, DELSTAR PREMISES CHS NS PATKAR MARG, HUGES ROAD, KEMPS CORNER, MUMBAI – 400036 AND CORPORATE OFFICE AT 12TH & 13TH FLOOR CAPITAL CYBERSCAPE, SECTOR-59 GOLF COURSE EXTENSION ROAD,GURUGRAM-122102 HARYANA, INDIA		
DATE OF REGISTRATION	18/10/2019	
TITLE	TEXTILE FABRIC	
PRIORITY NA		
DESIGN NUMBER	322766-001	
CLASS	05-05	
BIBA APPARELS PRIVATE LIMITED, NO.4, GROUND FLOOR, DELSTAR PREMISES CHS NS PATKAR MARG, HUGES ROAD, KEMPS CORNER, MUMBAI – 400036 AND CORPORATE OFFICE AT 12TH & 13TH FLOOR CAPITAL CYBERSCAPE, SECTOR-59 GOLF COURSE EXTENSION ROAD,GURUGRAM-122102 HARYANA, INDIA		
DATE OF REGISTRATION	18/10/2019	
TITLE	TEXTILE FABRIC	
PRIORITY NA		
DESIGN NUMBER	322767-001	
CLASS	05-05	
BIBA APPARELS PRIVATE LIMITED, NO.4, GROUND FLOOR, DELSTAR PREMISES CHS NS PATKAR MARG, HUGES ROAD, KEMPS CORNER, MUMBAI – 400036 AND CORPORATE OFFICE AT 12TH & 13TH FLOOR CAPITAL CYBERSCAPE, SECTOR-59 GOLF COURSE EXTENSION ROAD,GURUGRAM-122102 HARYANA, INDIA		
DATE OF REGISTRATION	18/10/2019	
TITLE	TEXTILE FABRIC	
PRIORITY NA		

DESIGN NUMBER	322768-001	
CLASS	05-05	
BIBA APPARELS PRIVATE LIMITED, NO.4, GROUND FLOOR, DELSTAR PREMISES CHS NS PATKAR MARG, HUGES ROAD, KEMPS CORNER, MUMBAI – 400036 AND CORPORATE OFFICE AT 12TH & 13TH FLOOR CAPITAL CYBERSCAPE, SECTOR-59 GOLF COURSE EXTENSION ROAD,GURUGRAM-122102 HARYANA, INDIA.		
DATE OF REGISTRATION	18/10/2019	
TITLE	TEXTILE FABRIC	
PRIORITY NA		
DESIGN NUMBER	322770-001	
CLASS	05-05	
BIBA APPARELS PRIVATE LIMITED, NO.4, GROUND FLOOR, DELSTAR PREMISES CHS NS PATKAR MARG, HUGES ROAD, KEMPS CORNER, MUMBAI – 400036 AND CORPORATE OFFICE AT 12TH & 13TH FLOOR CAPITAL CYBERSCAPE, SECTOR-59 GOLF COURSE EXTENSION ROAD,GURUGRAM-122102 HARYANA, INDIA.		
DATE OF REGISTRATION	18/10/2019	
TITLE	TEXTILE FABRIC	
PRIORITY NA		
DESIGN NUMBER	322774-001	
CLASS	05-05	
BIBA APPARELS PRIVATE LIMITED, NO.4, GROUND FLOOR, DELSTAR PREMISES CHS NS PATKAR MARG, HUGES ROAD, KEMPS CORNER, MUMBAI – 400036 AND CORPORATE OFFICE AT 12TH & 13TH FLOOR CAPITAL CYBERSCAPE, SECTOR-59 GOLF COURSE EXTENSION ROAD,GURUGRAM-122102 HARYANA, INDIA.		
DATE OF REGISTRATION	18/10/2019	
TITLE	TEXTILE FABRIC	
PRIORITY NA		

DESIGN NUMBER	322775-001	
CLASS	05-05	
BIBA APPARELS PRIVATE LIMITED, NO.4, GROUND FLOOR, DELSTAR PREMISES CHS NS PATKAR MARG, HUGES ROAD, KEMPS CORNER, MUMBAI – 400036 AND CORPORATE OFFICE AT 12TH & 13TH FLOOR CAPITAL CYBERSCAPE, SECTOR-59 GOLF COURSE EXTENSION ROAD,GURUGRAM-122102 HARYANA, INDIA.		
DATE OF REGISTRATION	18/10/2019	
TITLE	TEXTILE FABRIC	
PRIORITY NA		
DESIGN NUMBER	322777-001	
CLASS	05-05	
BIBA APPARELS PRIVATE LIMITED, NO.4, GROUND FLOOR, DELSTAR PREMISES CHS NS PATKAR MARG, HUGES ROAD, KEMPS CORNER, MUMBAI – 400036 AND CORPORATE OFFICE AT 12TH & 13TH FLOOR CAPITAL CYBERSCAPE, SECTOR-59 GOLF COURSE EXTENSION ROAD,GURUGRAM-122102 HARYANA, INDIA.		
DATE OF REGISTRATION	18/10/2019	
TITLE	TEXTILE FABRIC	
PRIORITY NA		
DESIGN NUMBER	322815-001	
CLASS	03-01	
SABYASACHI COUTURE, 86C, JATIN DAS ROAD, KOLKATA-700029, STATE OF WEST BENGAL, WHOSE PARTNERS ARE MR. SUKUMAR MUKHERJEE AND MR. SABYASACHI MUKHERJEE.		
DATE OF REGISTRATION	21/10/2019	
TITLE	BAG	
PRIORITY NA		

DESIGN NUMBER	313902-001	
CLASS	06-03	
PANKAJ DHINGRA, JUMPING INTERNATIONAL, SRIRAMPURA, ROYAL ENCLAVE APARTMENTS, NEAR RACHNEHALLI LAKE, JAKKUR, BANGALORE, KARNATAKA, 560064, INDIA		
DATE OF REGISTRATION	16/01/2019	
TITLE	FLY DINNING TABLE SET	
PRIORITY NA		
DESIGN NUMBER	324788-001	
CLASS	02-04	
RELAXO FOOTWEARS LIMITED, AGGARWAL CITY SQUARE, PLOT NO. 10, MANGLAM PLACE, DISTRICT CENTRE, SECTOR – 3, ROHINI, DELHI 110085		
DATE OF REGISTRATION	17/12/2019	
TITLE	FOOTWEAR	
PRIORITY NA		
DESIGN NUMBER	324876-002	
CLASS	06-01	
SARAL PLASTIC INDUSTRIES, SR NO. 24, PLOT NO, 4, SHAPAR MAIN ROAD, SHAPAR (VERAVAL), DIST: RAJKOT-360024		
DATE OF REGISTRATION	19/12/2019	
TITLE	CHAIR	
PRIORITY NA		

DESIGN NUMBER	324986-001	
CLASS	23-04	
MITA ASHOK KAPOOR, 1, SCENIC ACRES, VAPI CHALA ROAD, VAPI - 396191, GUJARAT, INDIA		
DATE OF REGISTRATION	24/12/2019	
TITLE	AIR COOLER	
PRIORITY NA		
DESIGN NUMBER	331911-009	
CLASS	06-04	
NAB.SATHIYA NARAYANAN, NO. 15, SOWBHAGYA NAGAR "A" BLOCK, CIVIL AERODROME POST, COIMBATORE - 641 014 TAMIL NADU, INDIA		
DATE OF REGISTRATION	13/08/2020	
TITLE	BOOK SHELF	
PRIORITY NA		
DESIGN NUMBER	331911-010	
CLASS	06-04	
NAB.SATHIYA NARAYANAN, NO. 15, SOWBHAGYA NAGAR A BLOCK, CIVIL AERODROME POST, COIMBATORE - 641 014 TAMIL NADU, INDIA		
DATE OF REGISTRATION	13/08/2020	
TITLE	BOOK SHELF	
PRIORITY NA		